

Porto. Tech Hub In Lego

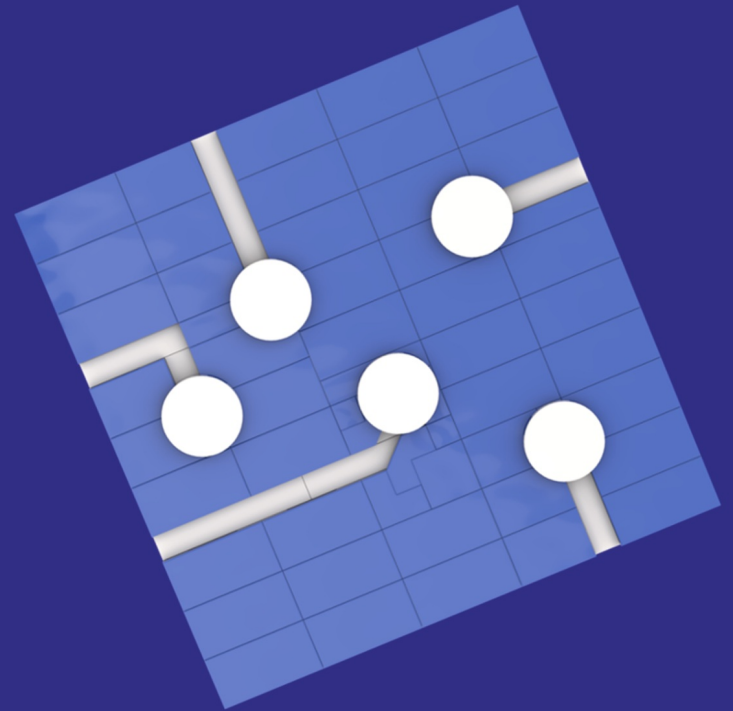

Model instructions by Bird Brick Builds
Author: Eduardo Sousa
172 Parts

About PTH:

"A non-profit private association of technology companies aims to promote the Porto region as a center of excellence and innovation in technology. The objectives include promoting cooperation among entities related to Information Technology (IT) and promoting capacity building and dissemination of knowledge in the IT field."

PTH MANIFESTO:

Leadership Center. We ensure that Porto is a center of leadership and excellence in innovation.

People. We believe that people are a unique source of talent, creativity, and passion.

Community. We value each of our talents through a strong community that shares ideas.

Technologies. We have cutting-edge technologies incorporated into our genetic code.

Harmony. We live in a place where technology, work, and lifestyle choices come together in perfect harmony.

PTH ACTIONS:

Organize and promote social, educational, cultural, and solidarity events or activities.

Create a network of contacts between technology companies and institutions, aiming to build a more active and cooperative ecosystem.

Promote case studies and their dissemination.



Attribution-NonCommercial-ShareAlike 4.0 International (CC BY-NC-SA 4.0)

This is a human-readable summary of (and not a substitute for) the [license](#). [Disclaimer](#).

You are free to:

Share — copy and redistribute the material in any medium or format

Adapt — remix, transform, and build upon the material

The licensor cannot revoke these freedoms as long as you follow the license terms.

Under the following terms:



Attribution — You must give [appropriate credit](#), provide a link to the license, and [indicate if changes were made](#). You may do so in any reasonable manner, but not in any way that suggests the licensor endorses you or your use.



NonCommercial — You may not use the material for [commercial purposes](#).



ShareAlike — If you remix, transform, or build upon the material, you must distribute your contributions under the [same license](#) as the original.

No additional restrictions — You may not apply legal terms or [technological measures](#) that legally restrict others from doing anything the license permits.

Notices:

You do not have to comply with the license for elements of the material in the public domain or where your use is permitted by an applicable [exception or limitation](#).

No warranties are given. The license may not give you all of the permissions necessary for your intended use. For example, other rights such as [publicity, privacy, or moral rights](#) may limit how you use the material.

1

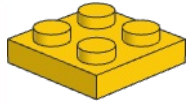

1x

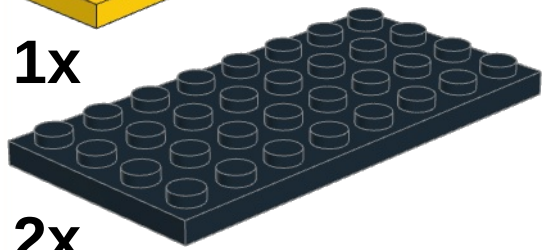

2x

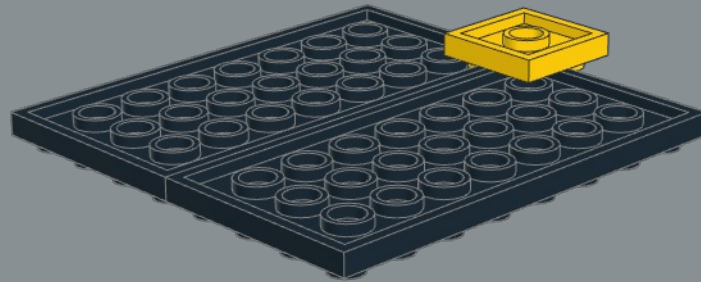

2

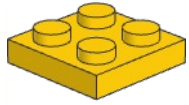

1x

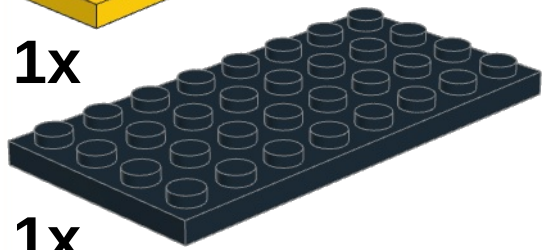

1x

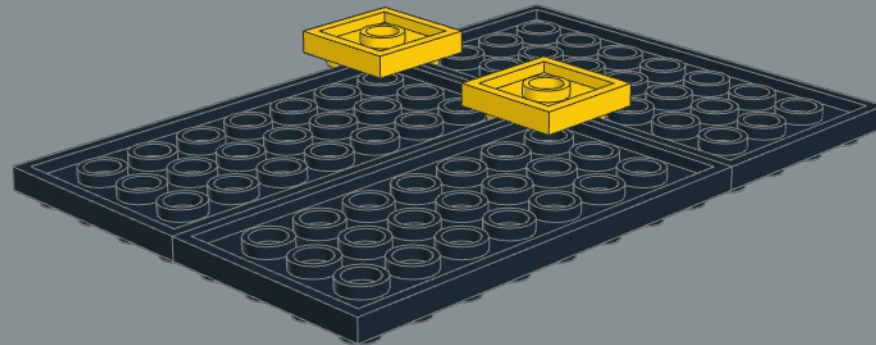

3

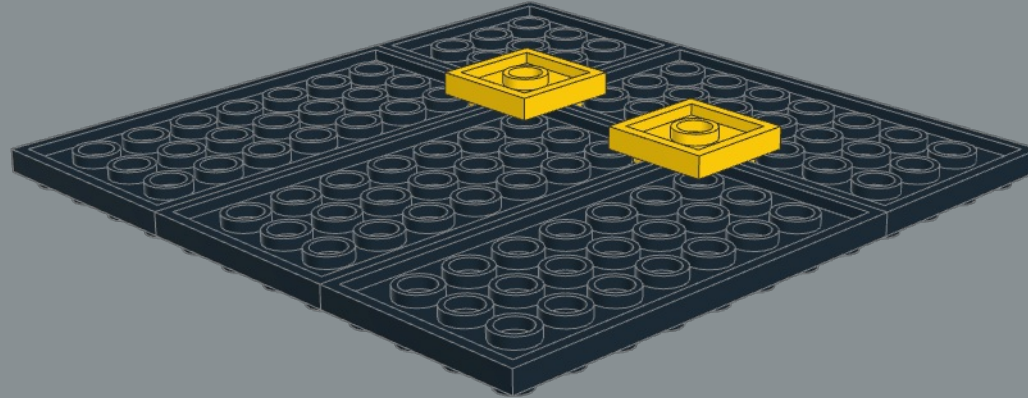
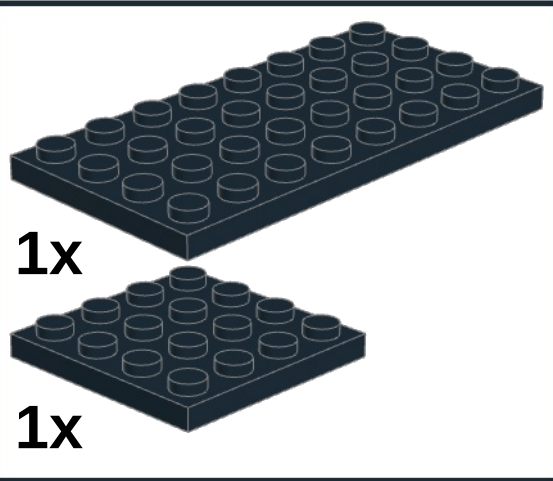

4

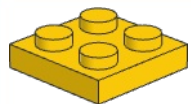

1x

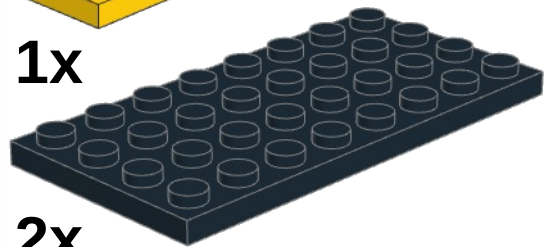

2x

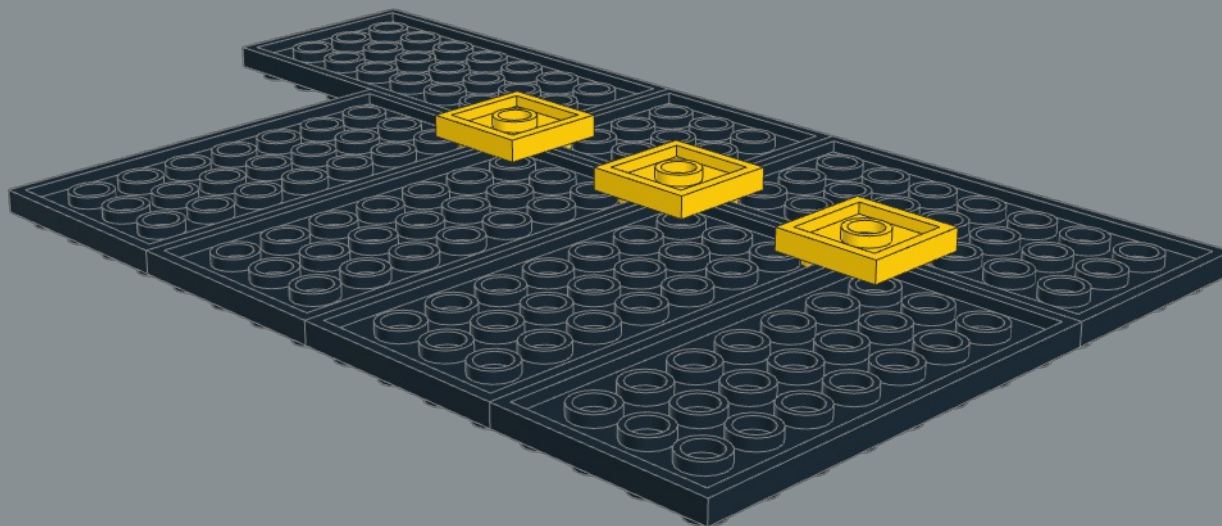

5

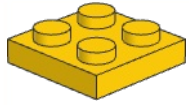

1x

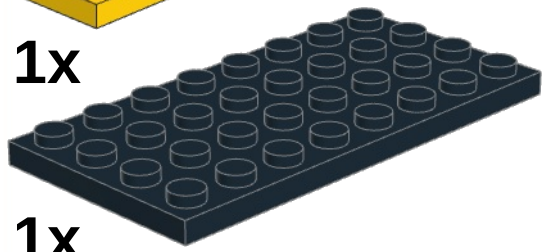

1x

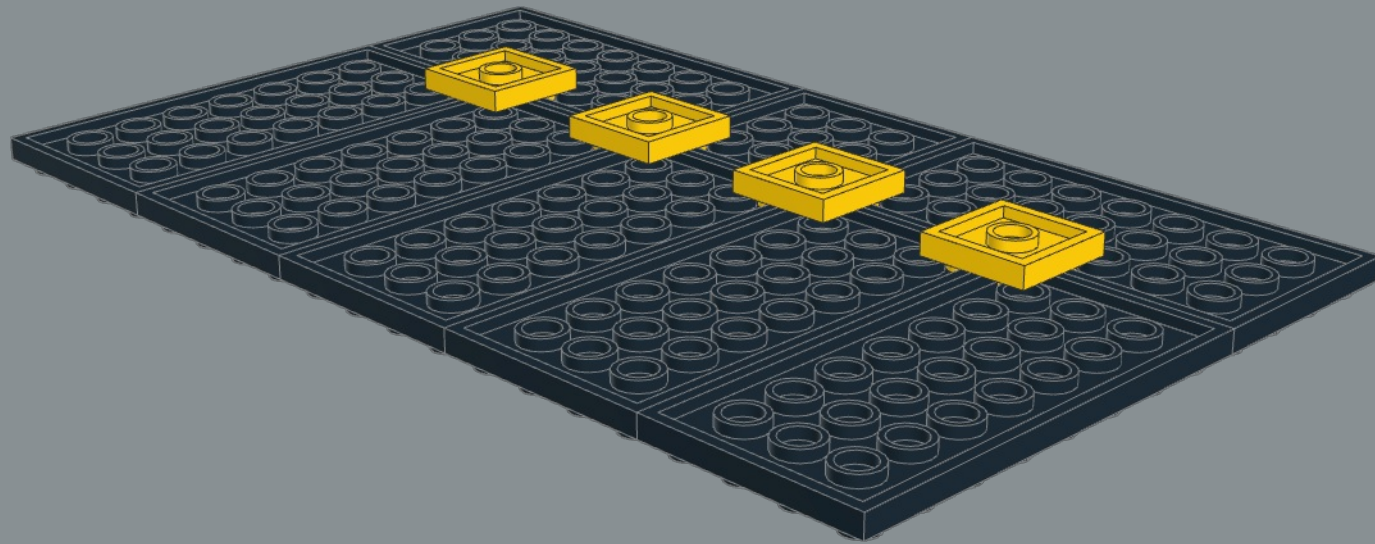

6

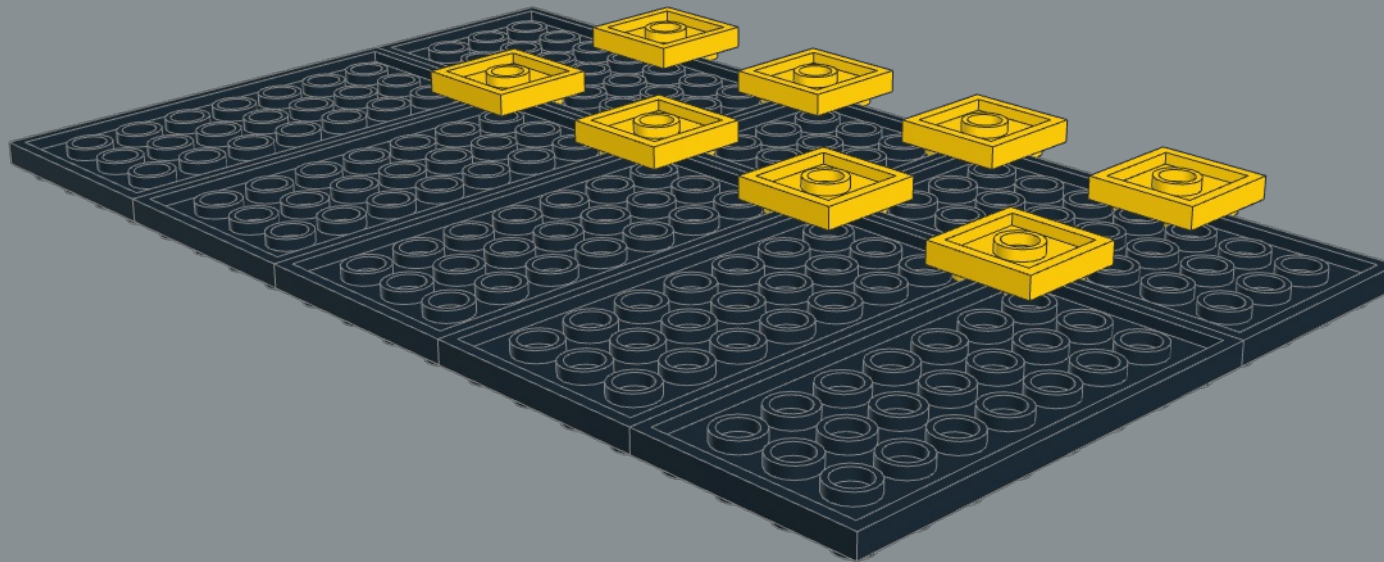
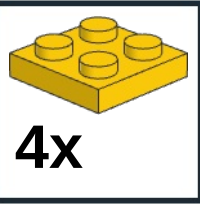

7

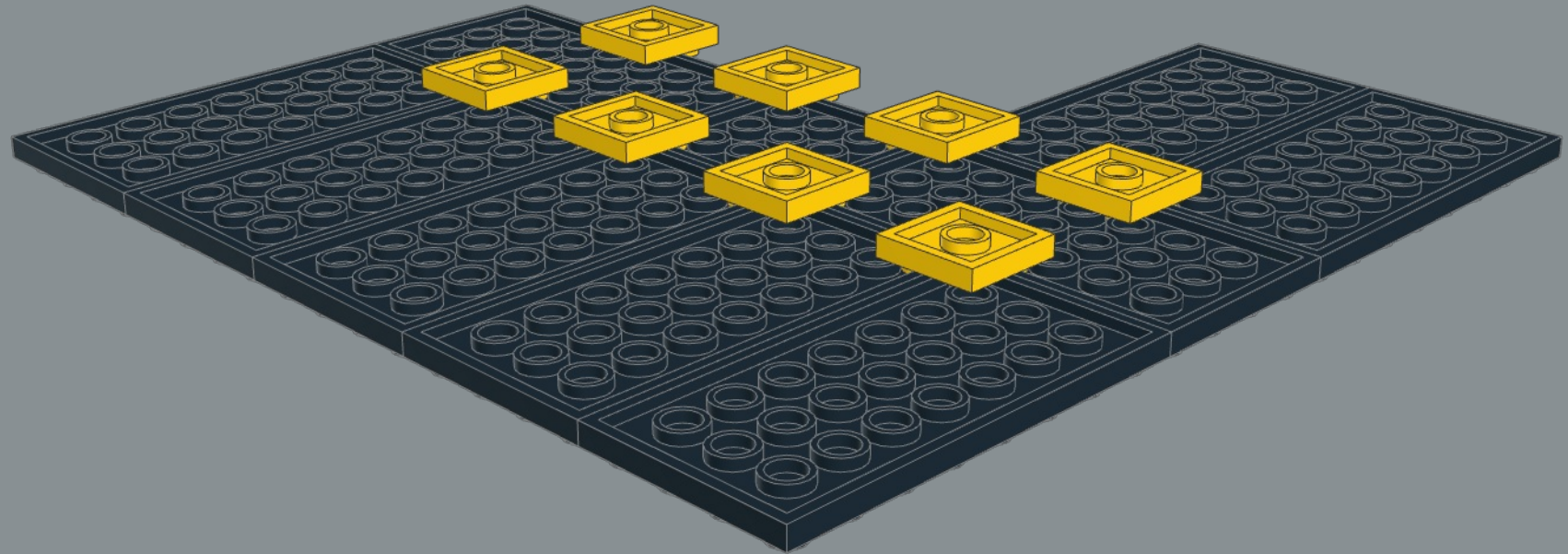
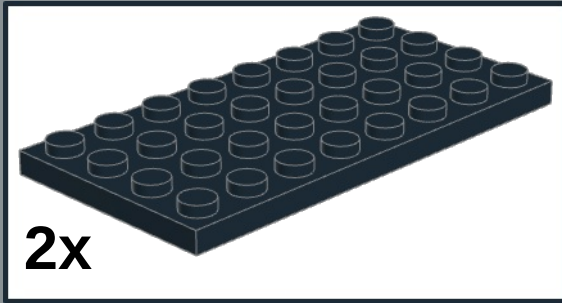

8

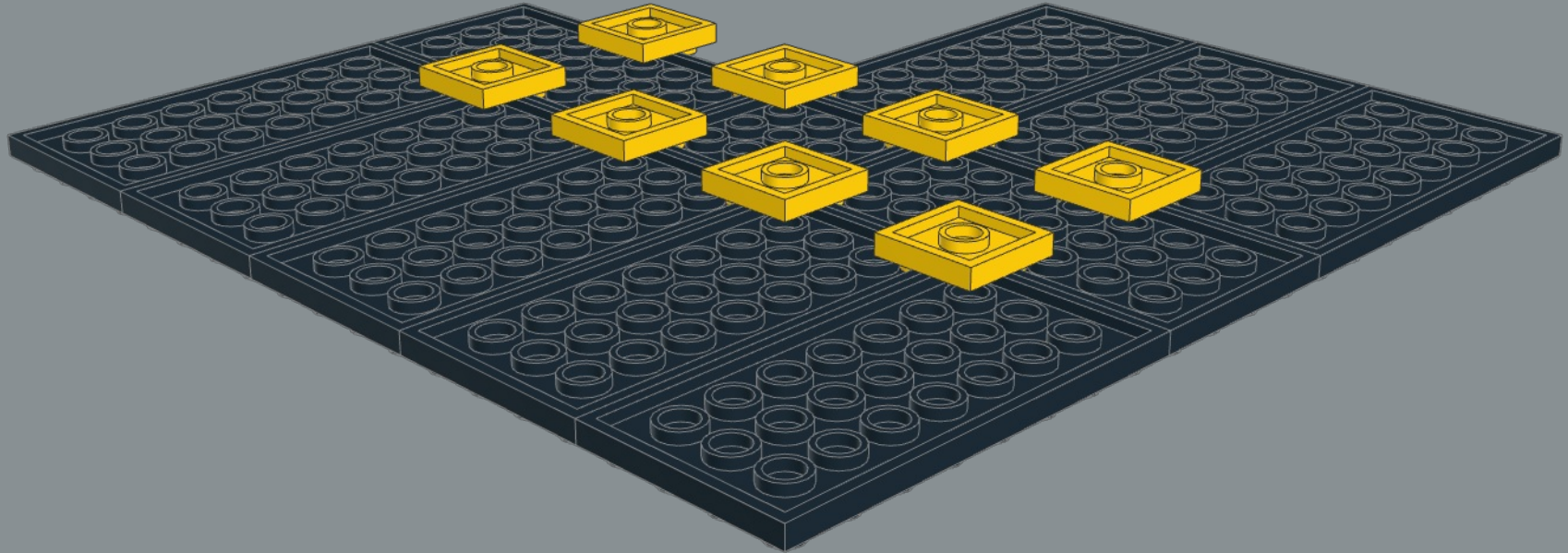
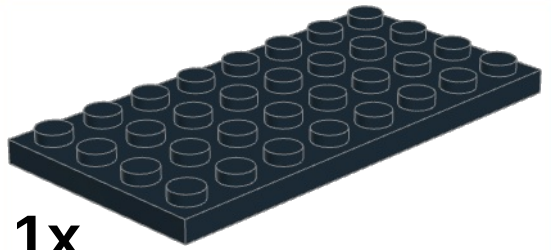

9

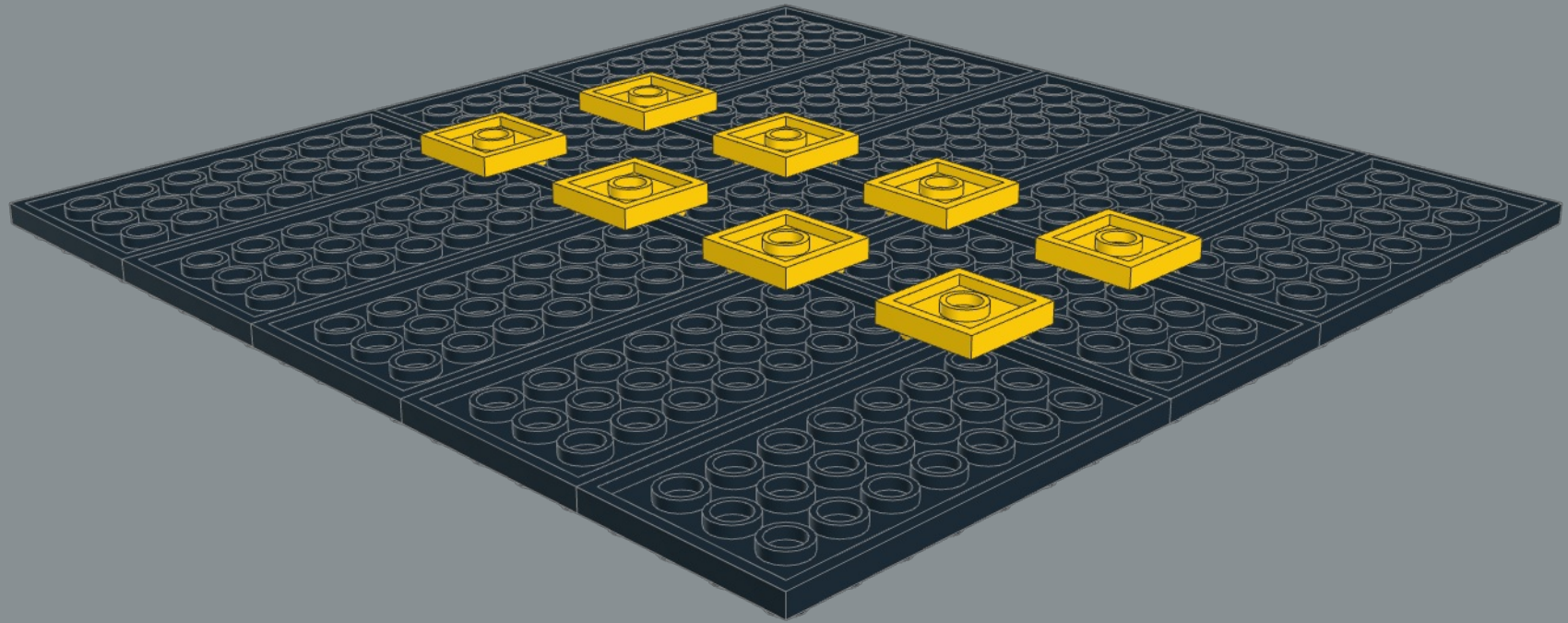
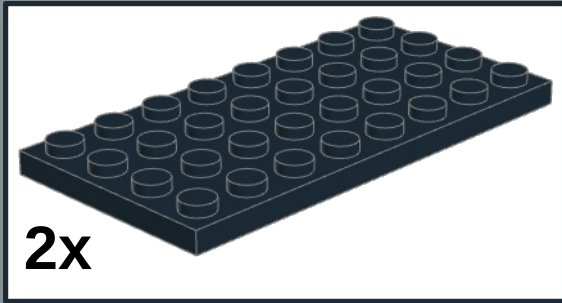

10

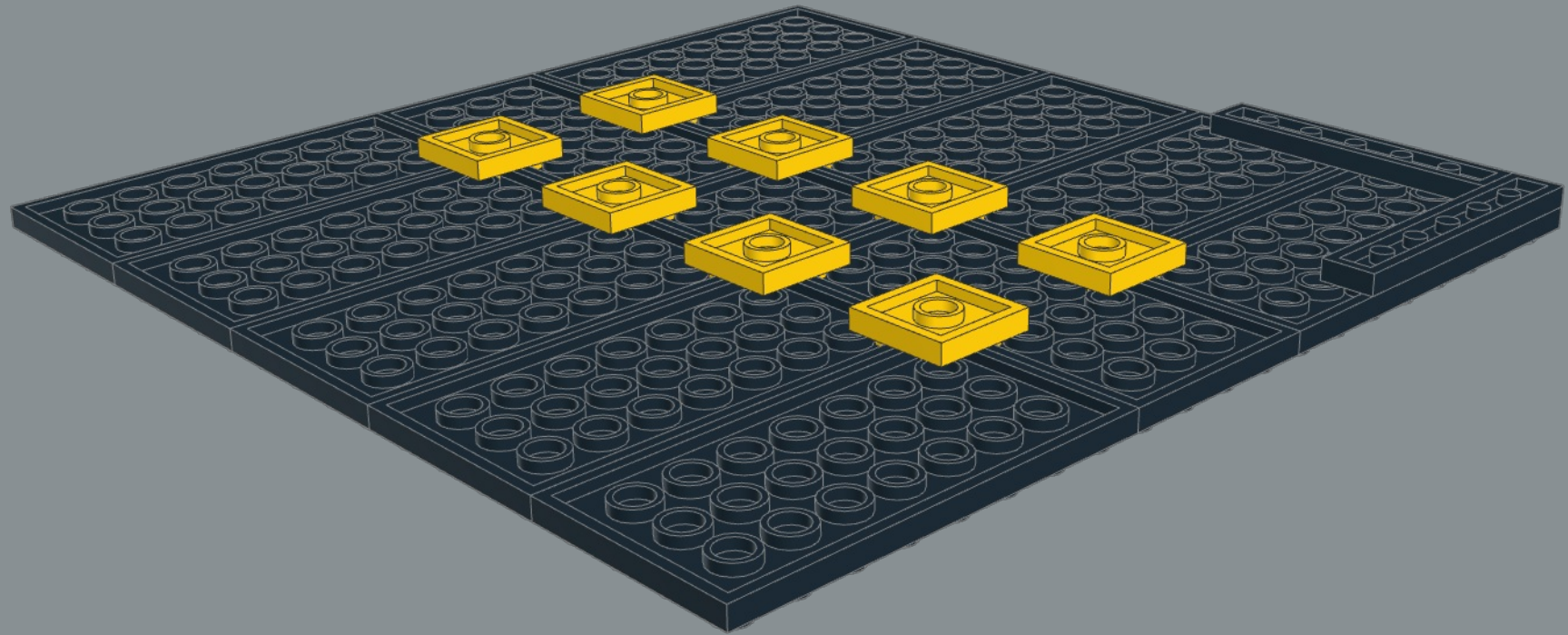
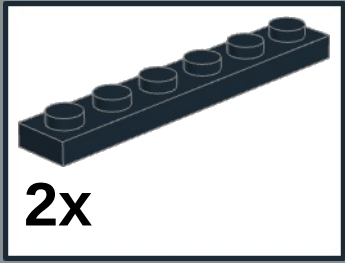

11

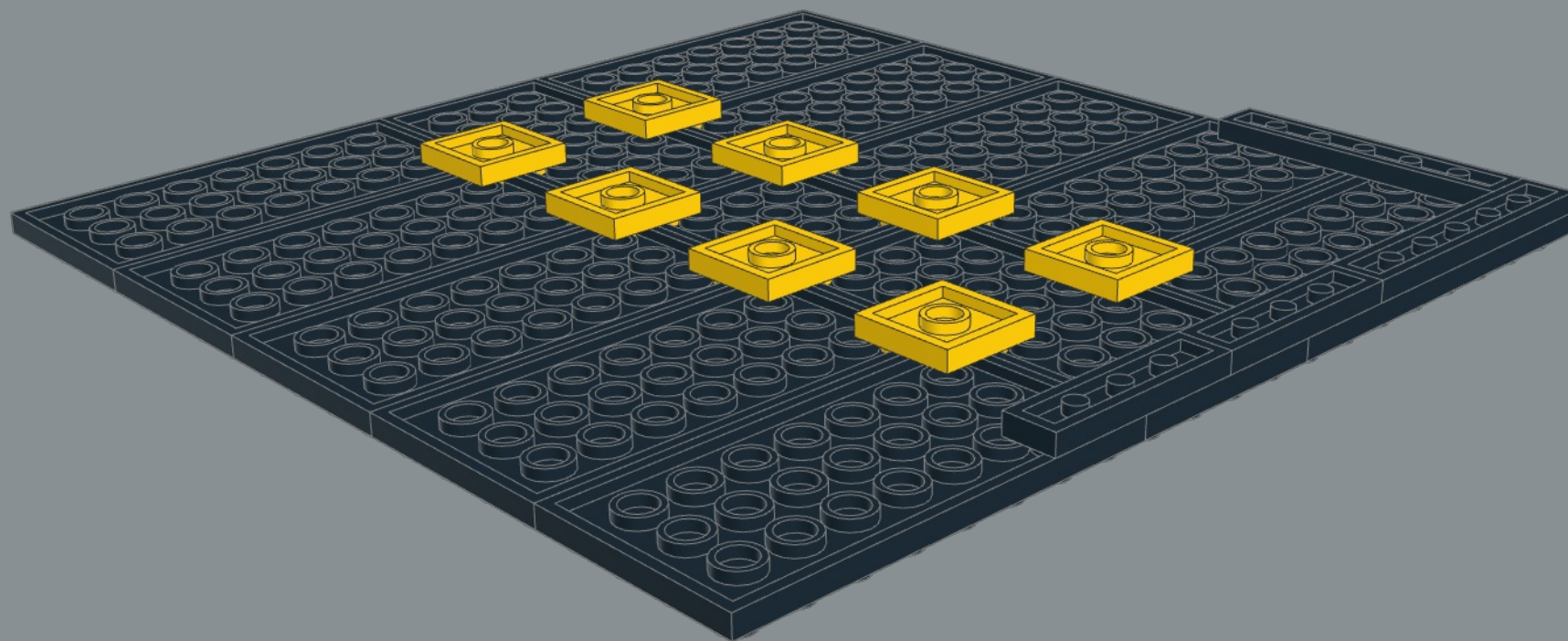
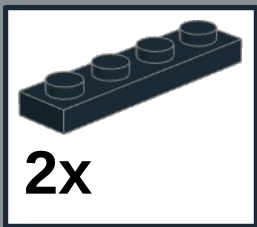

12

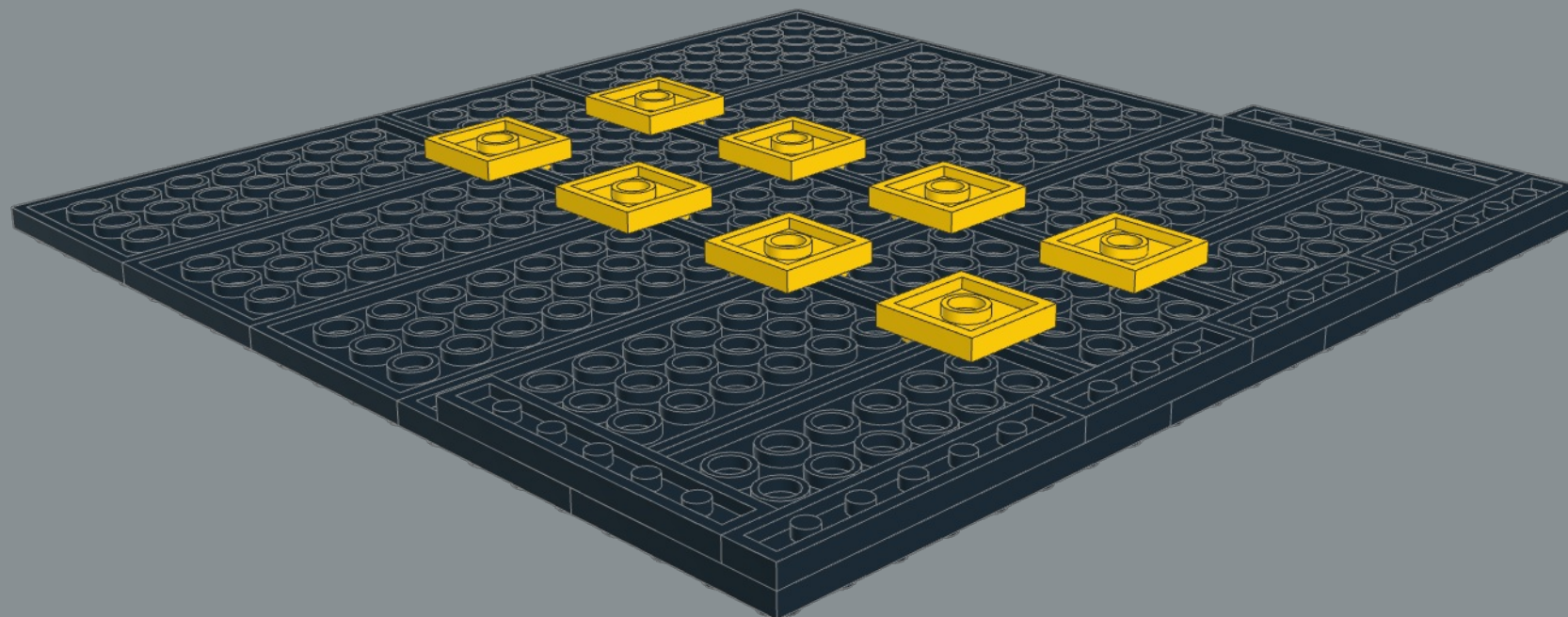
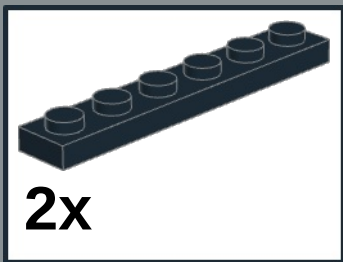

13

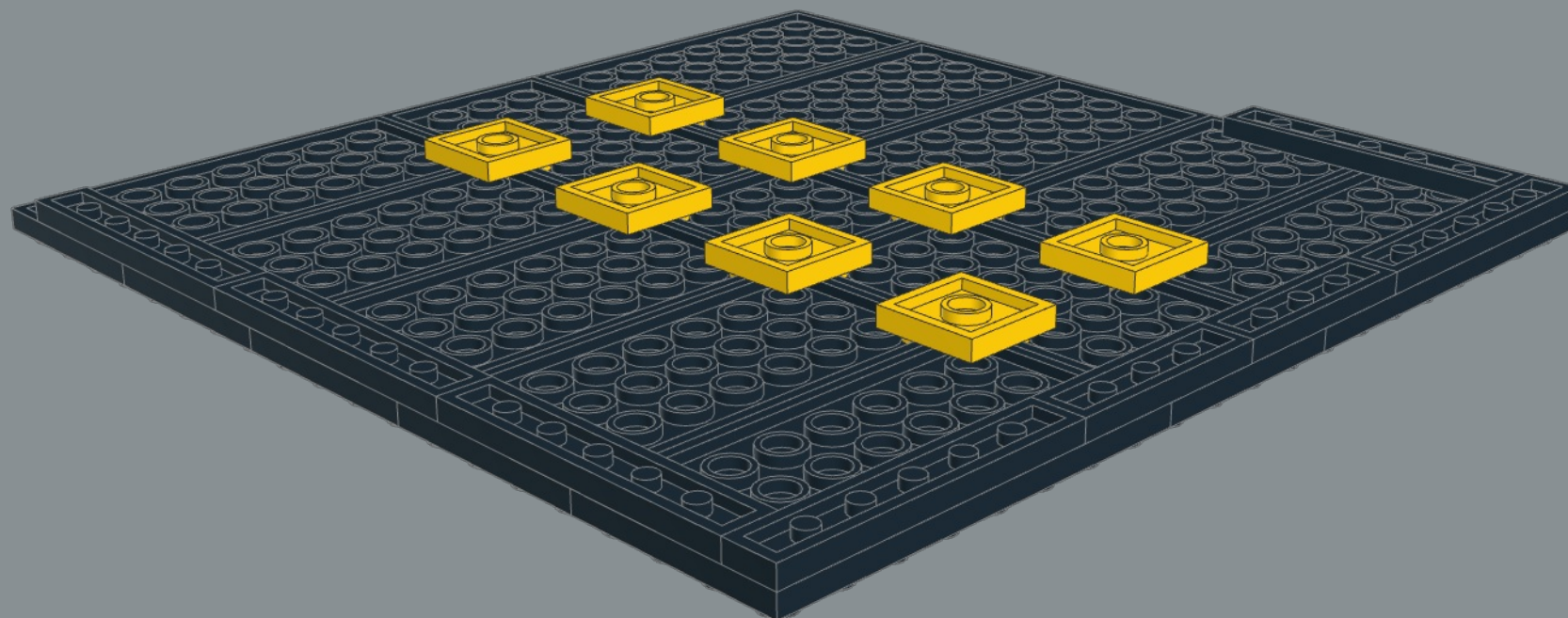
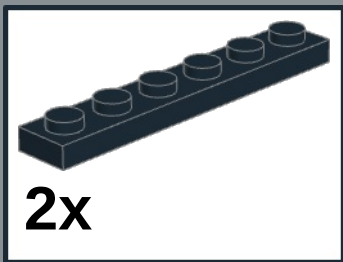

14

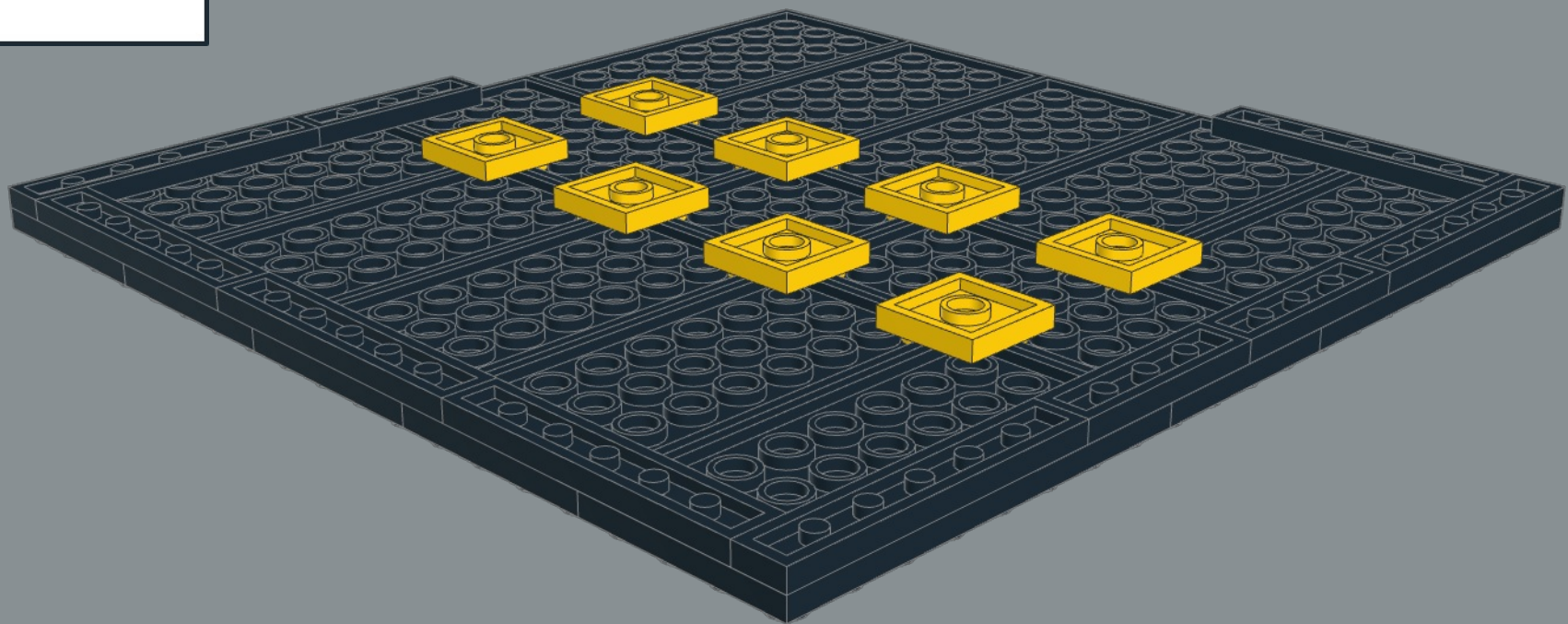
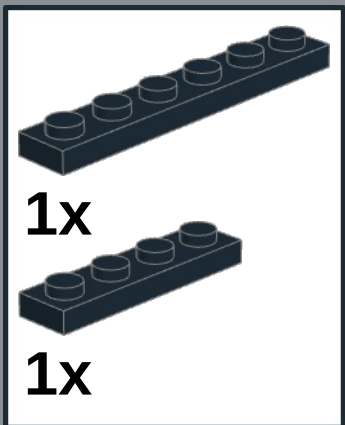

15

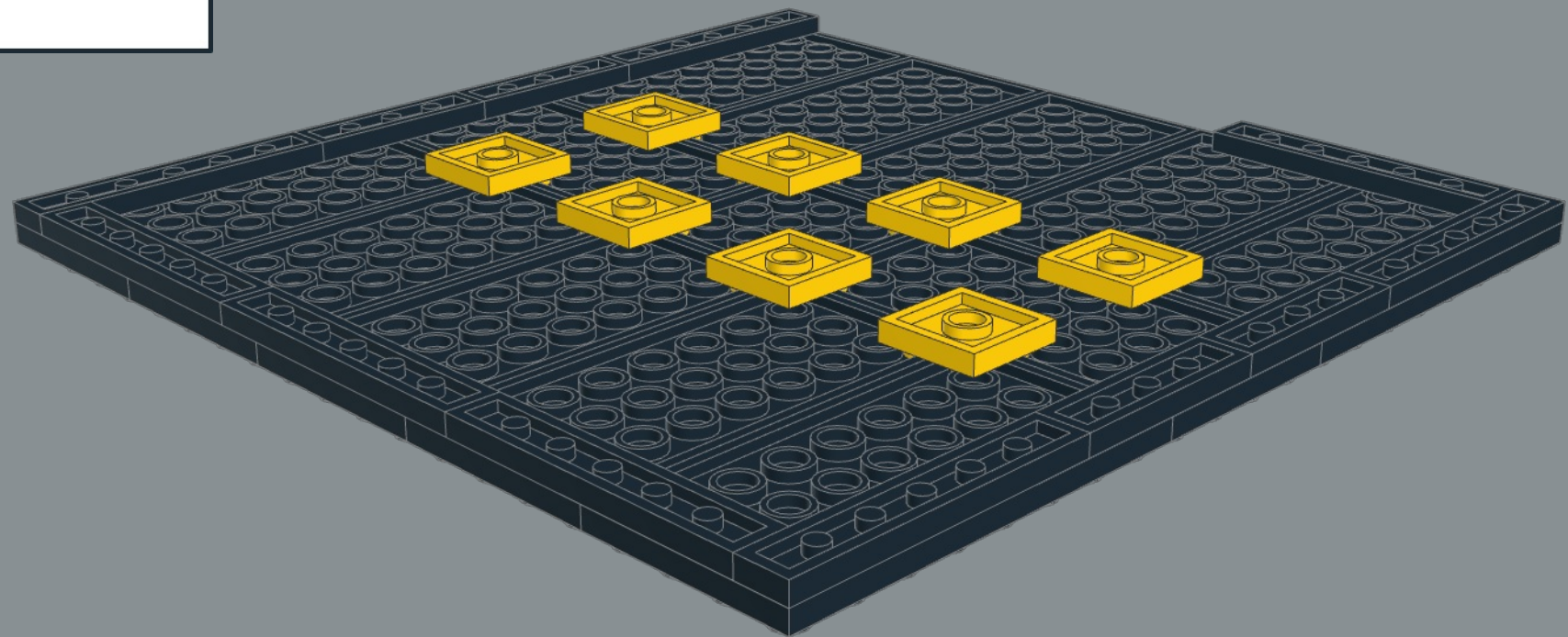
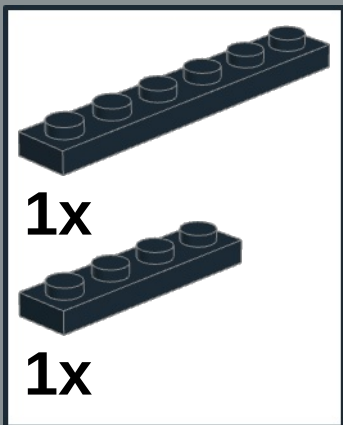

16

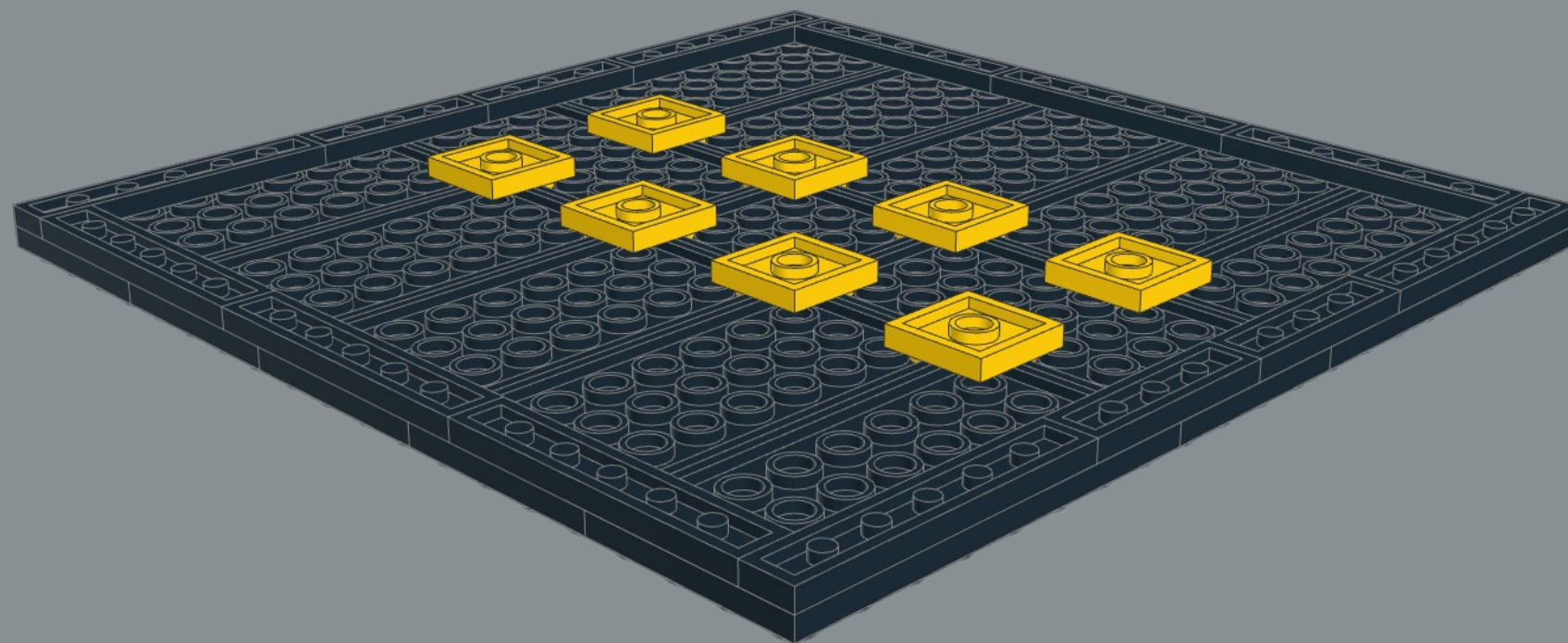
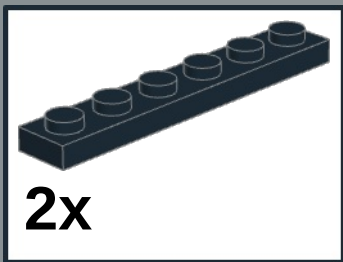

17

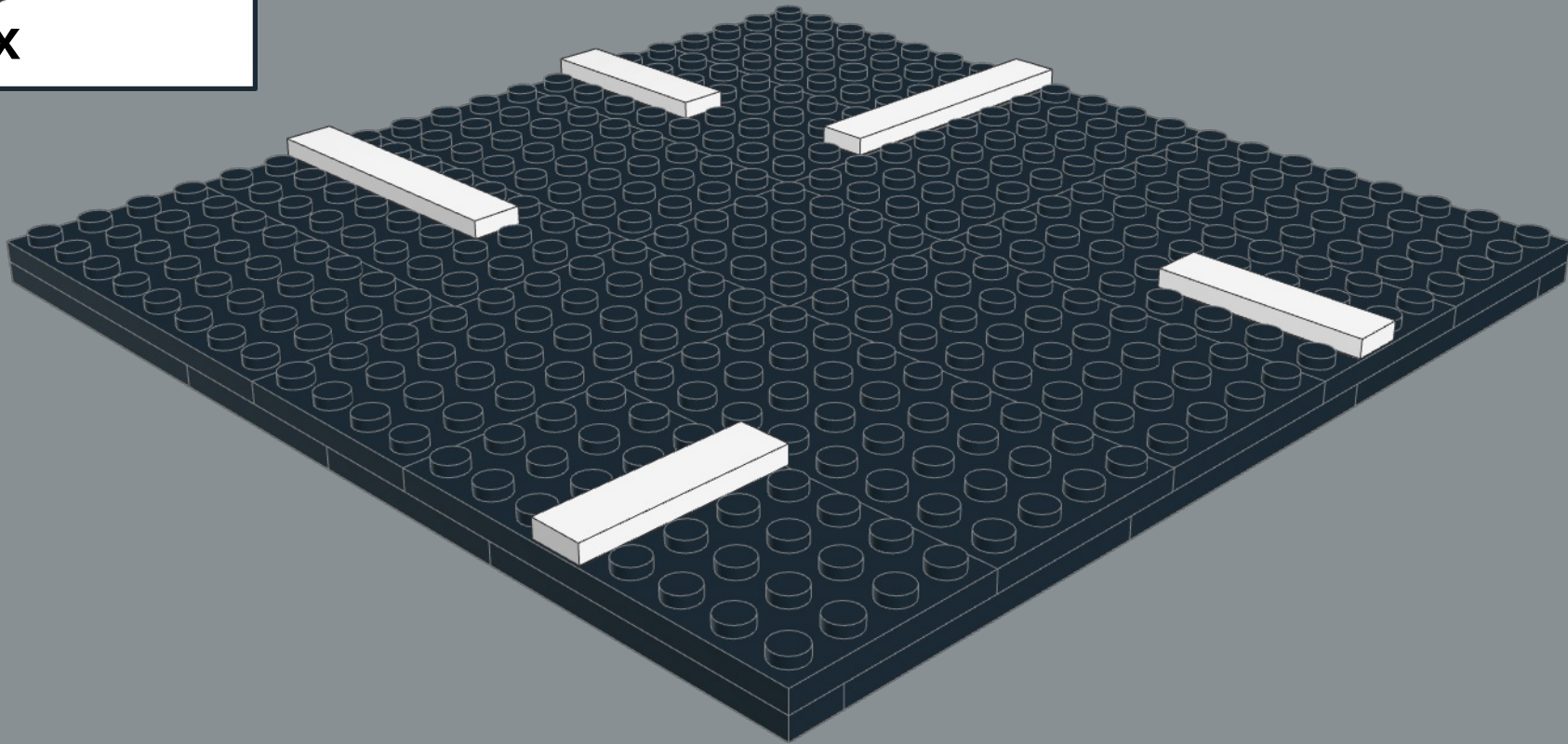
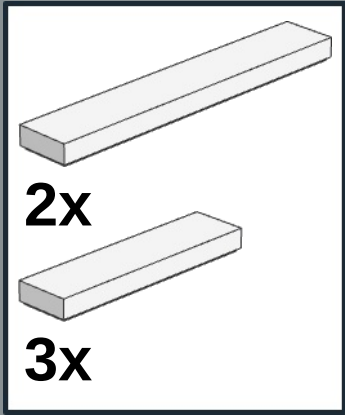

18

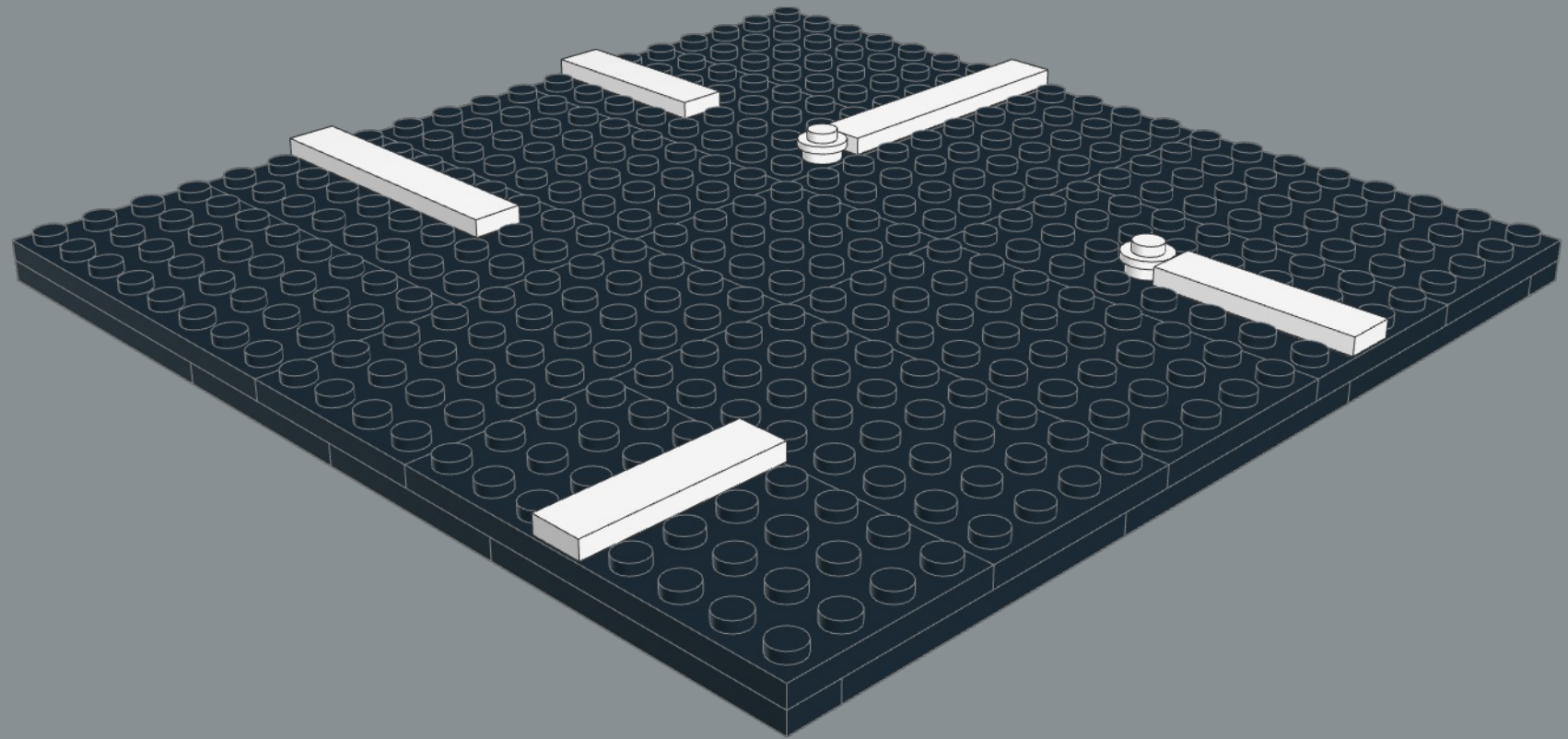

19

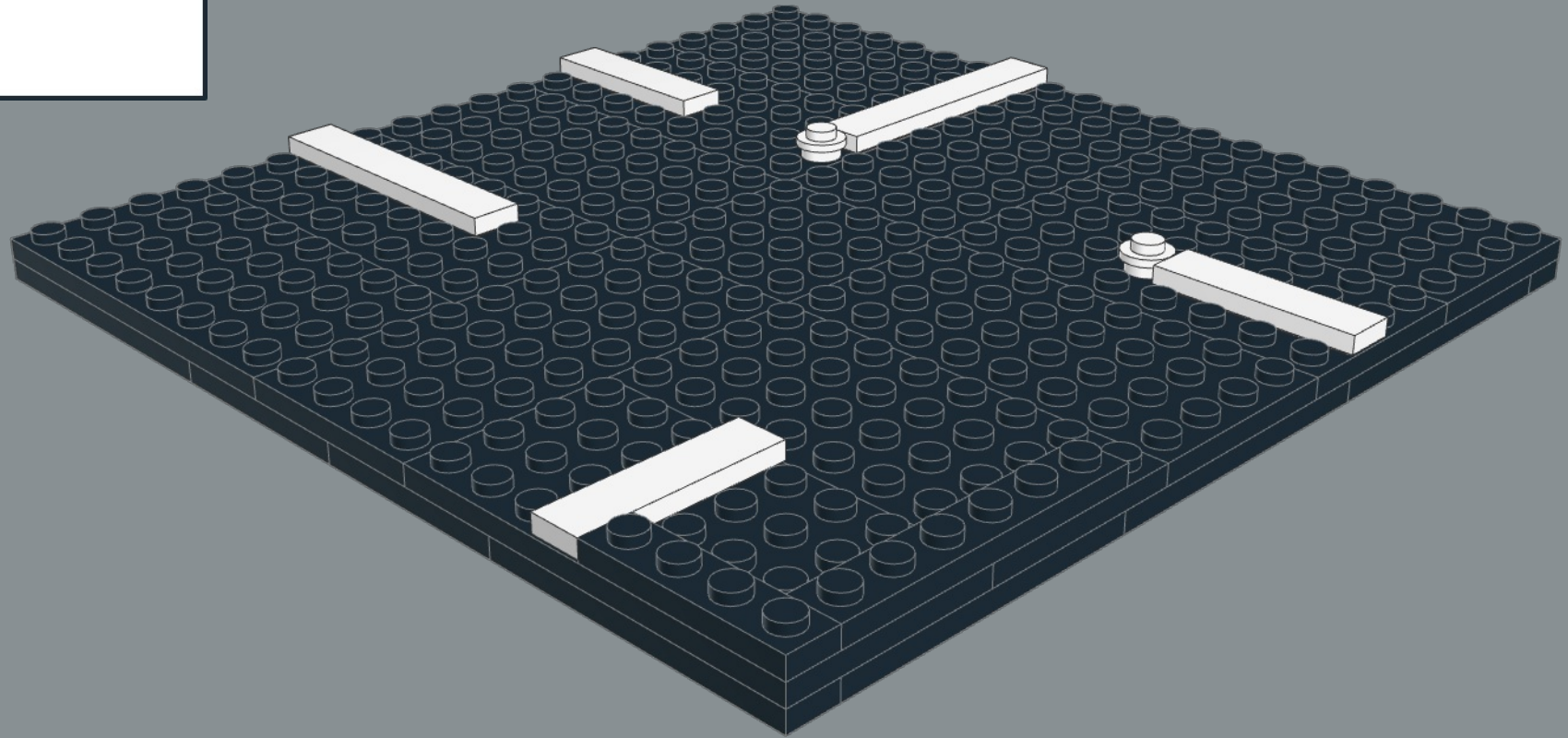
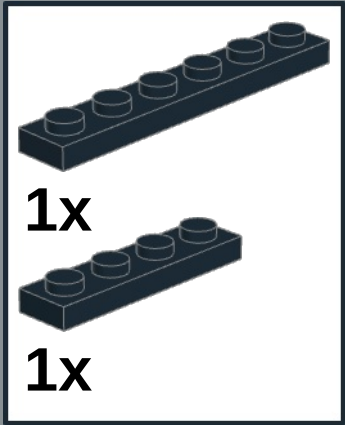

20

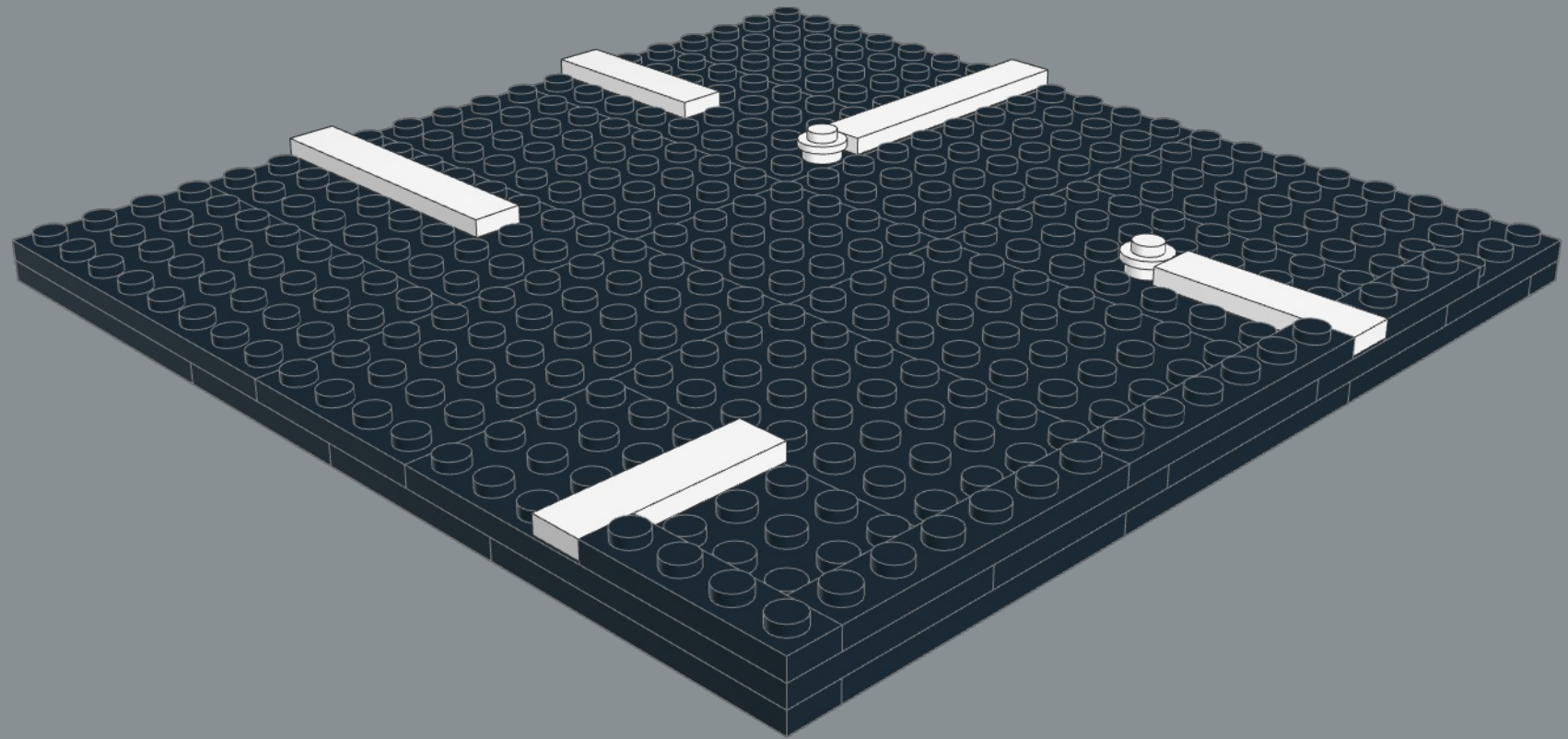
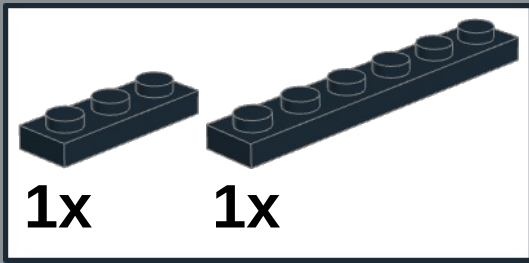

21

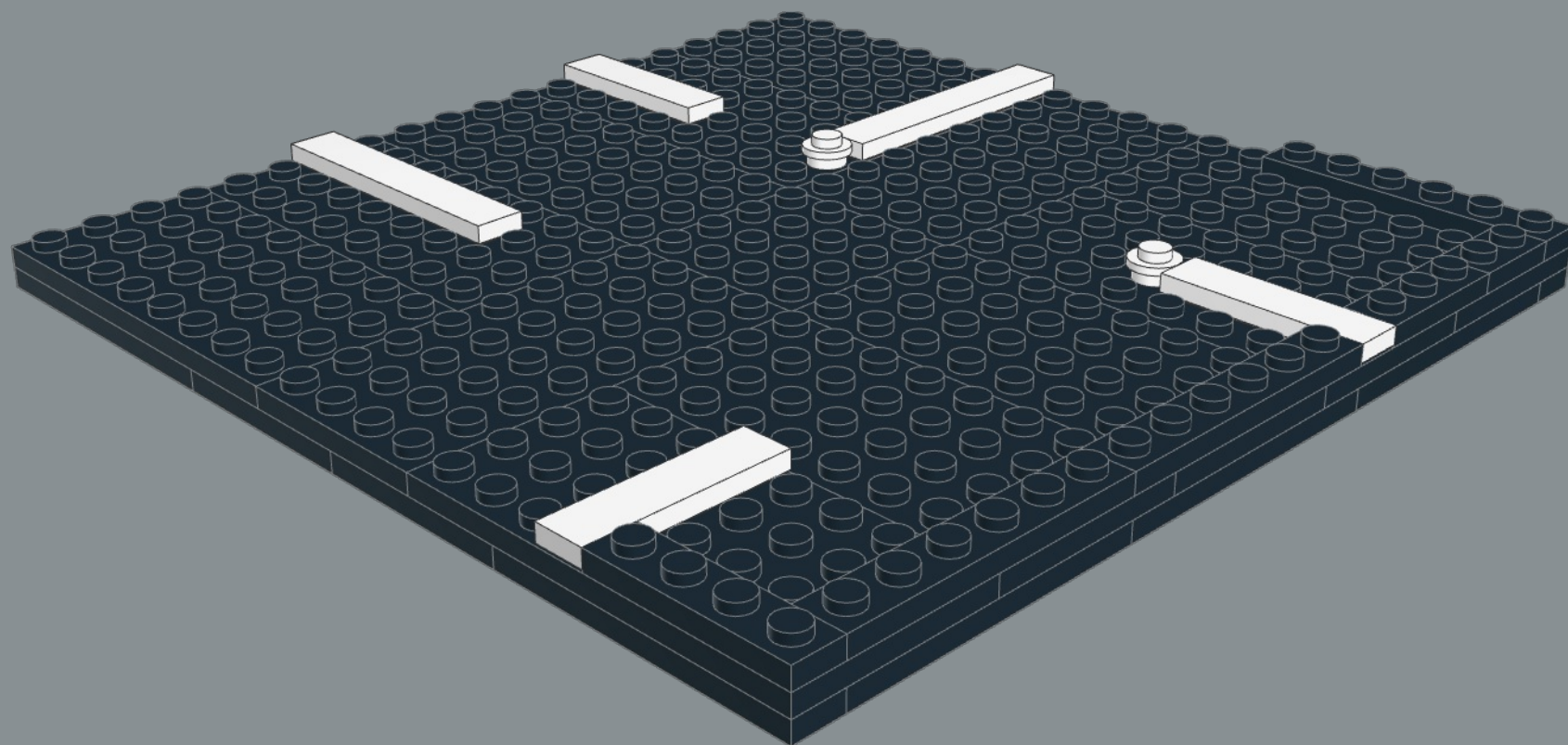
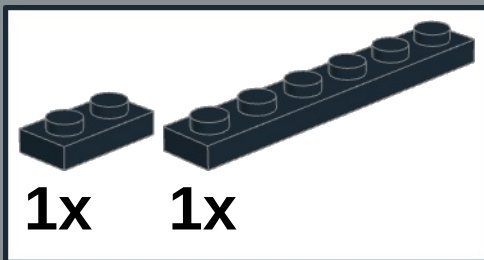

22

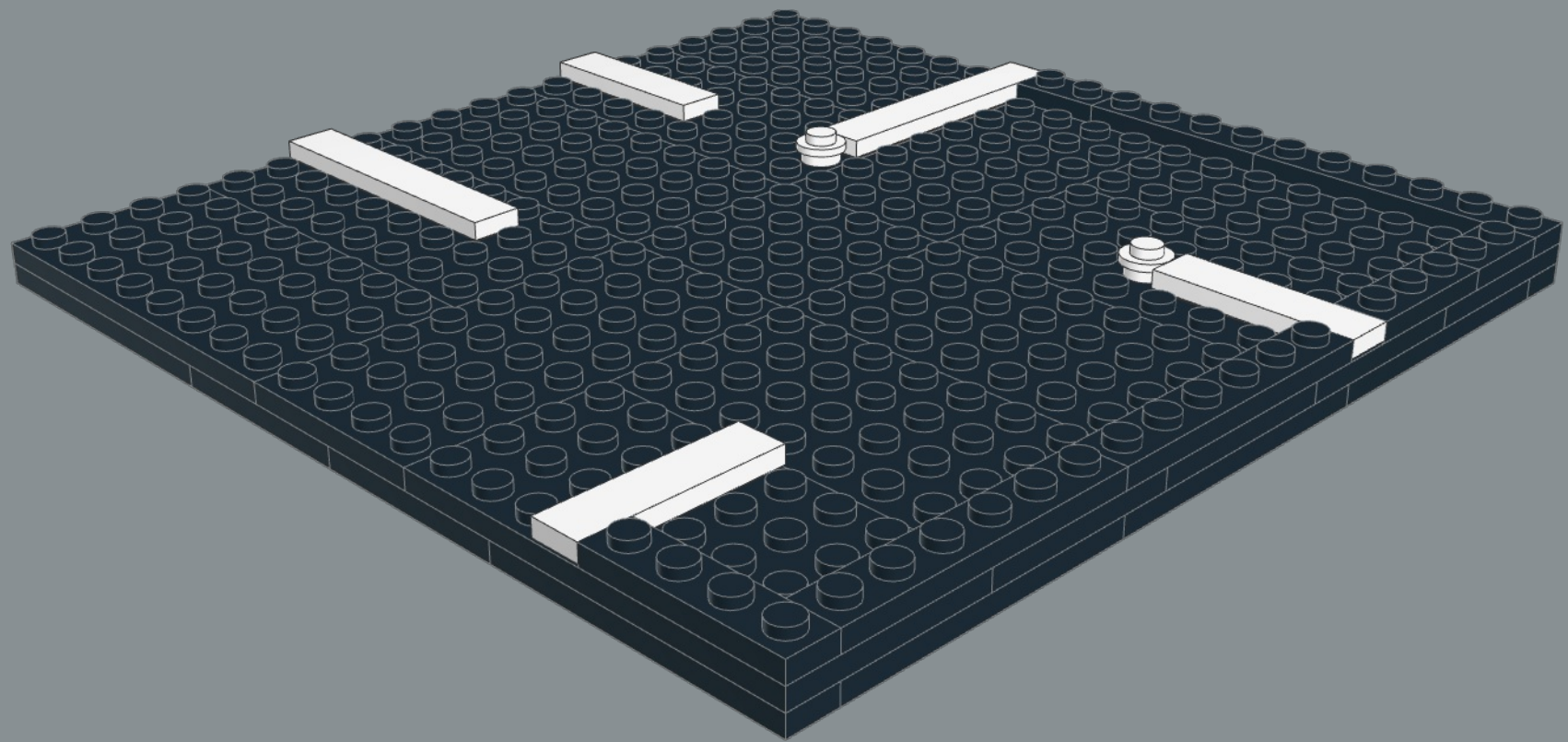
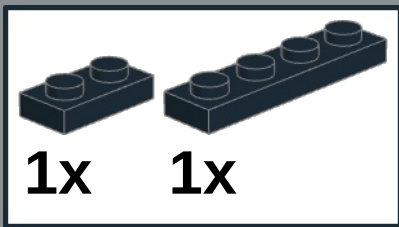

23

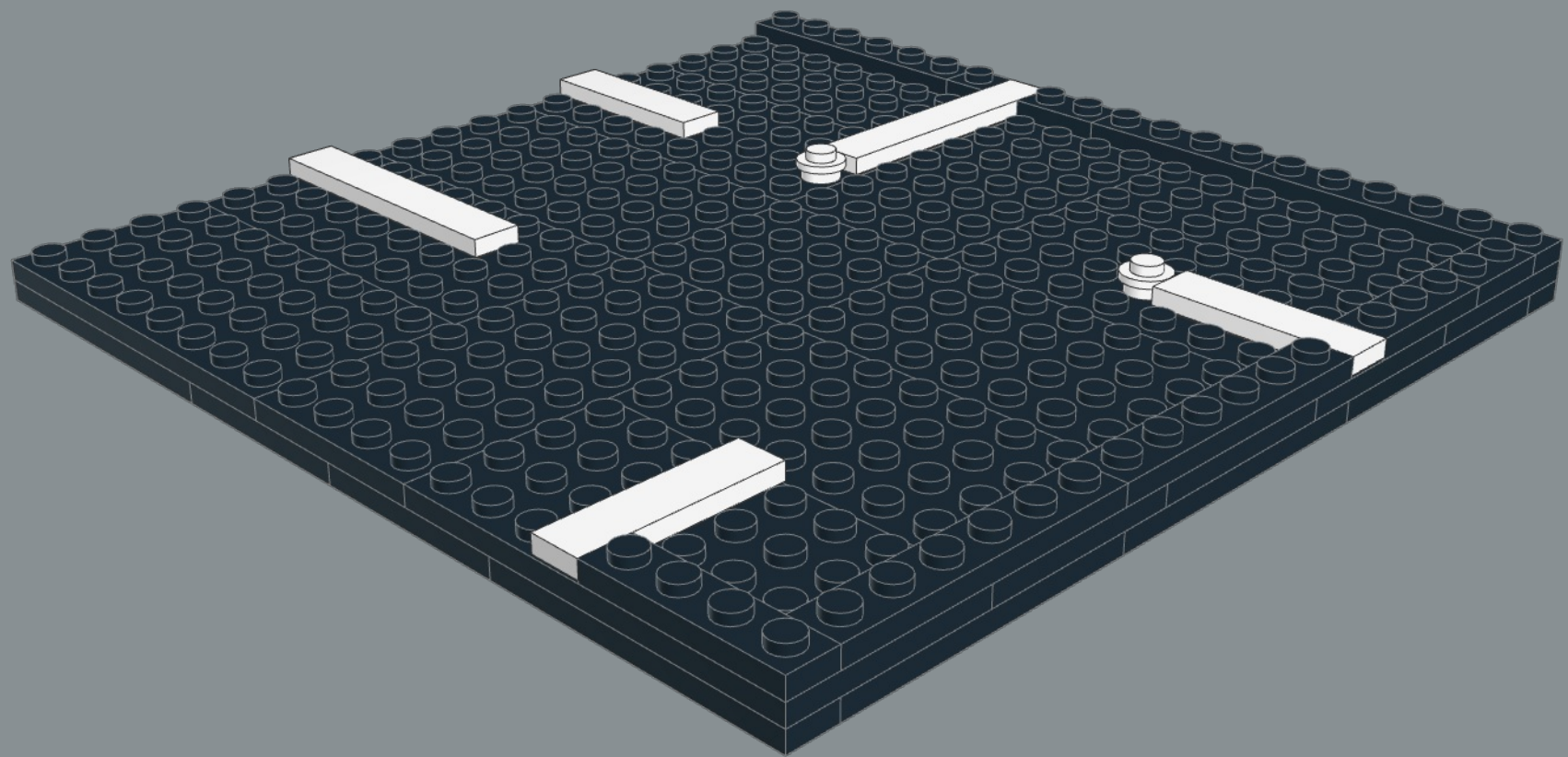
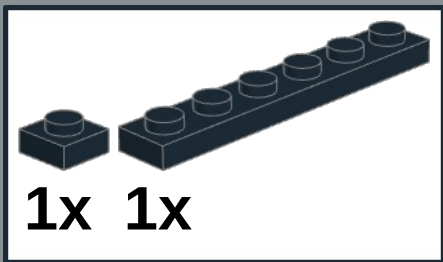

24

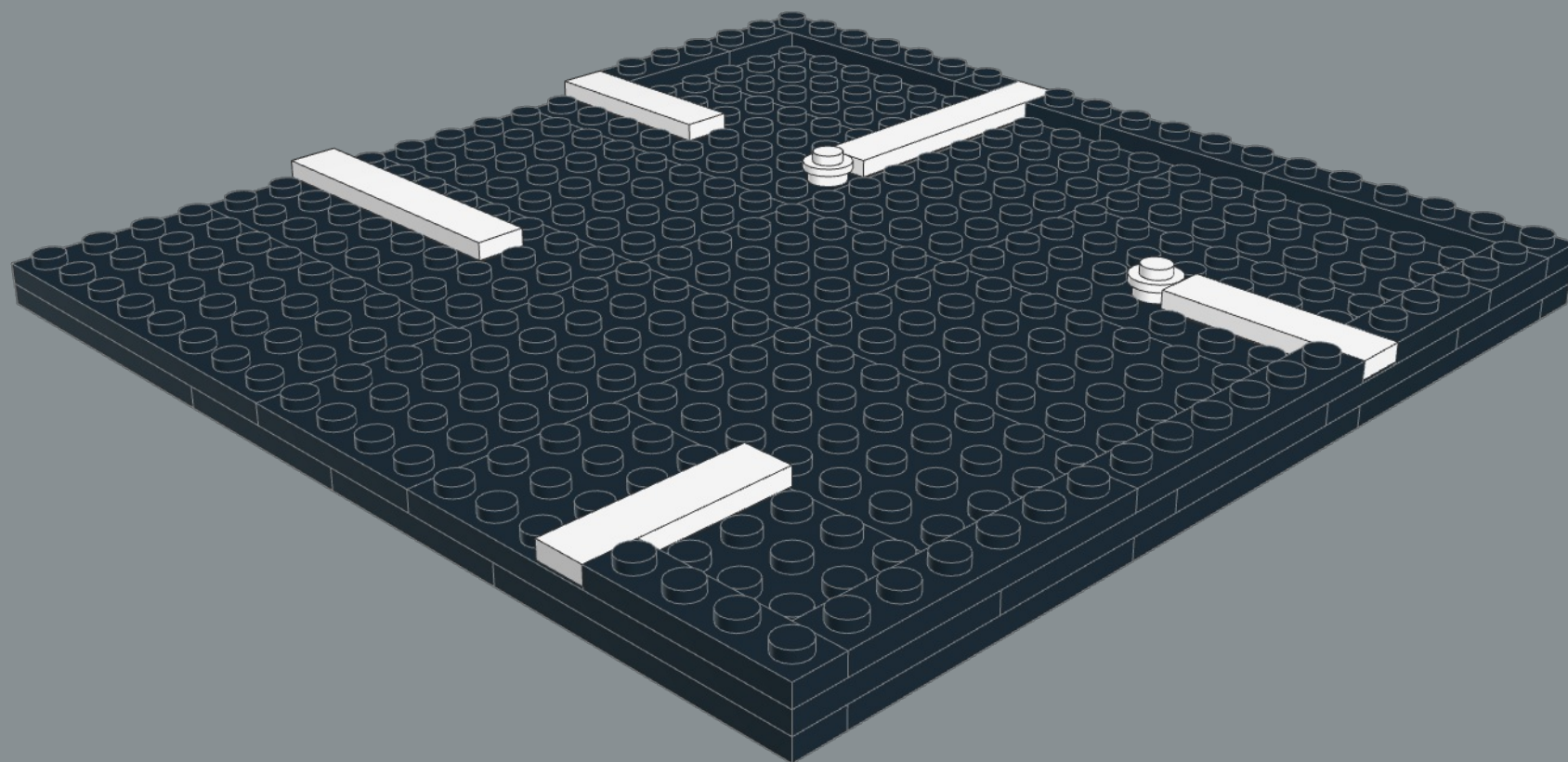
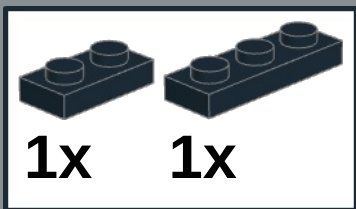

25

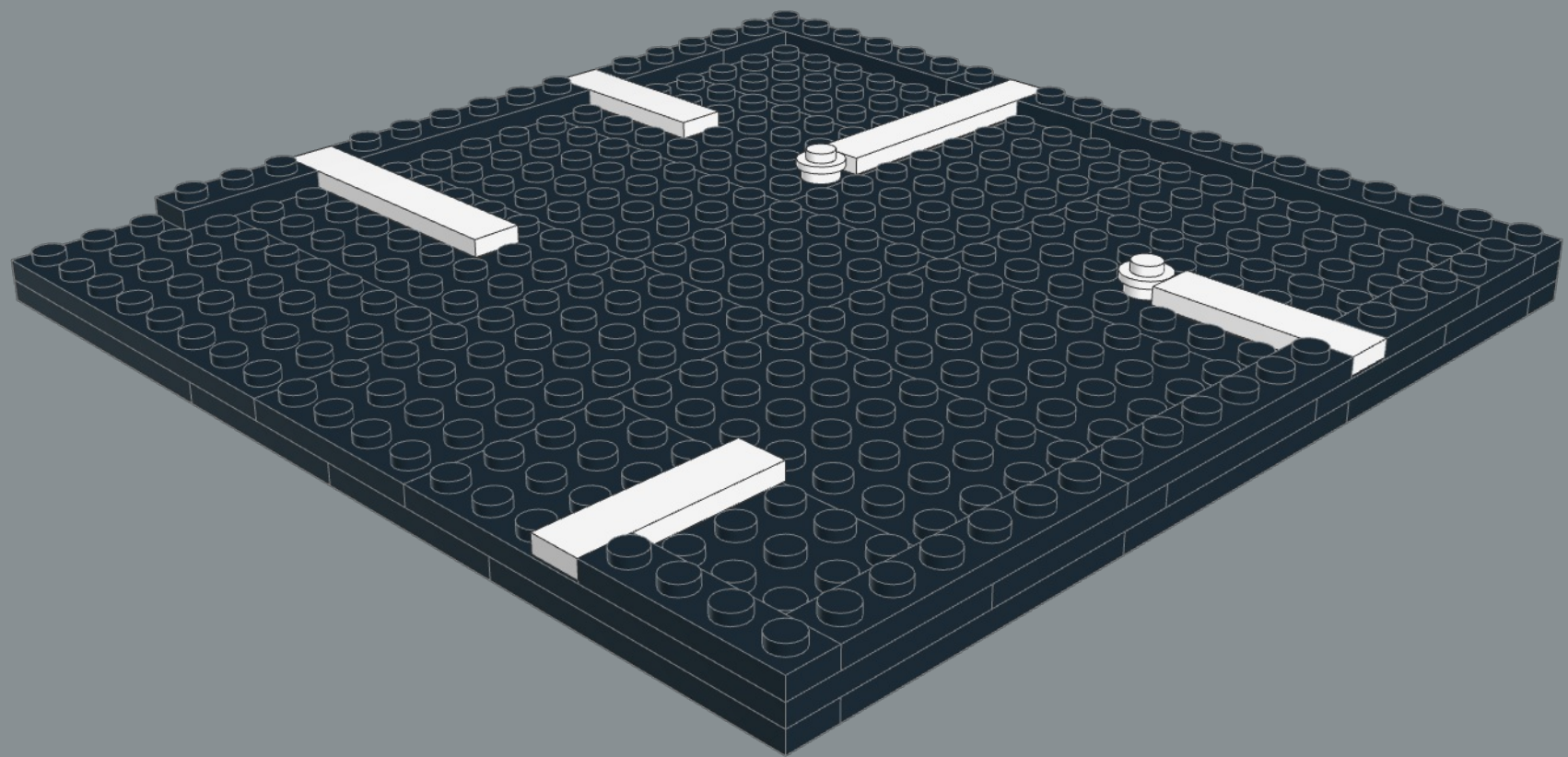
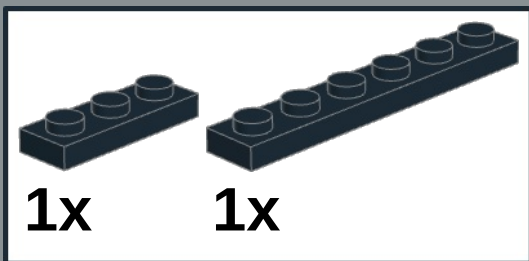

26

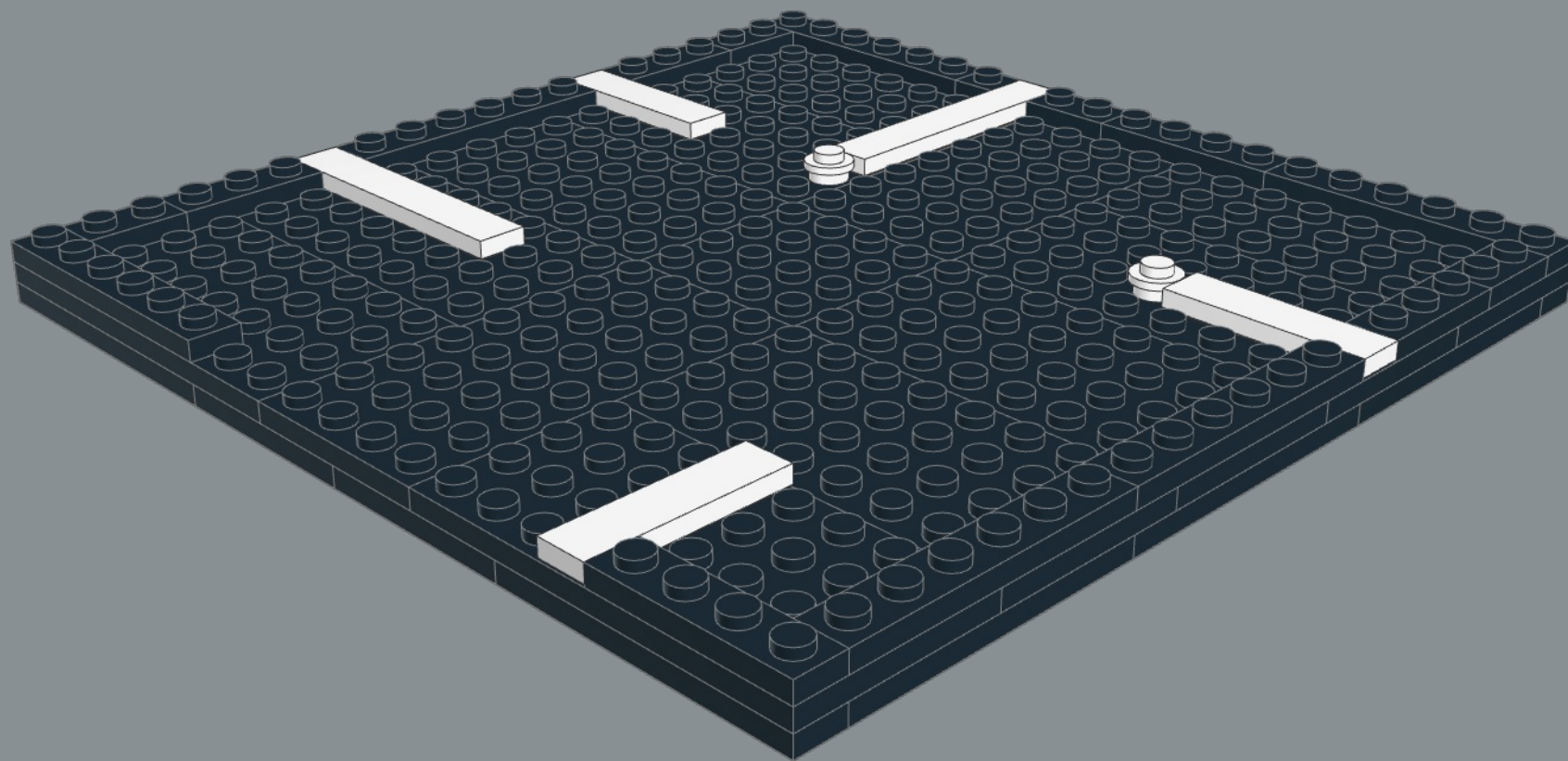
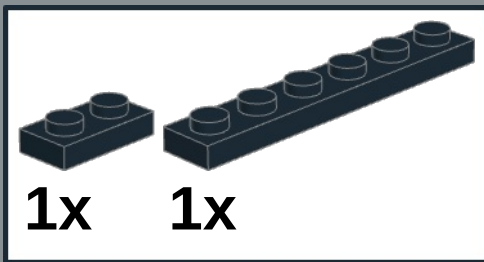

27

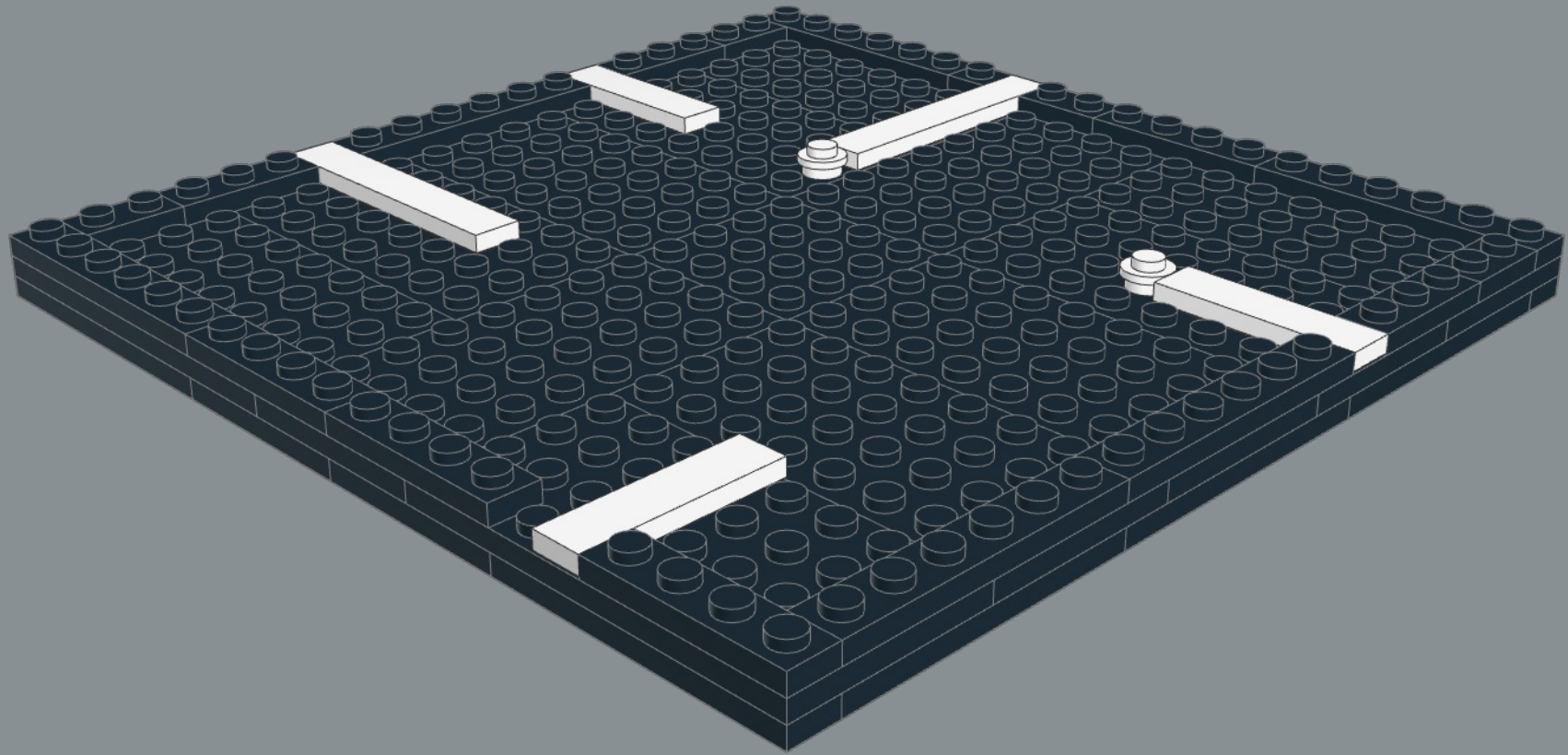
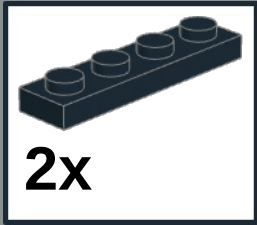

28

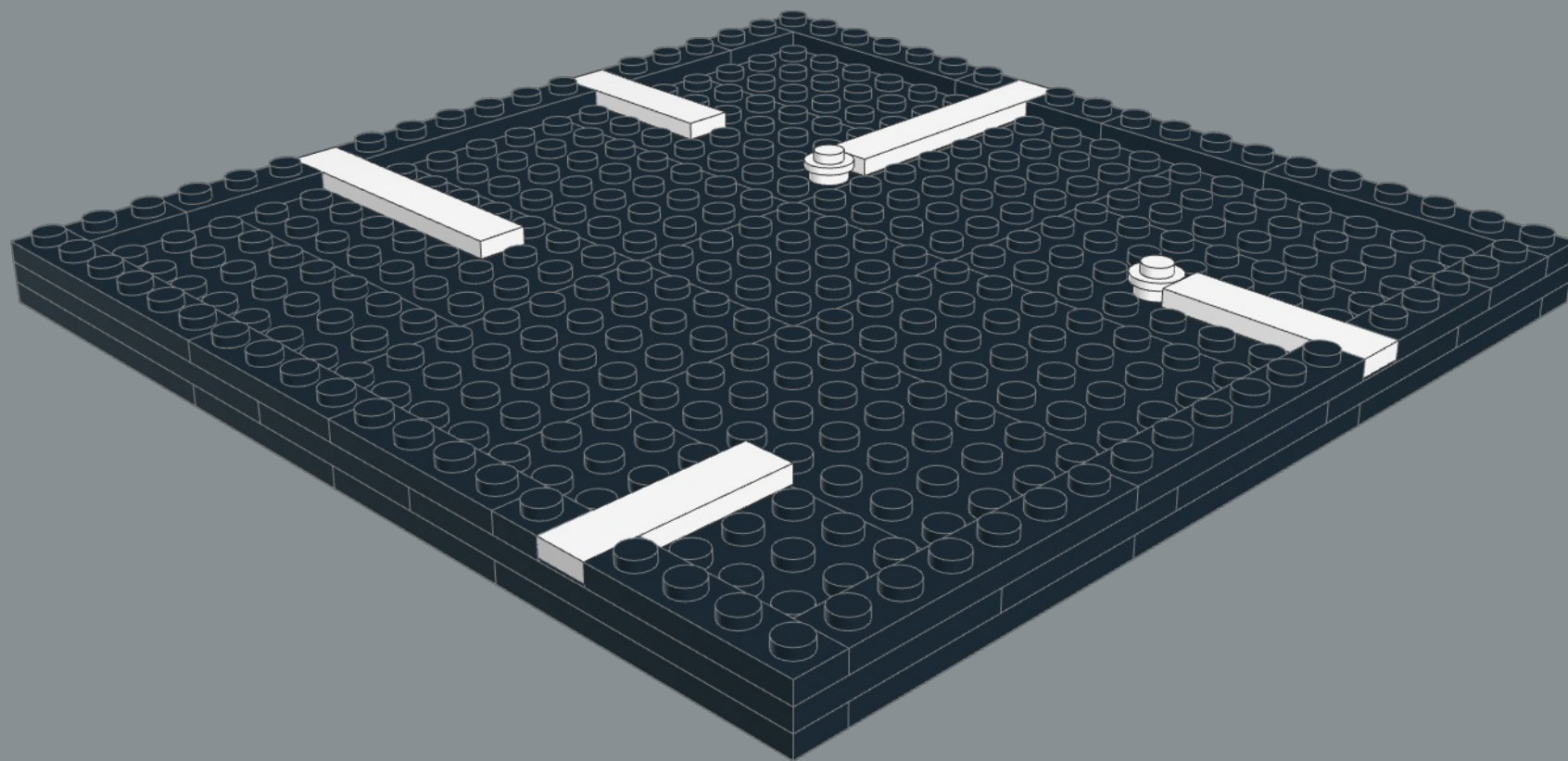
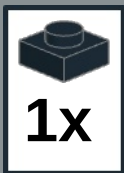

29

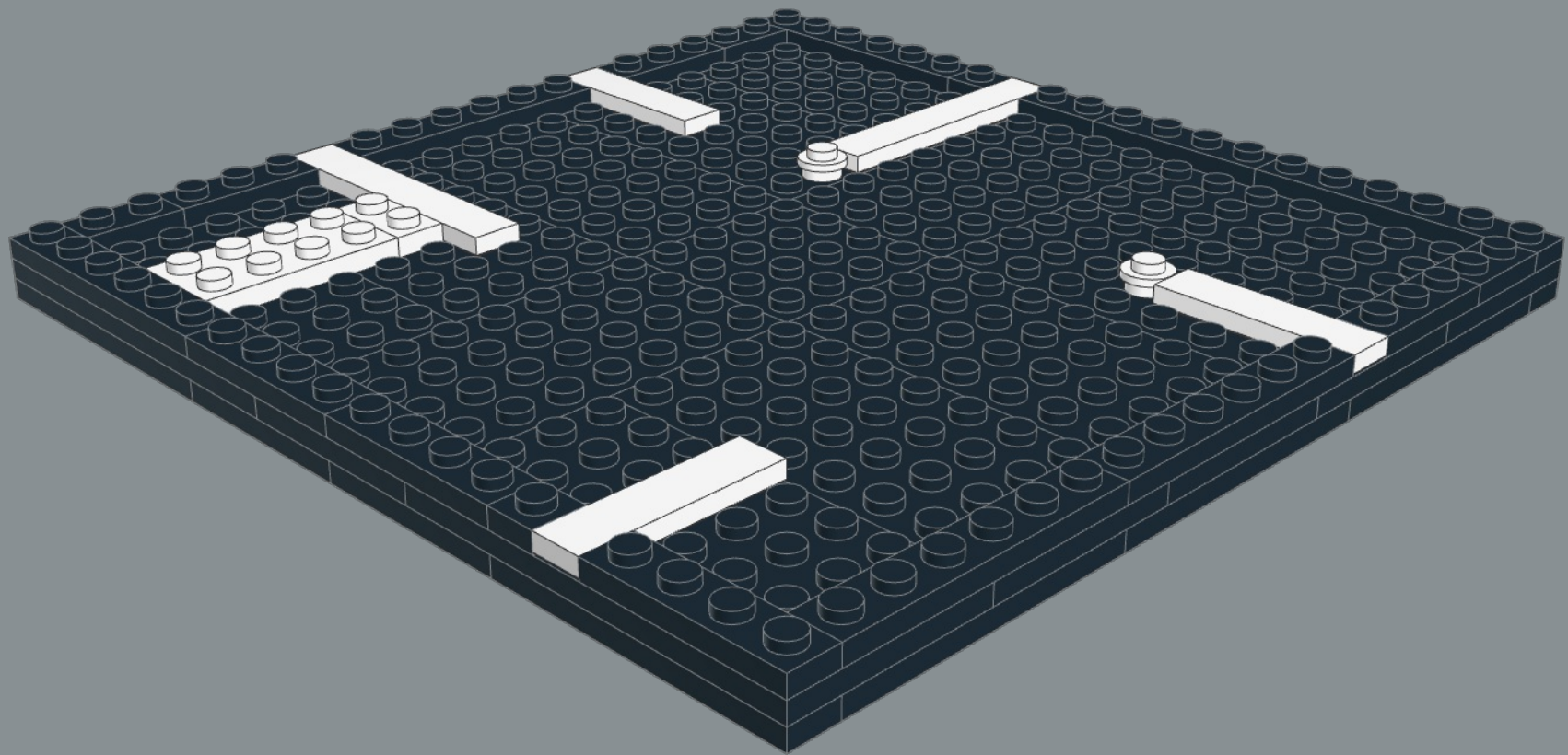
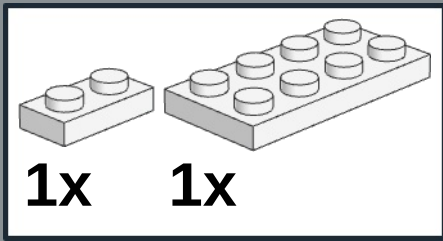

30

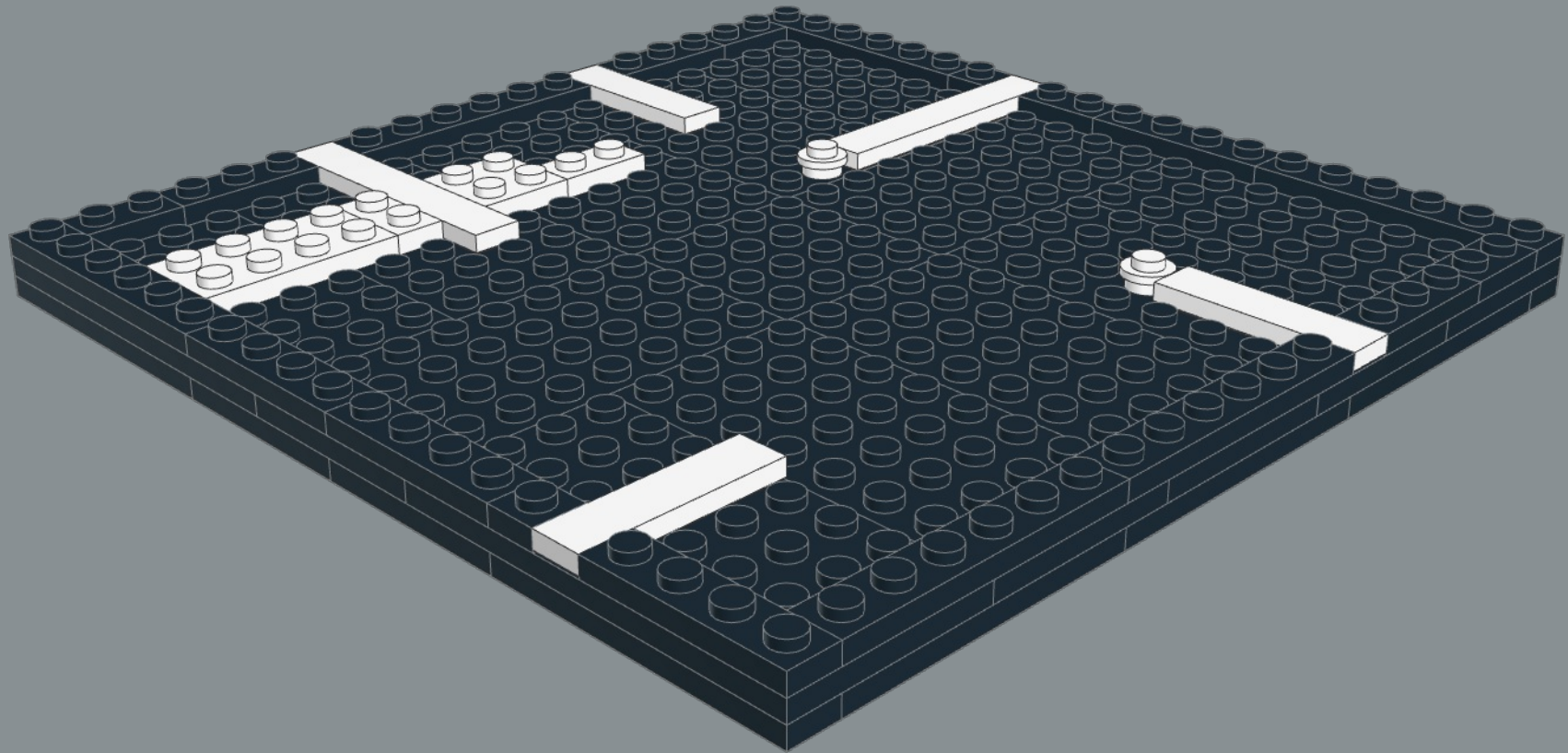
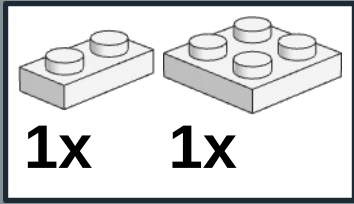

31

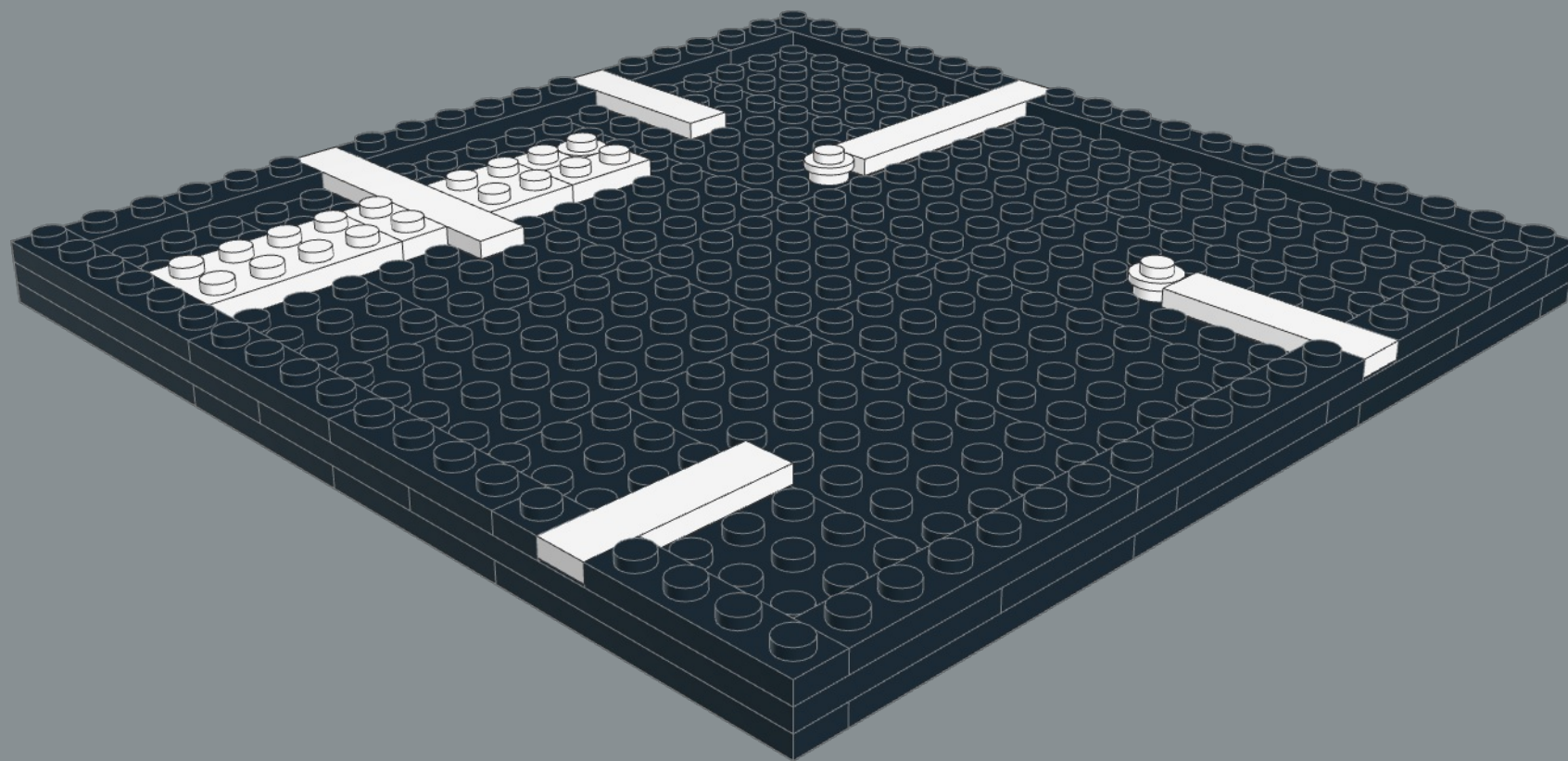
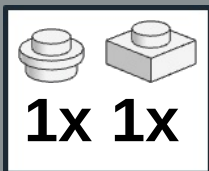

32

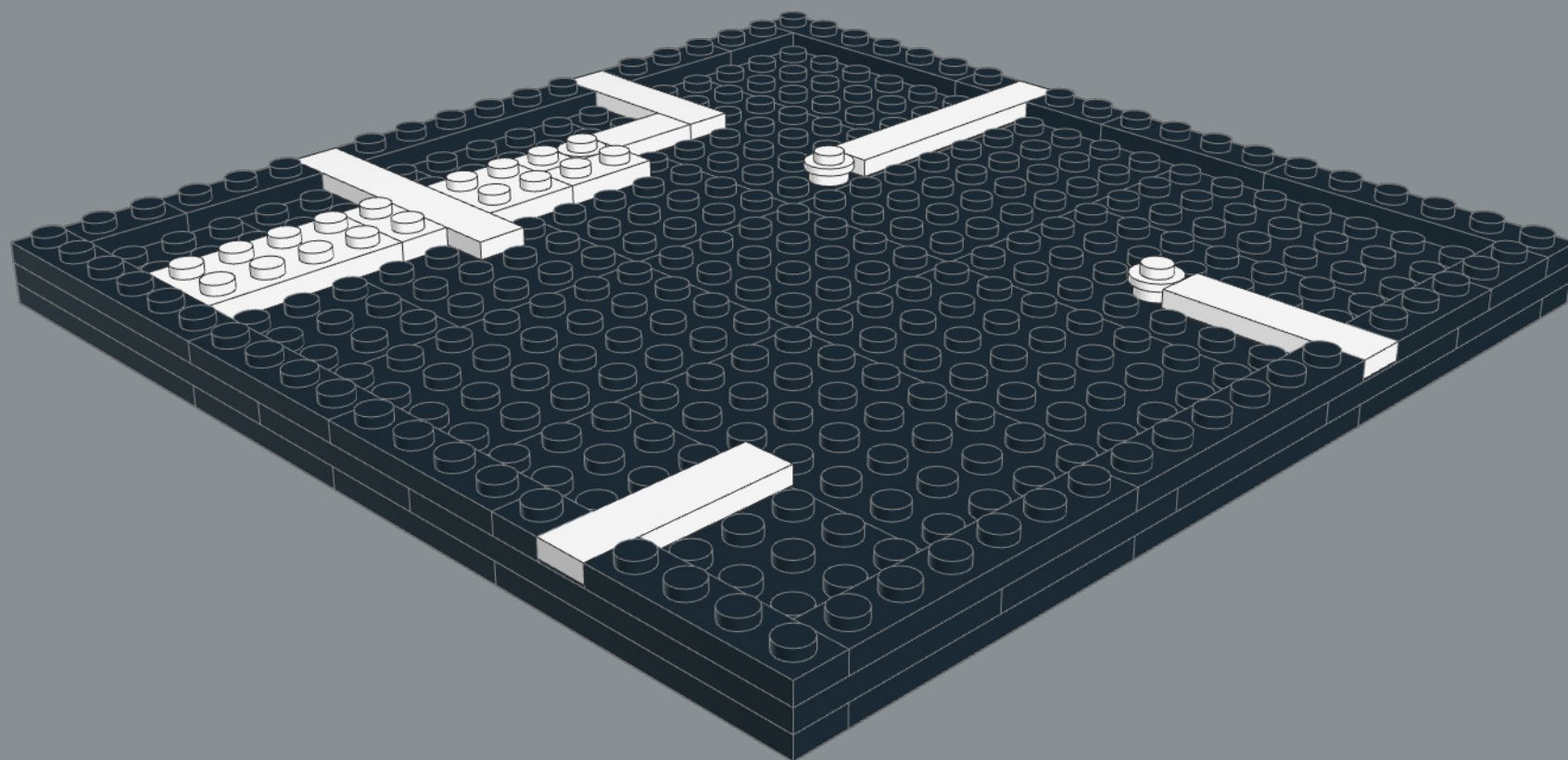
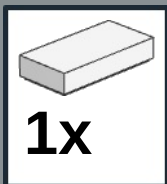

33

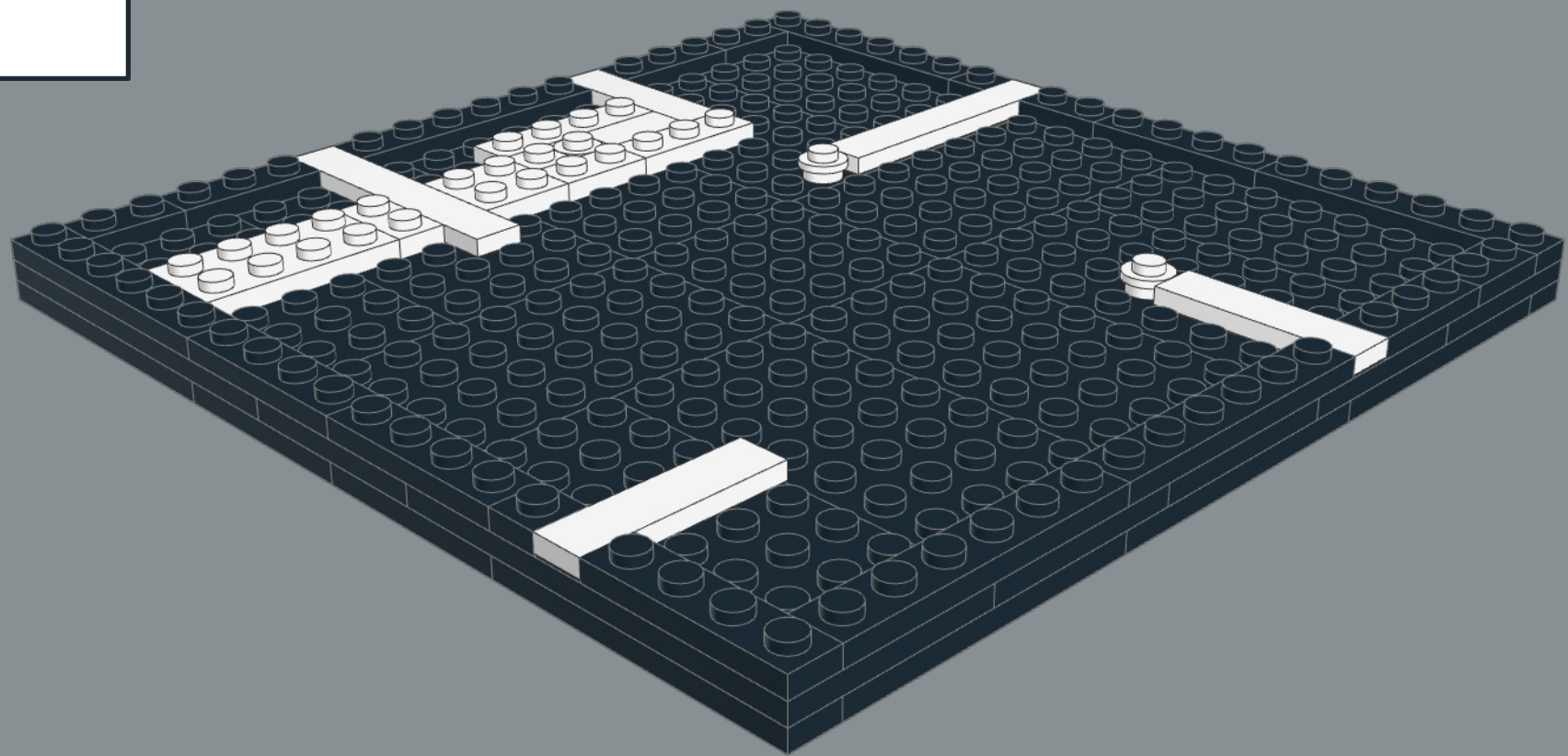
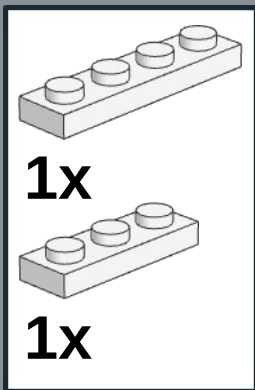

34

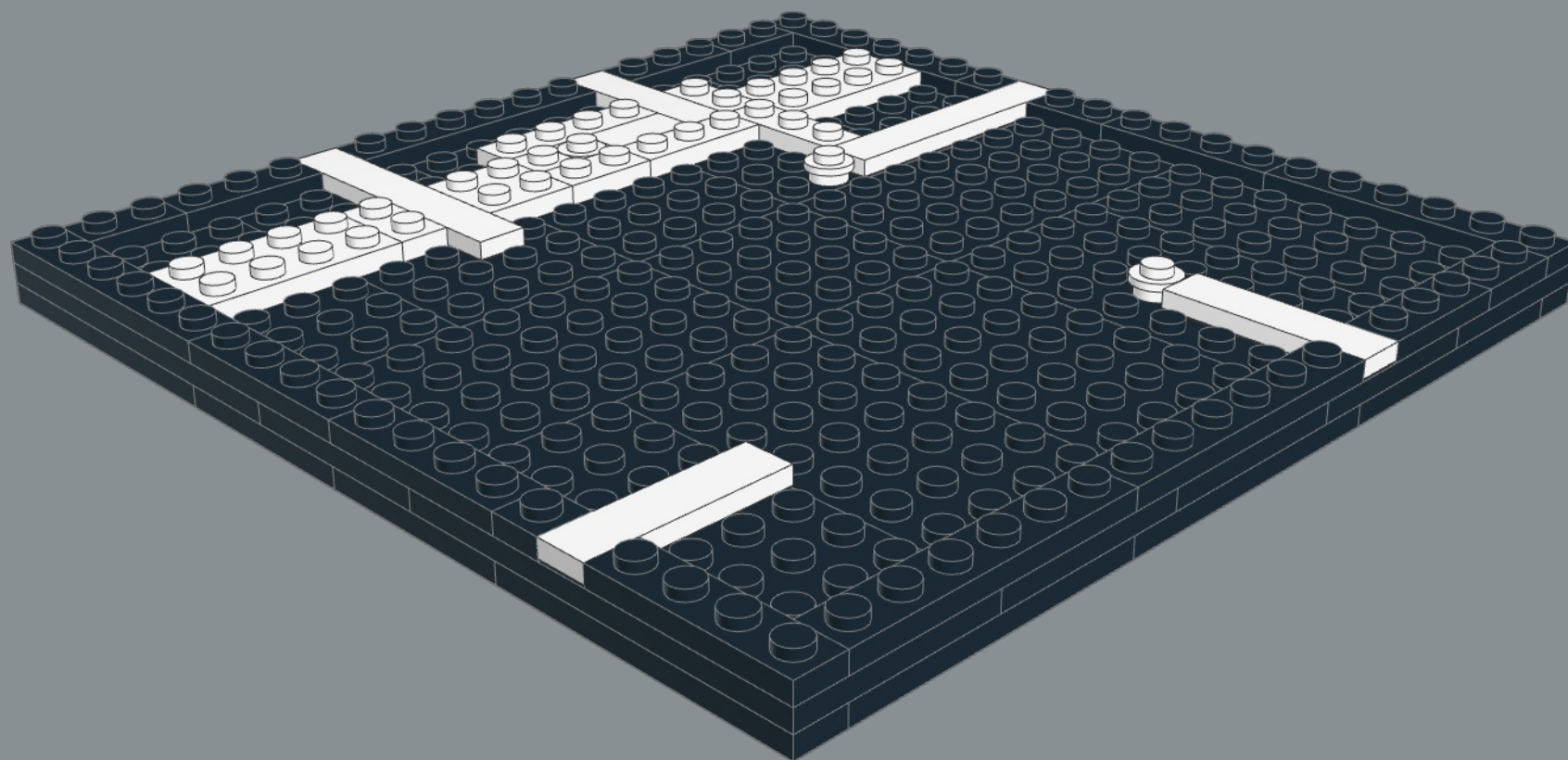
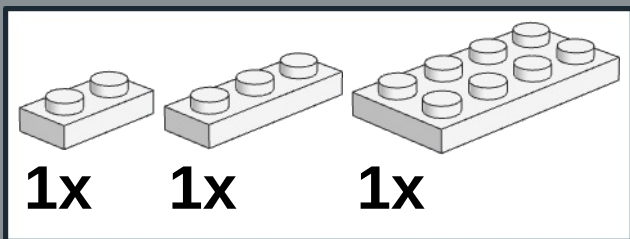

35

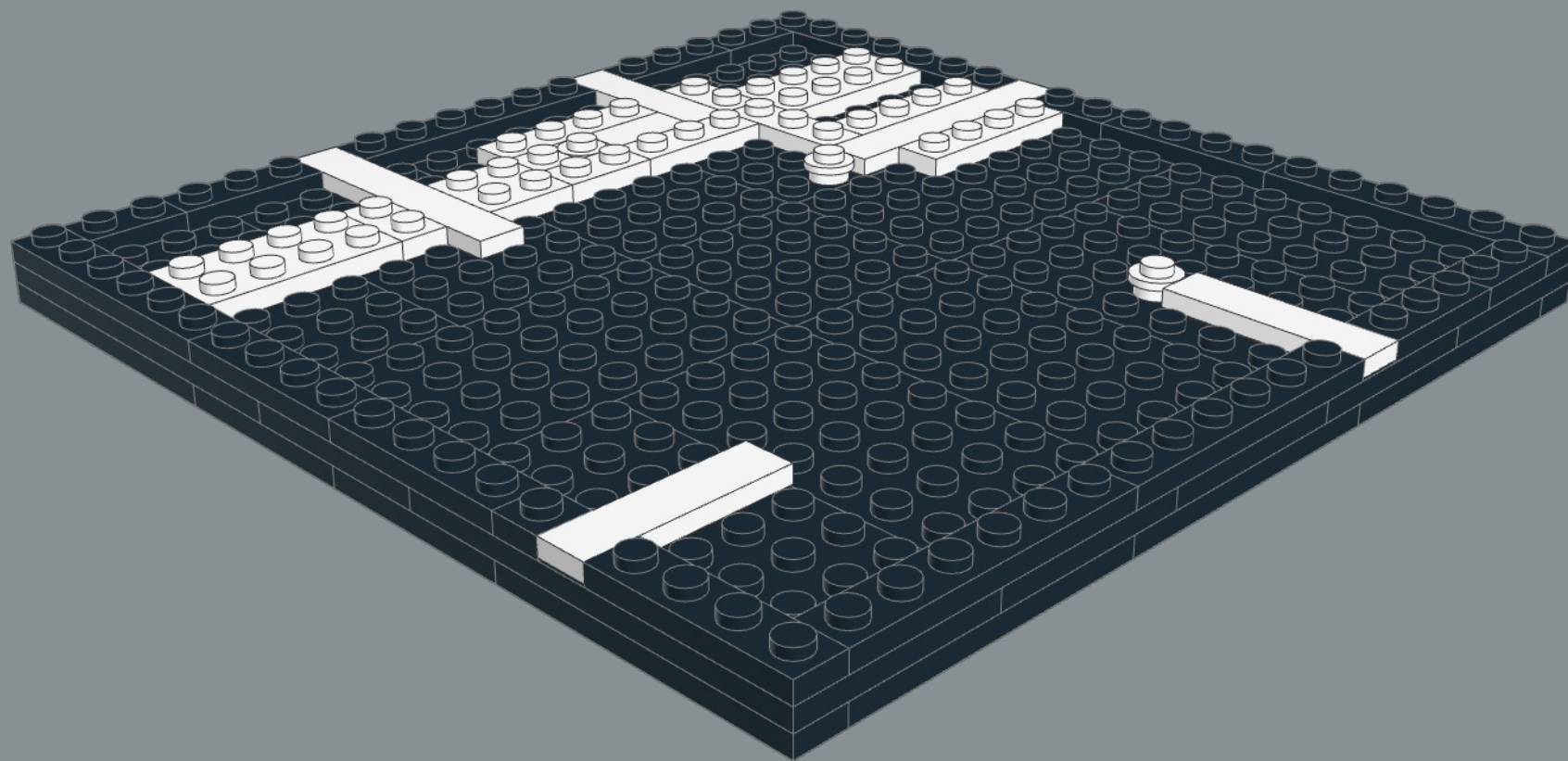
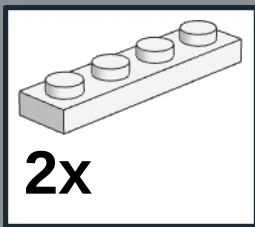

36

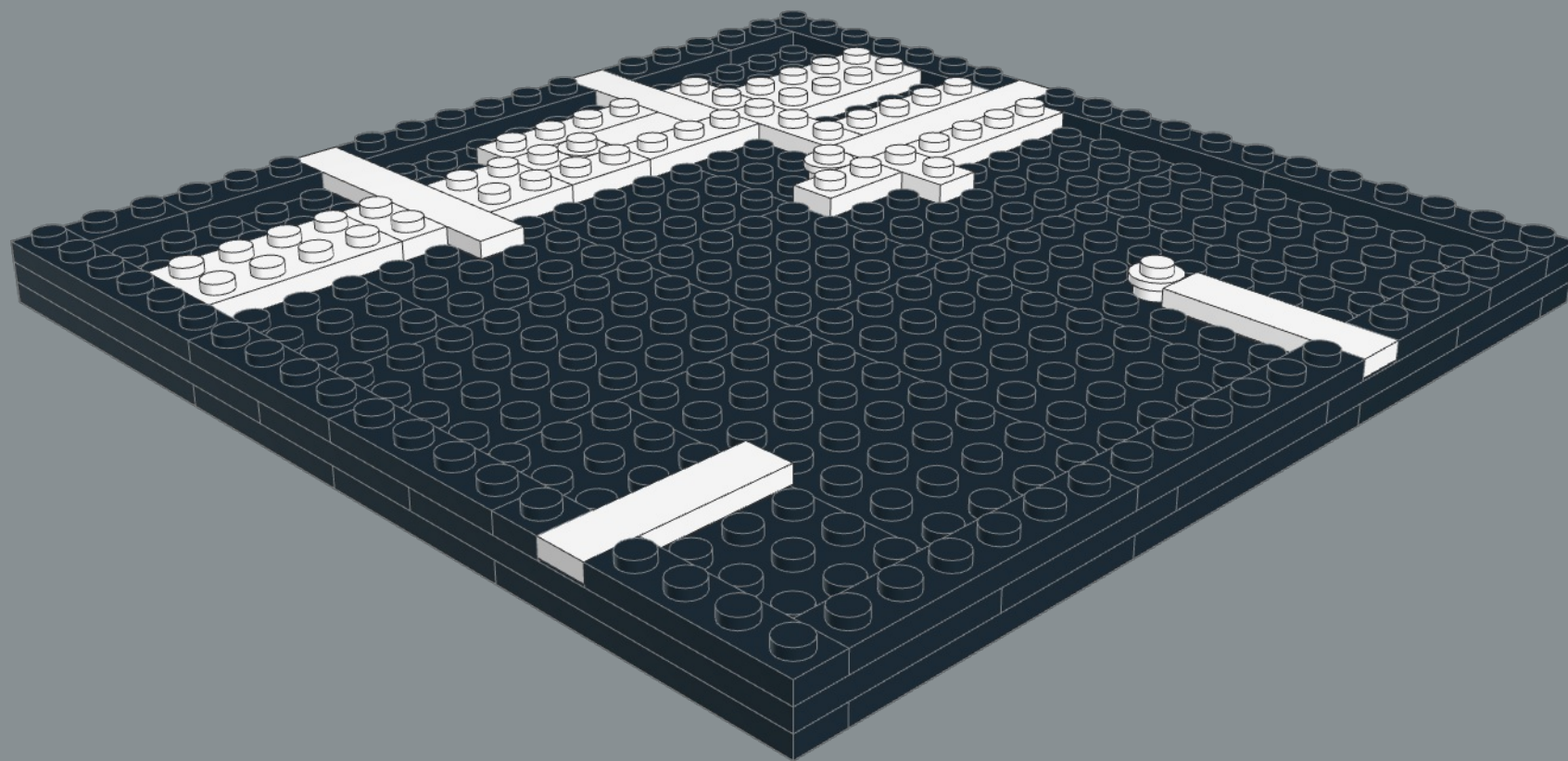
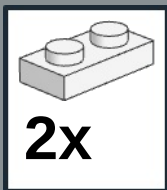

37

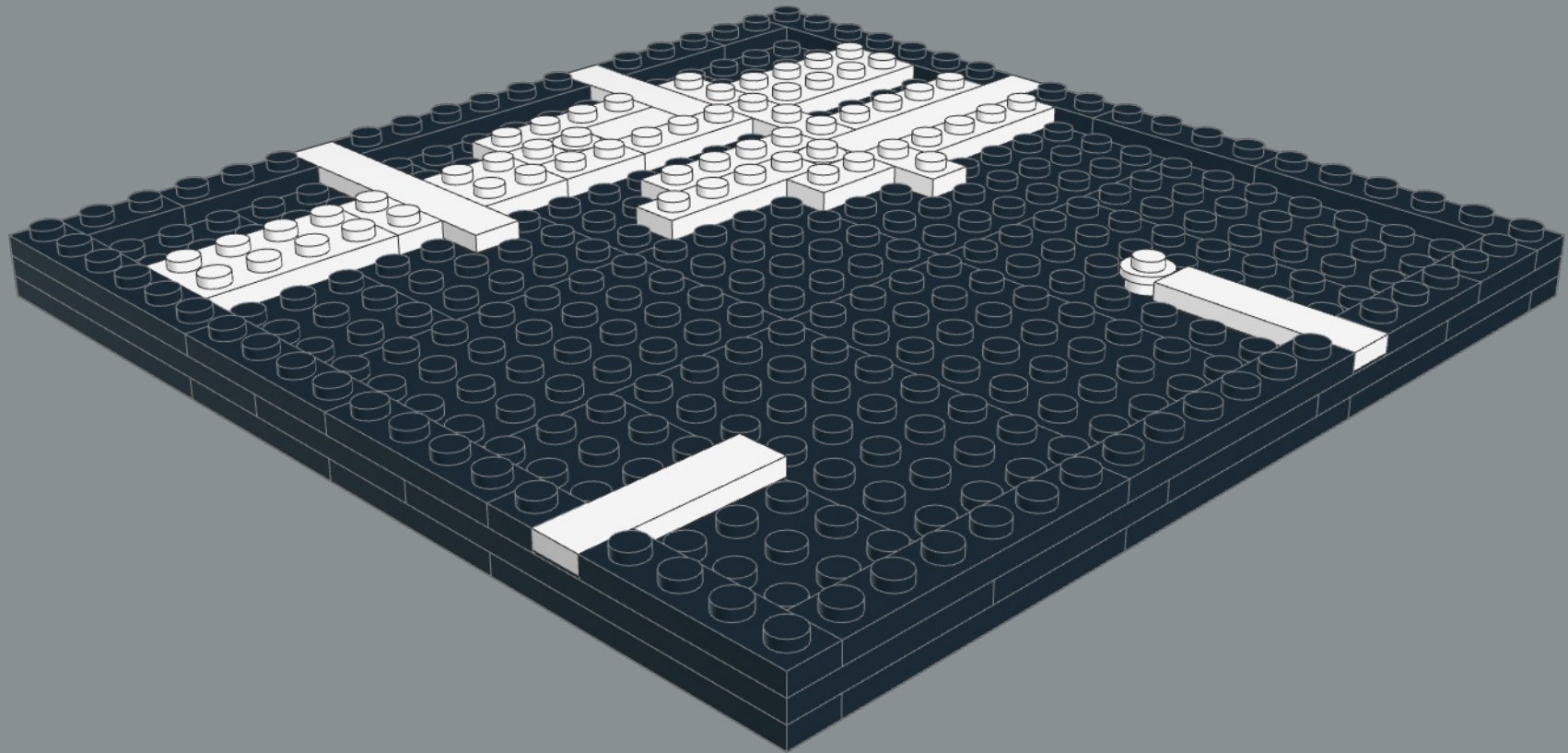
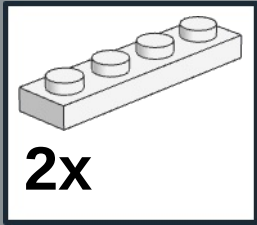

38

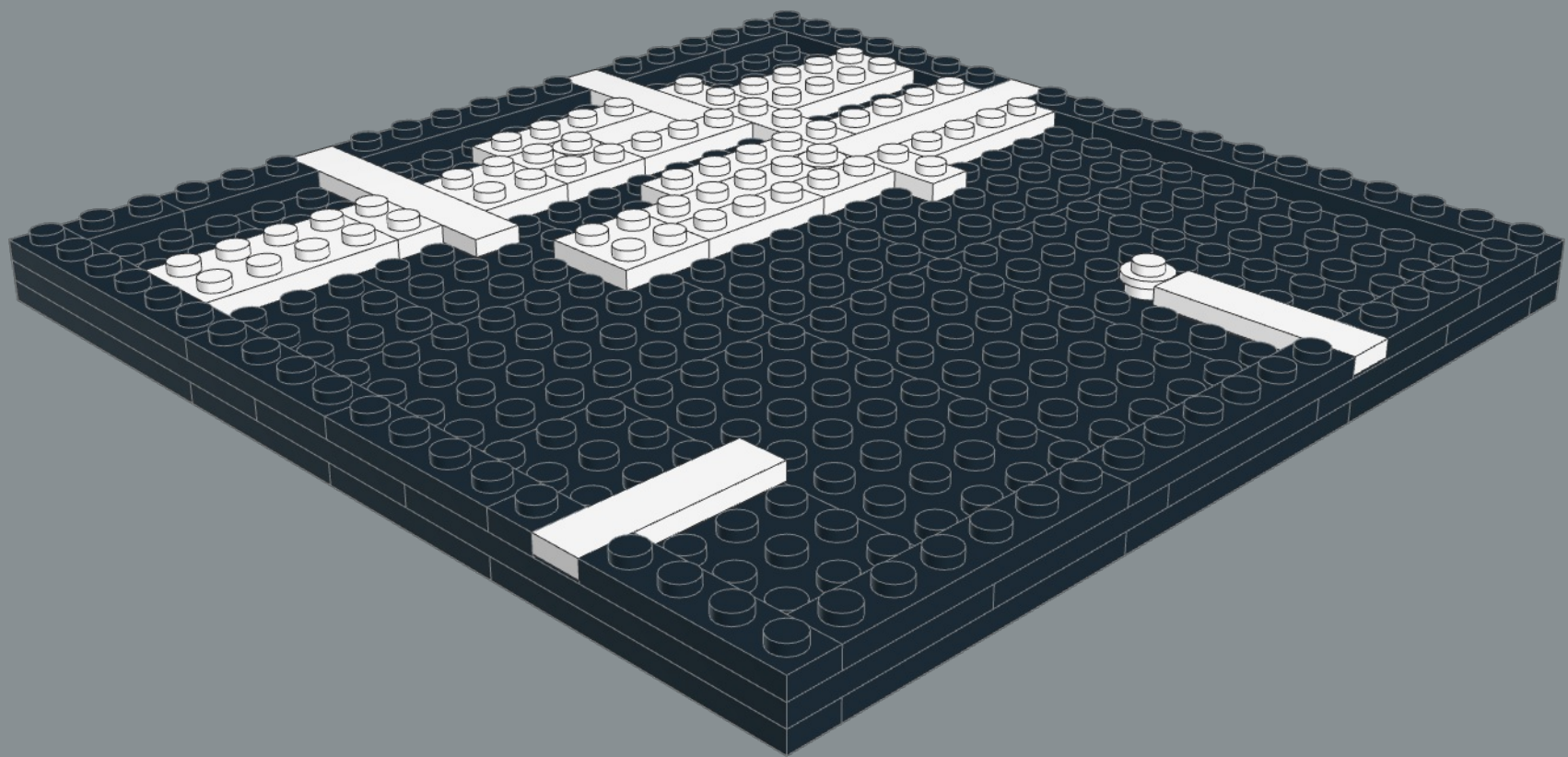
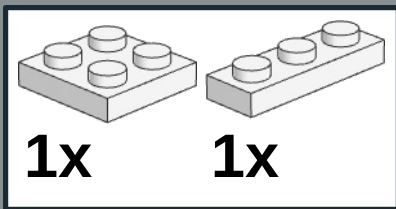

39

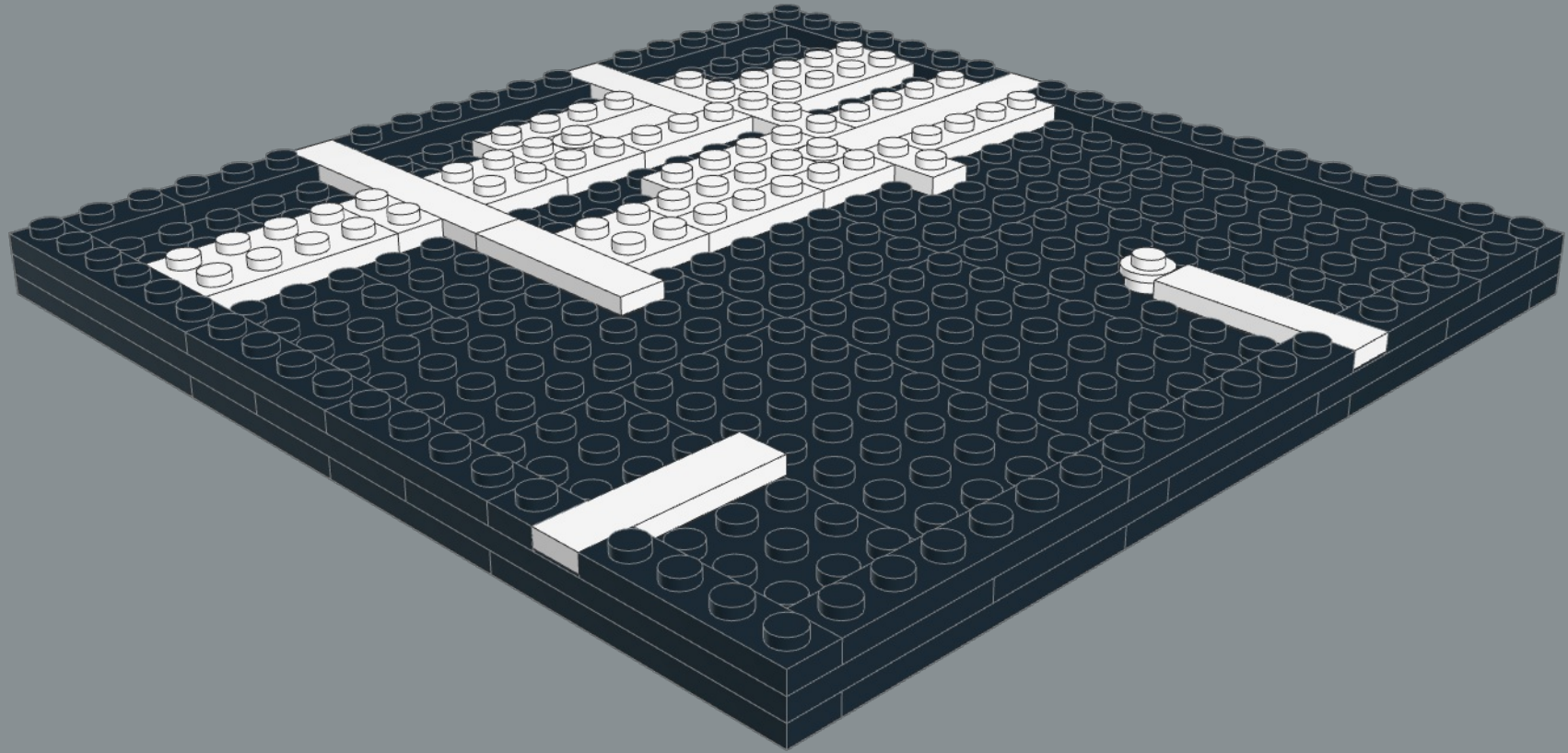
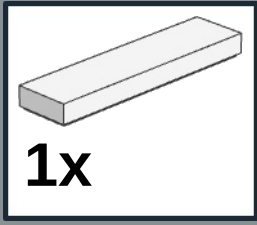

40

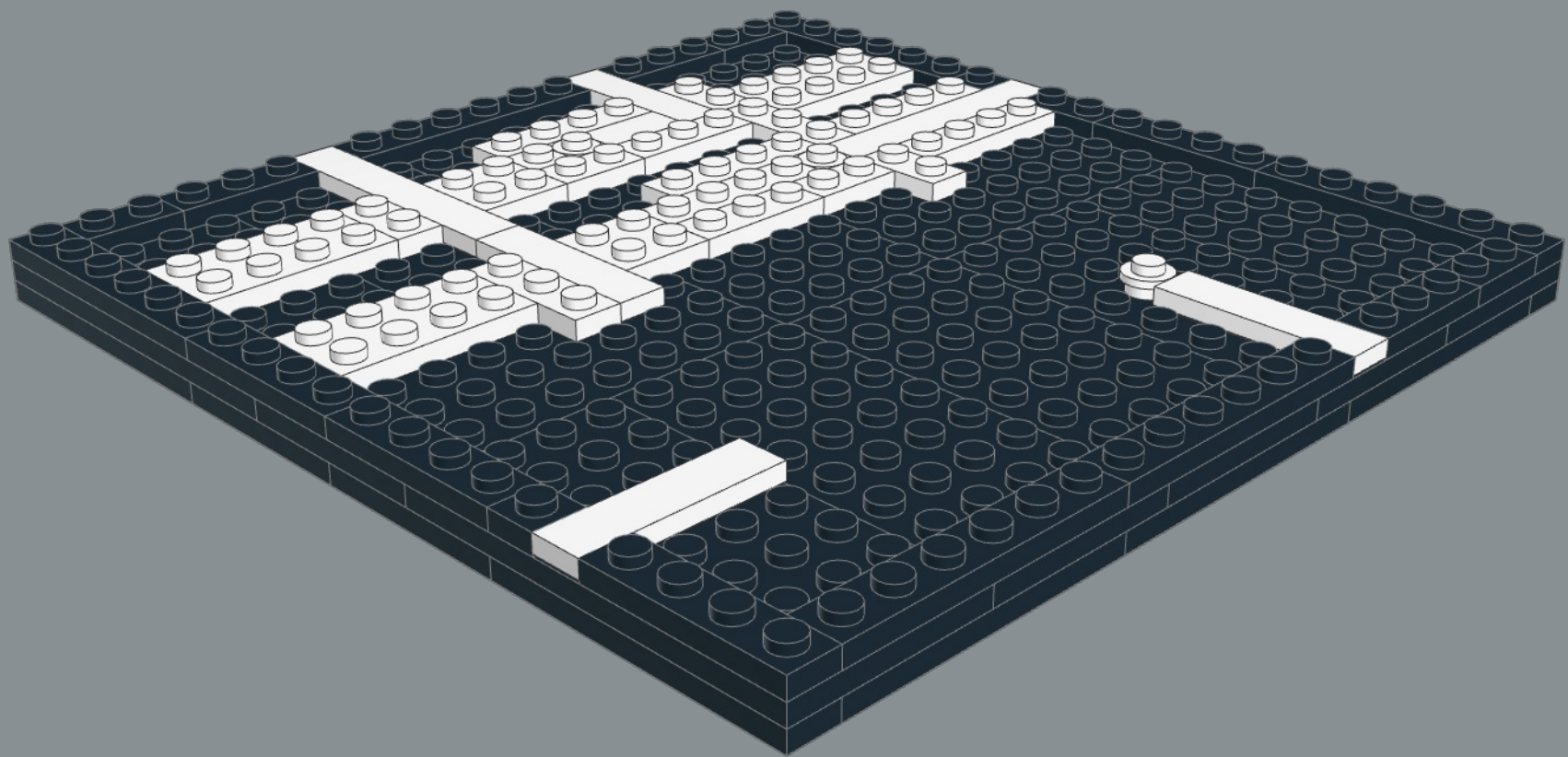
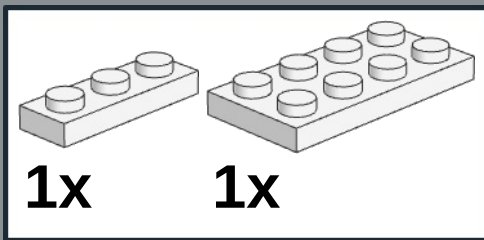

41

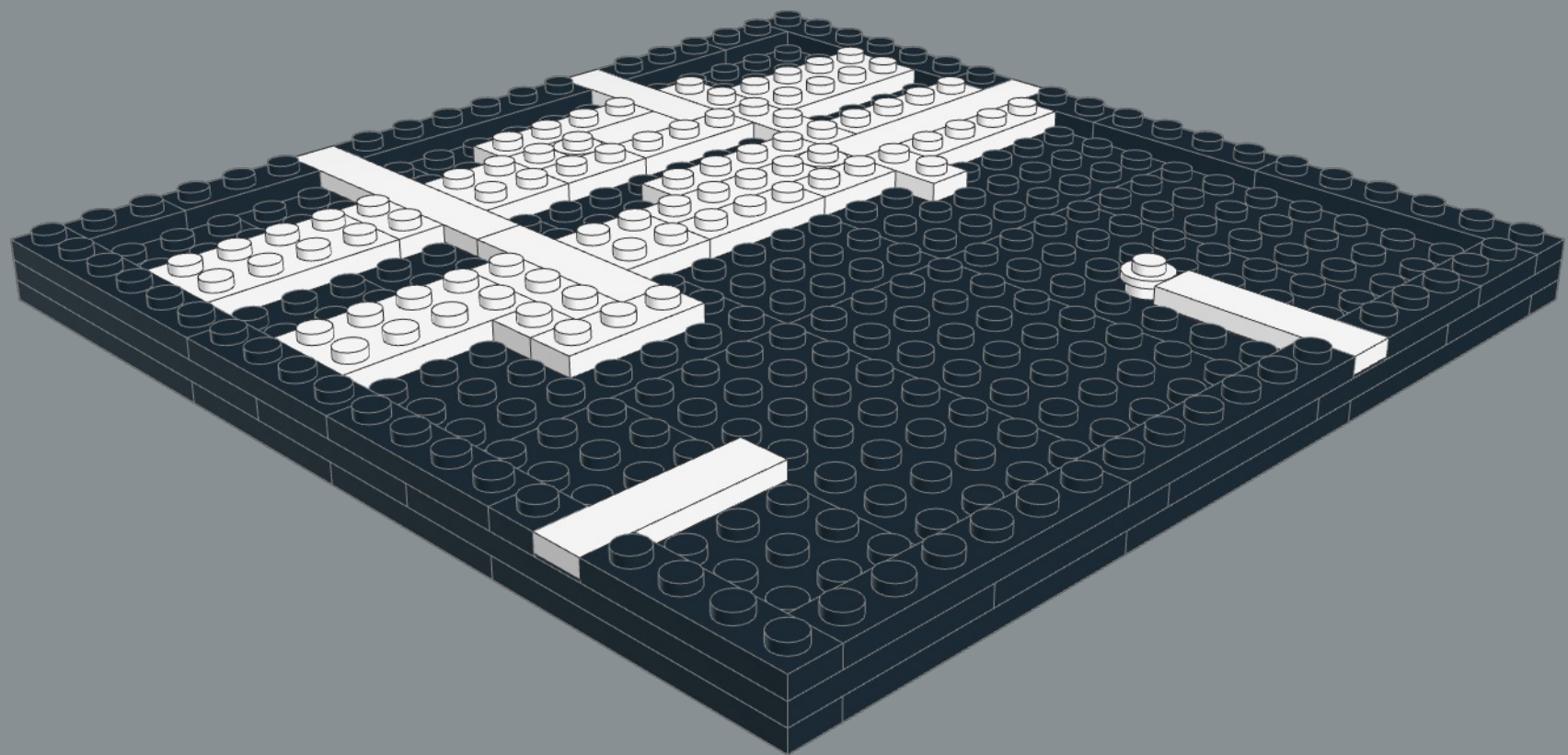
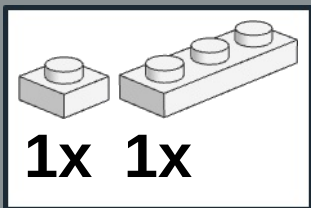

42

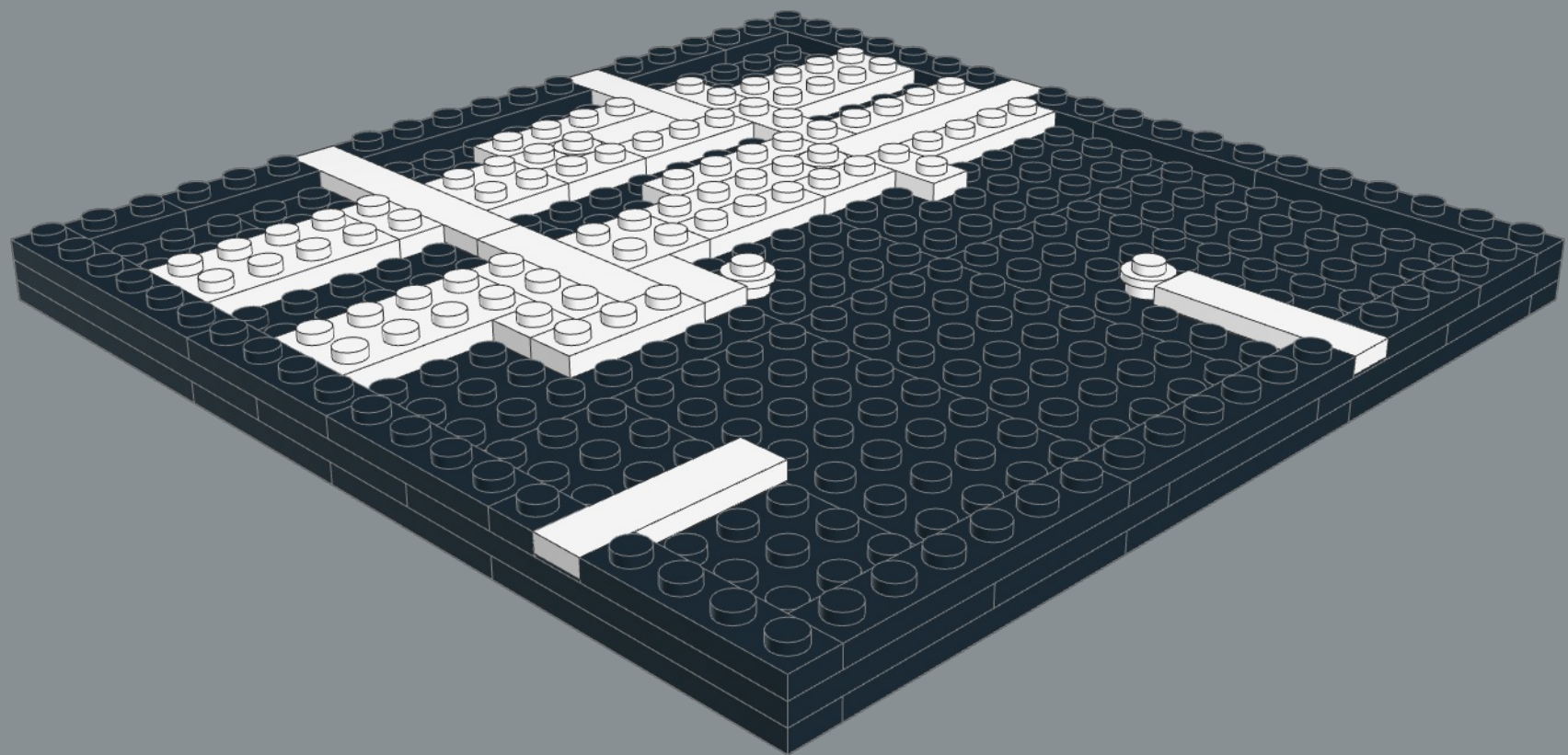
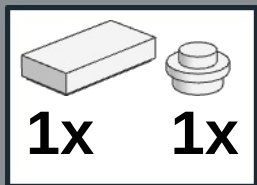

43

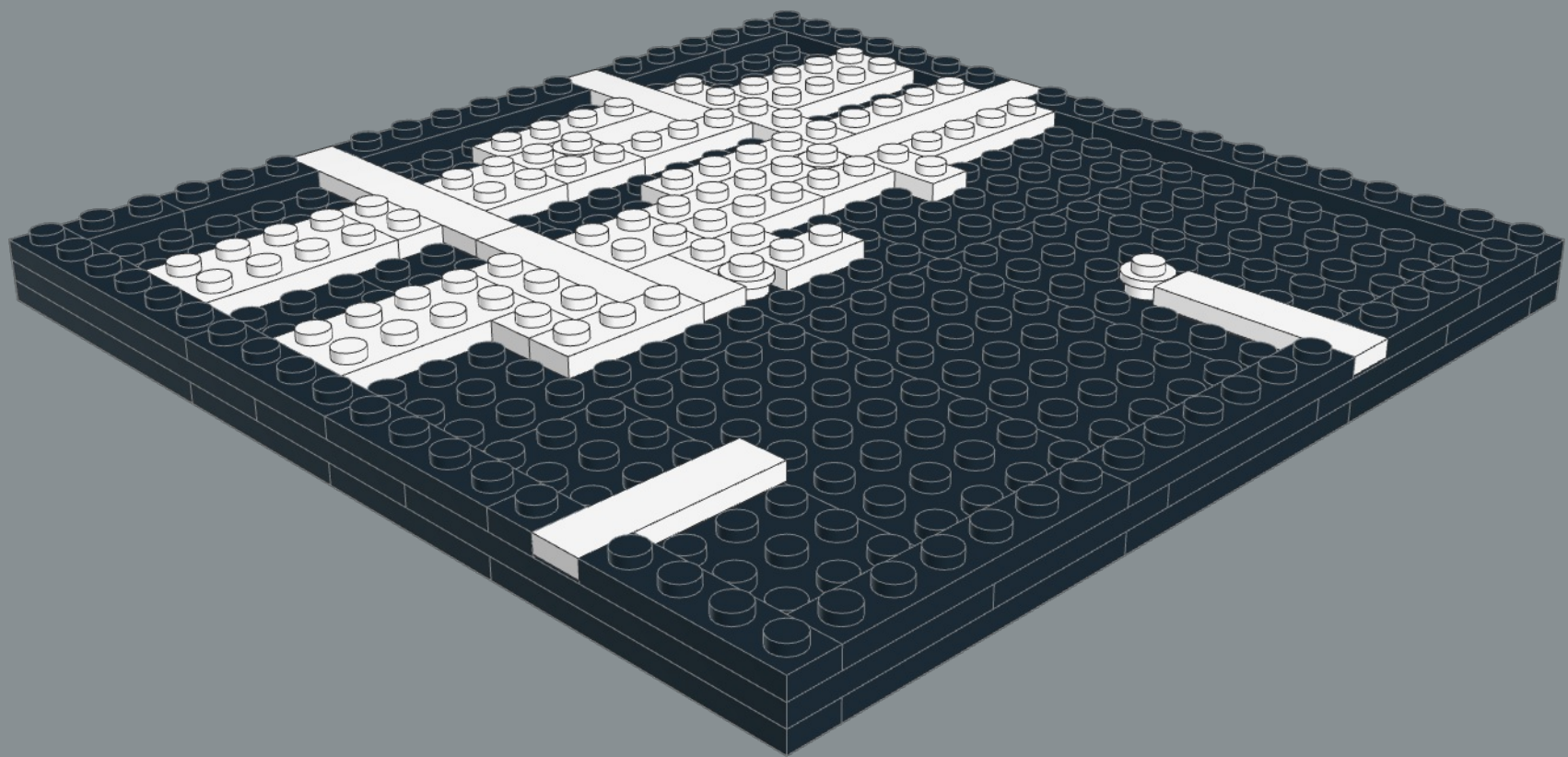
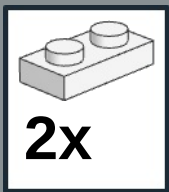

44

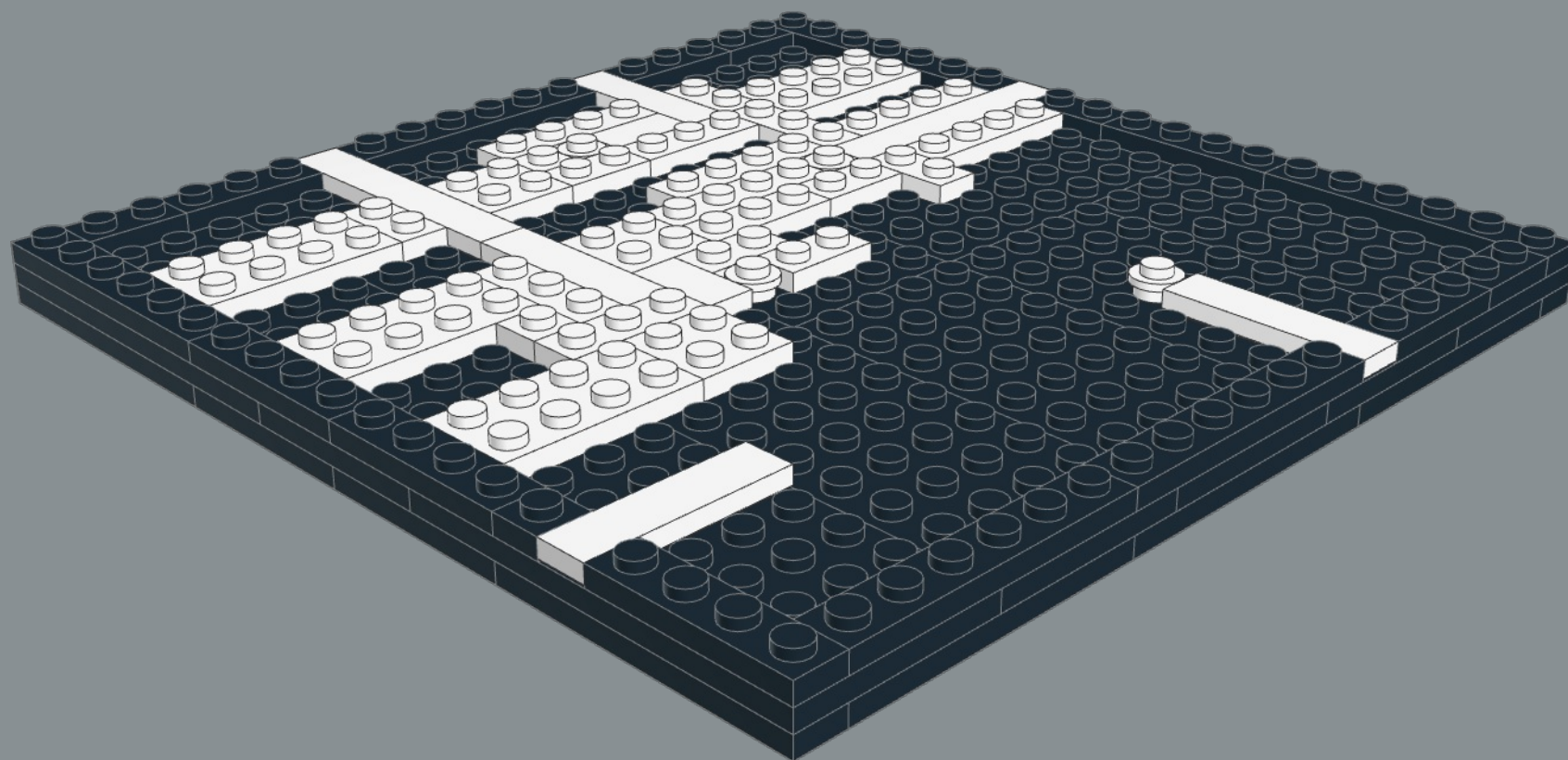
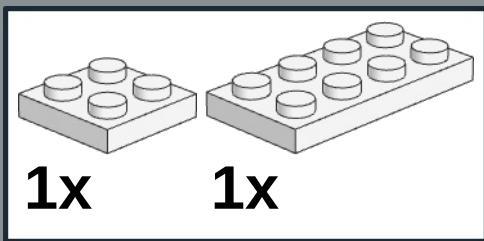

45

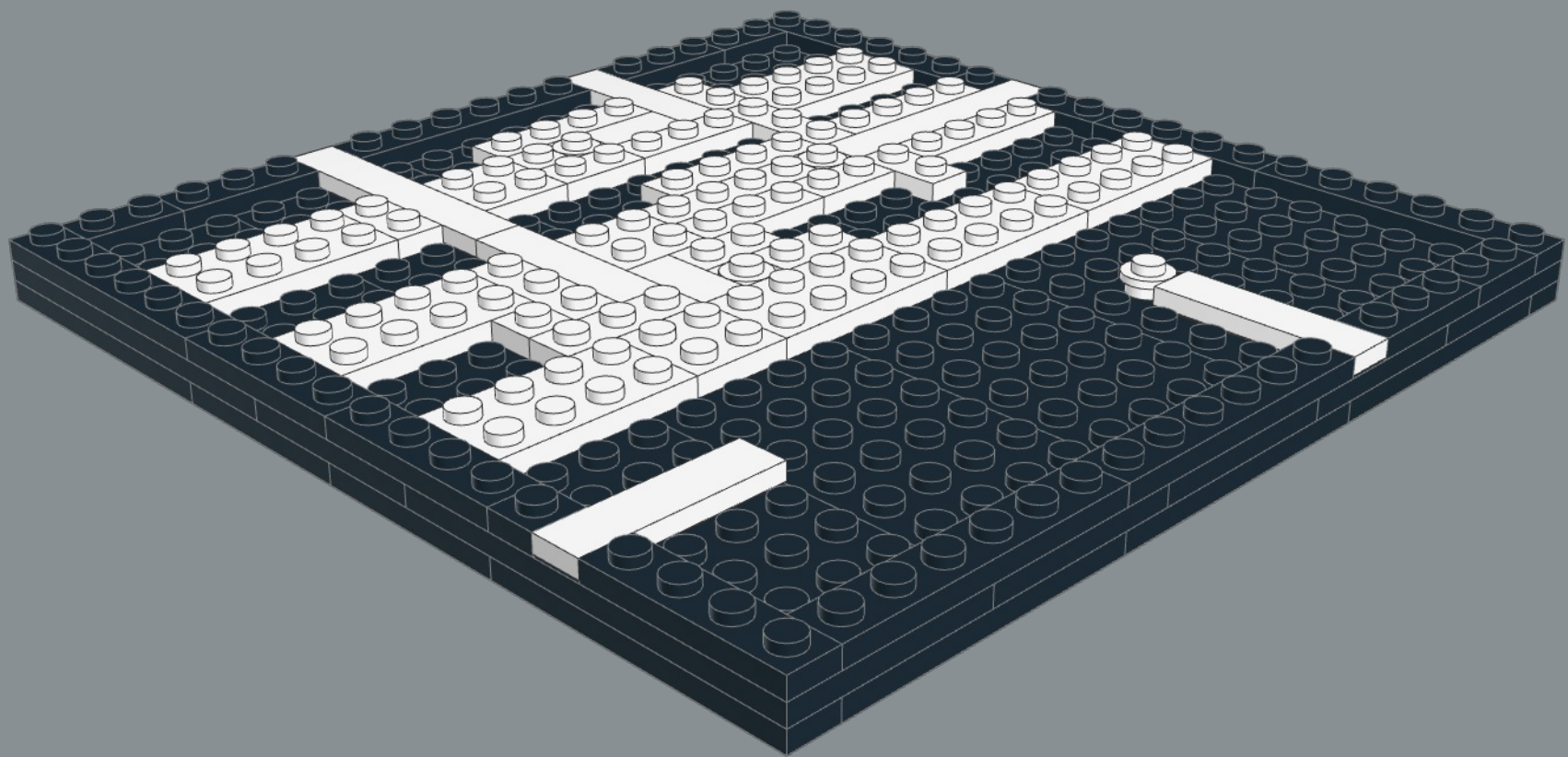
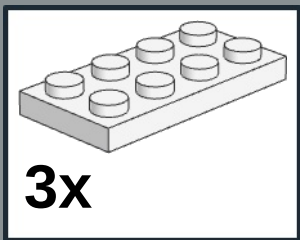

46

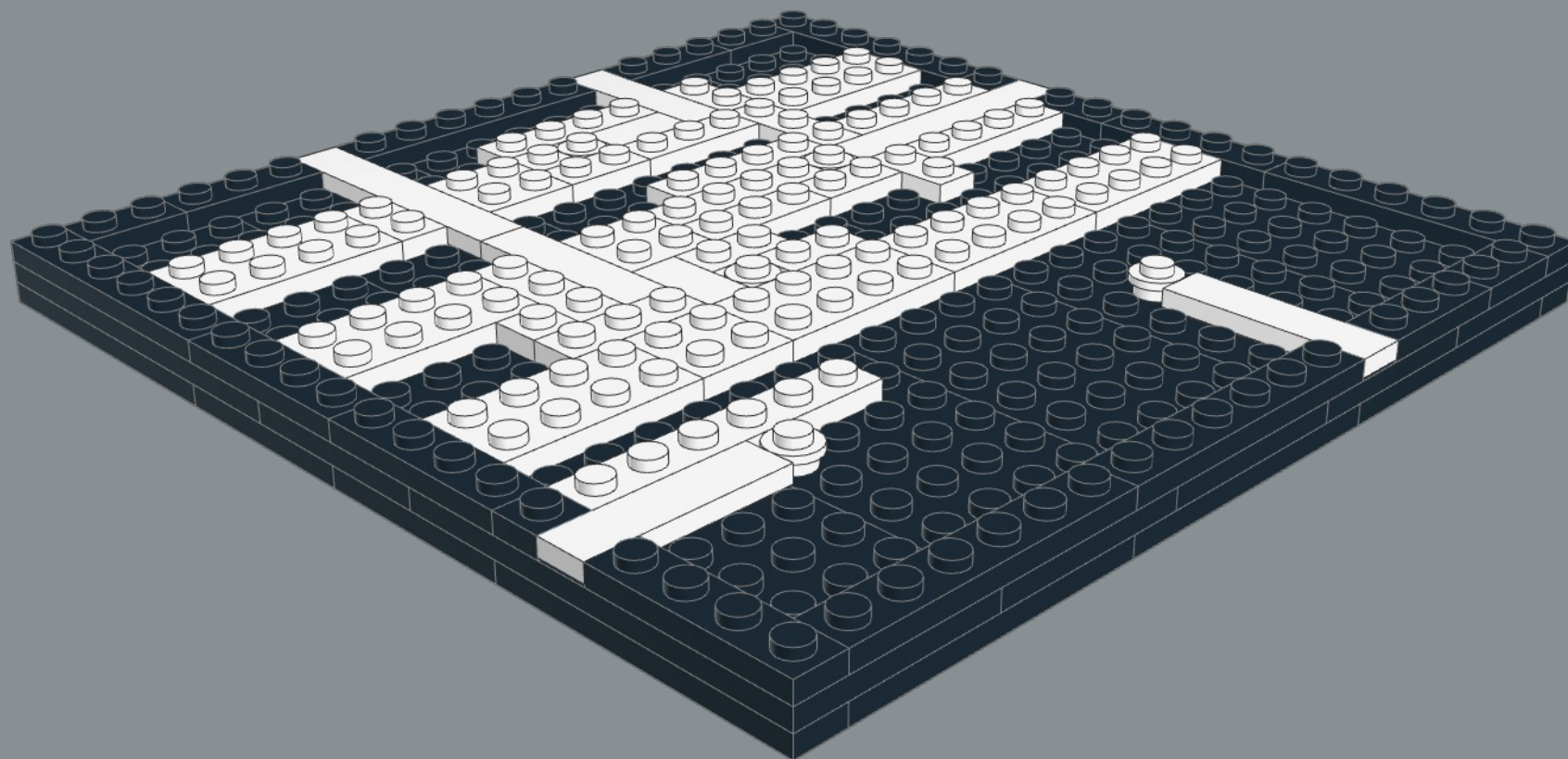
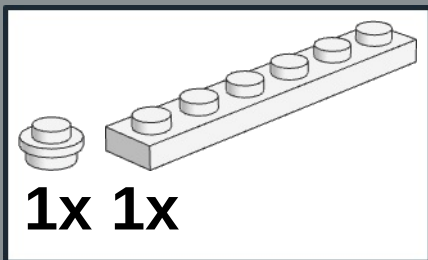

47

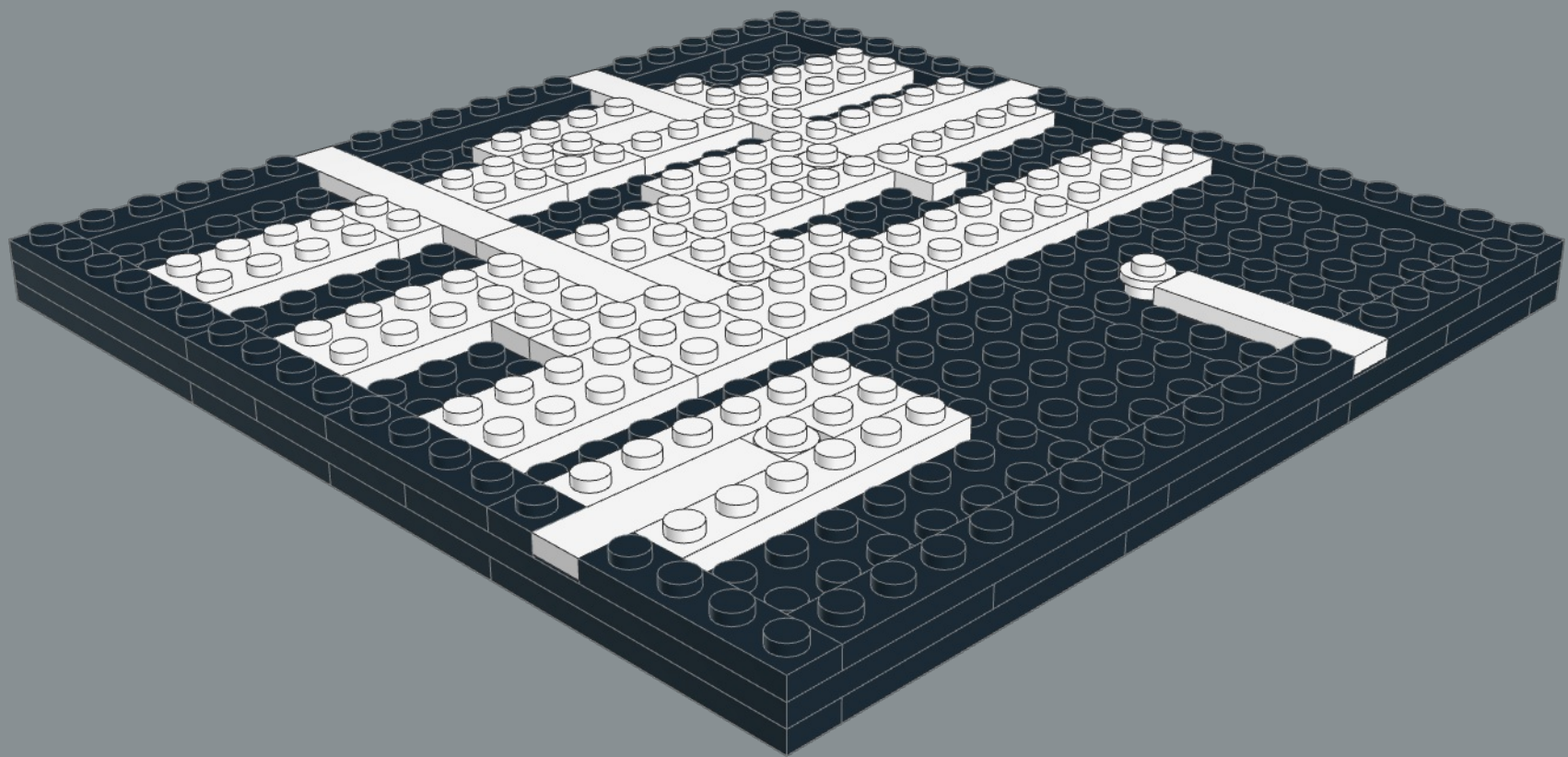
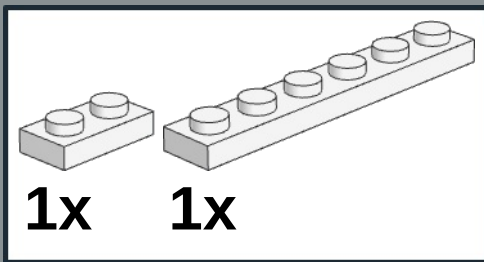

48

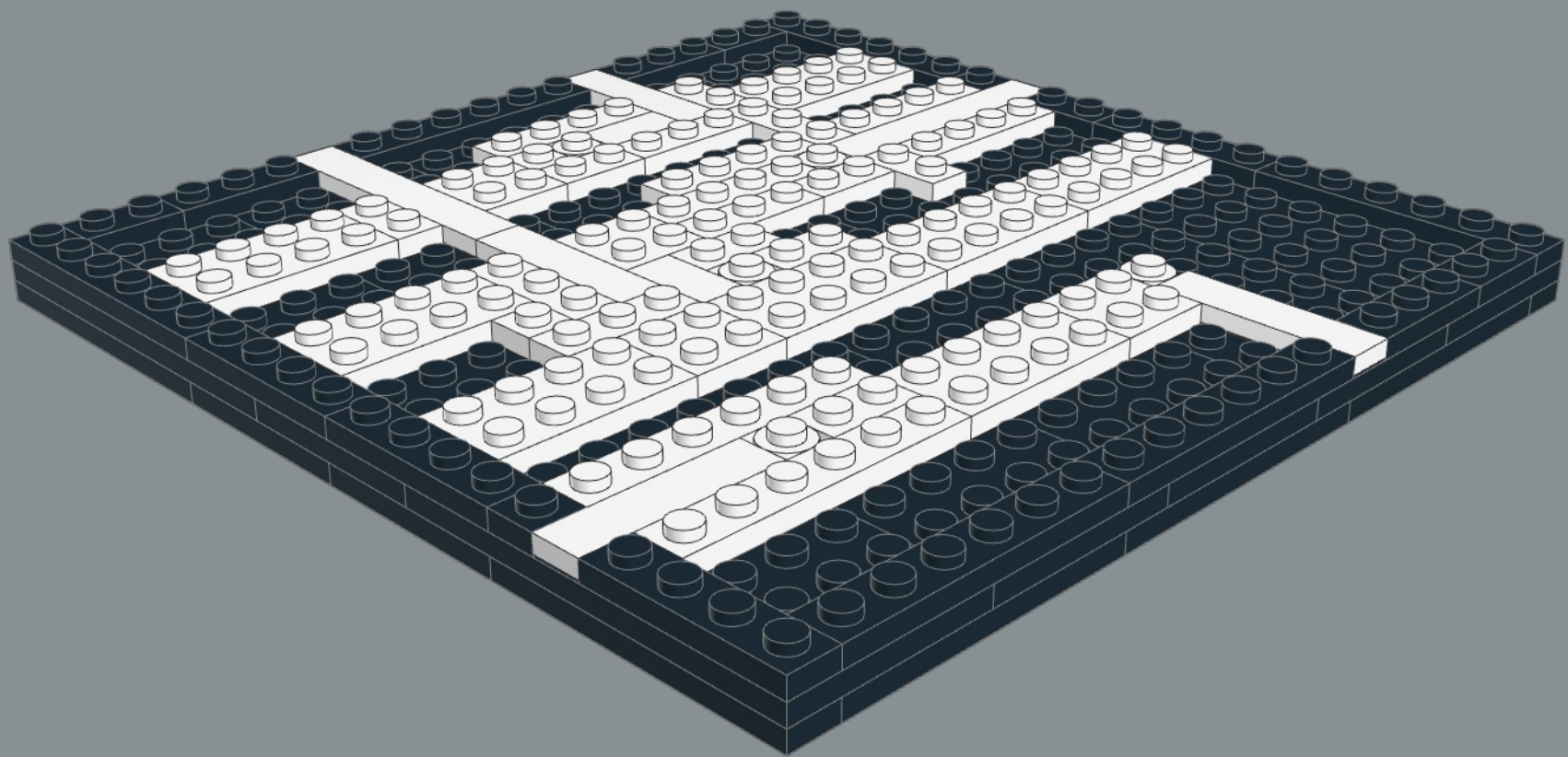
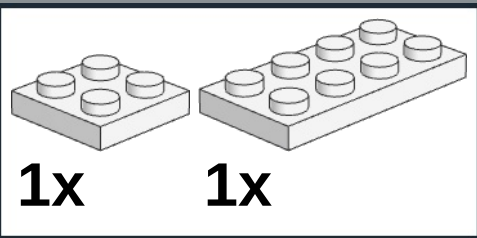

49

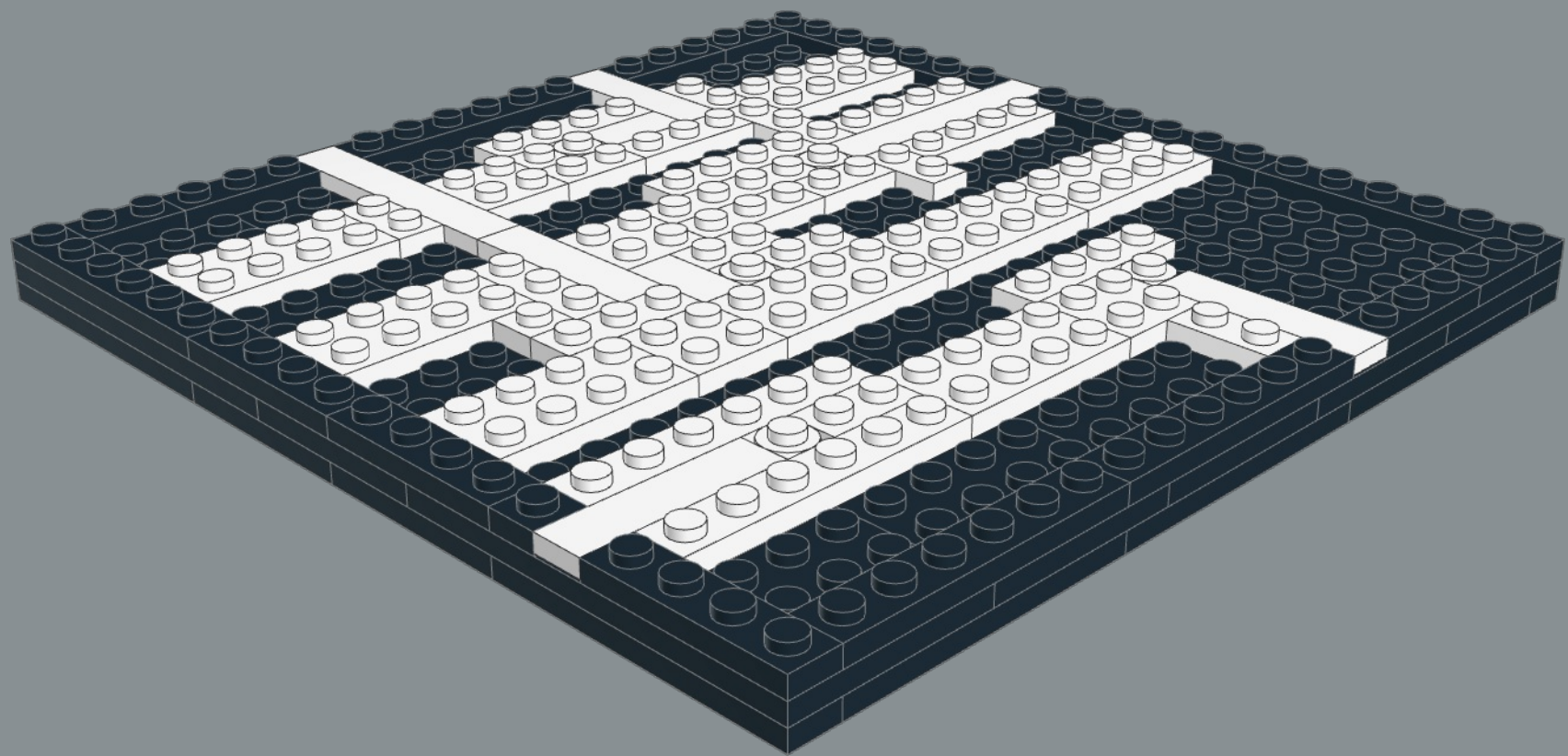
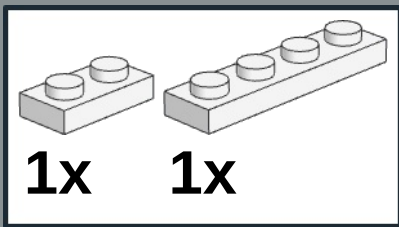

50

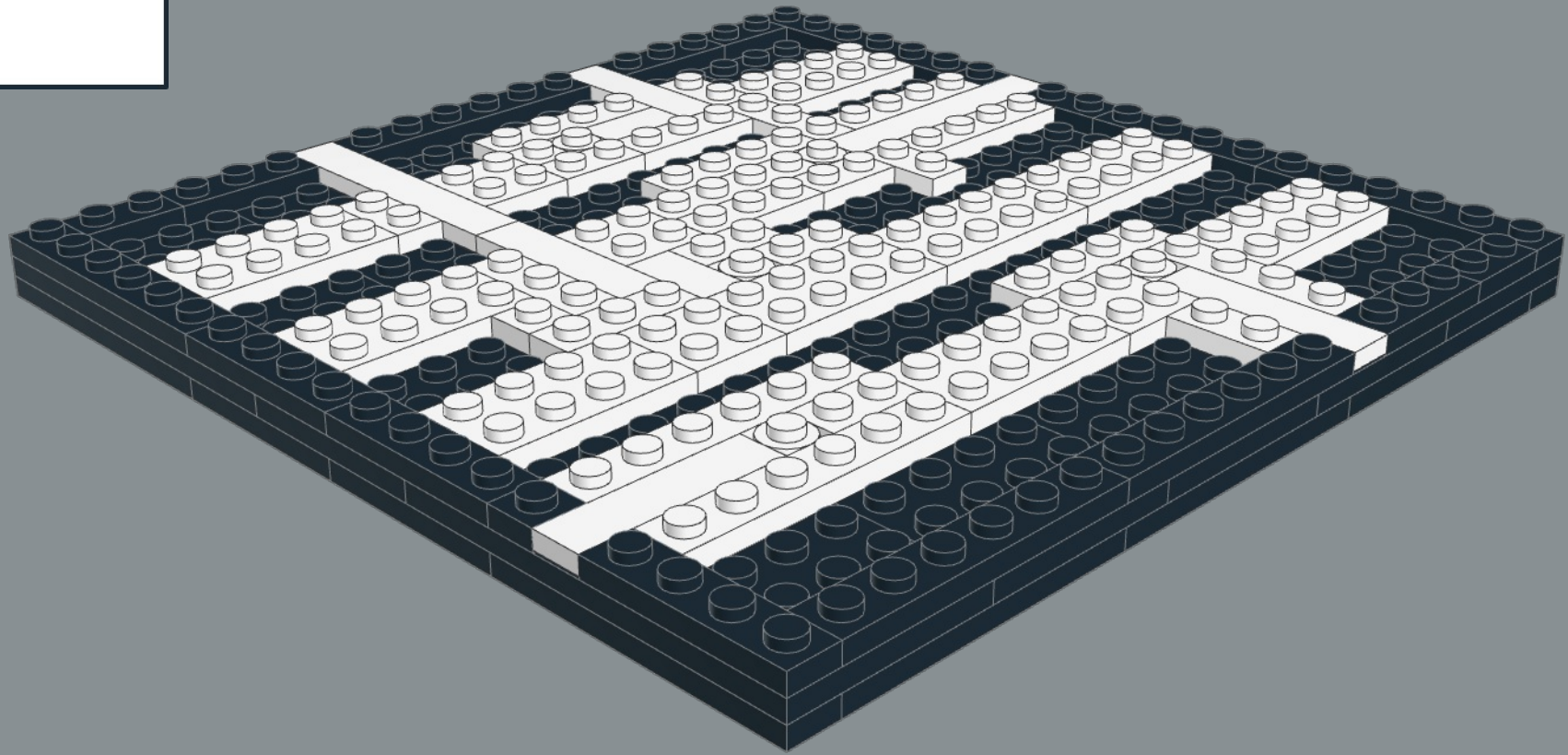
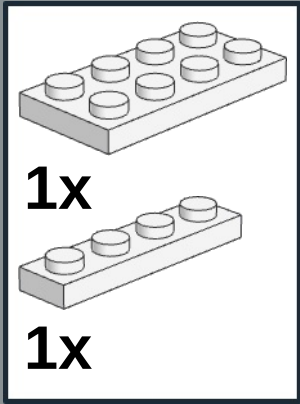

51

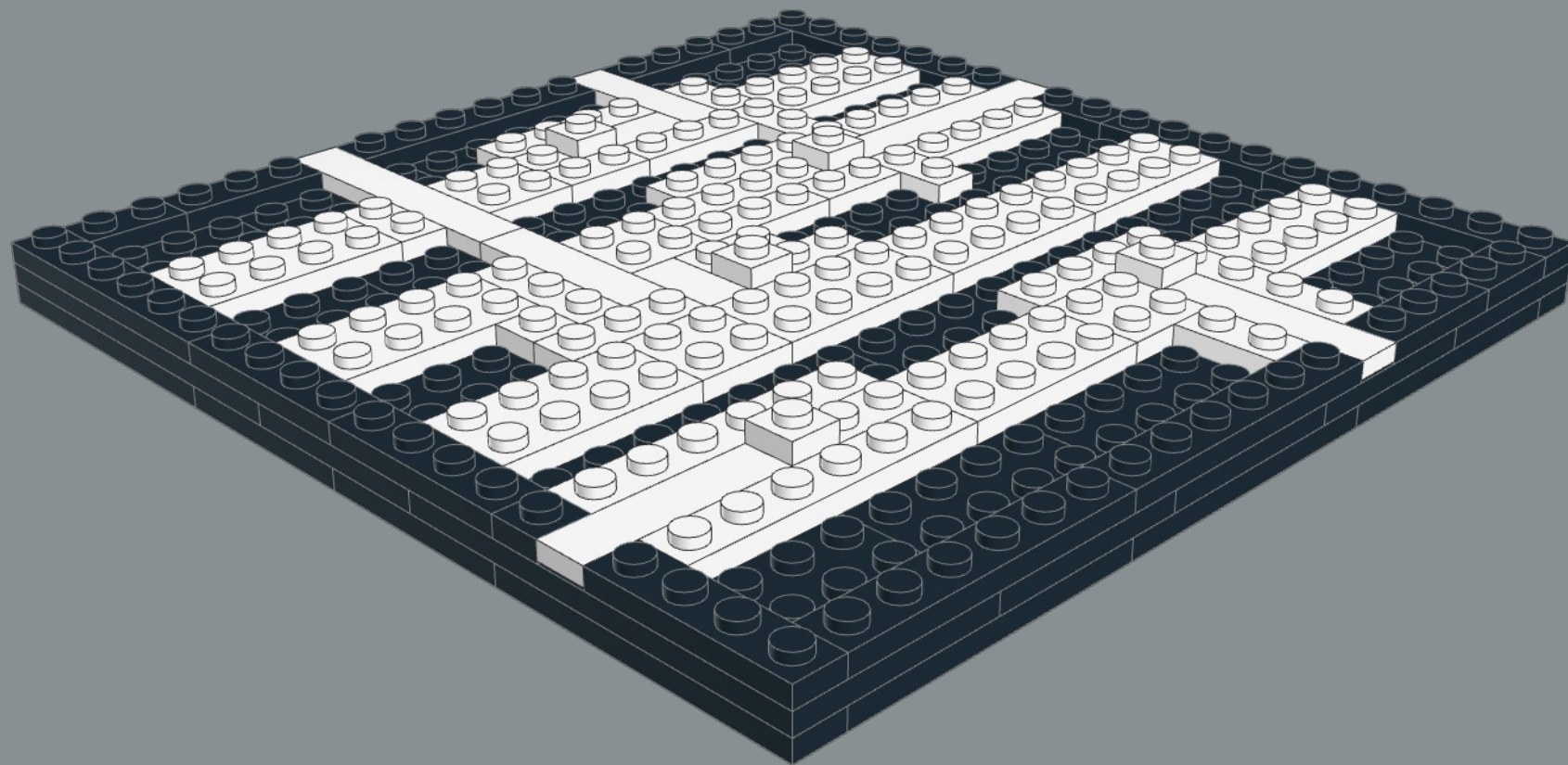

52

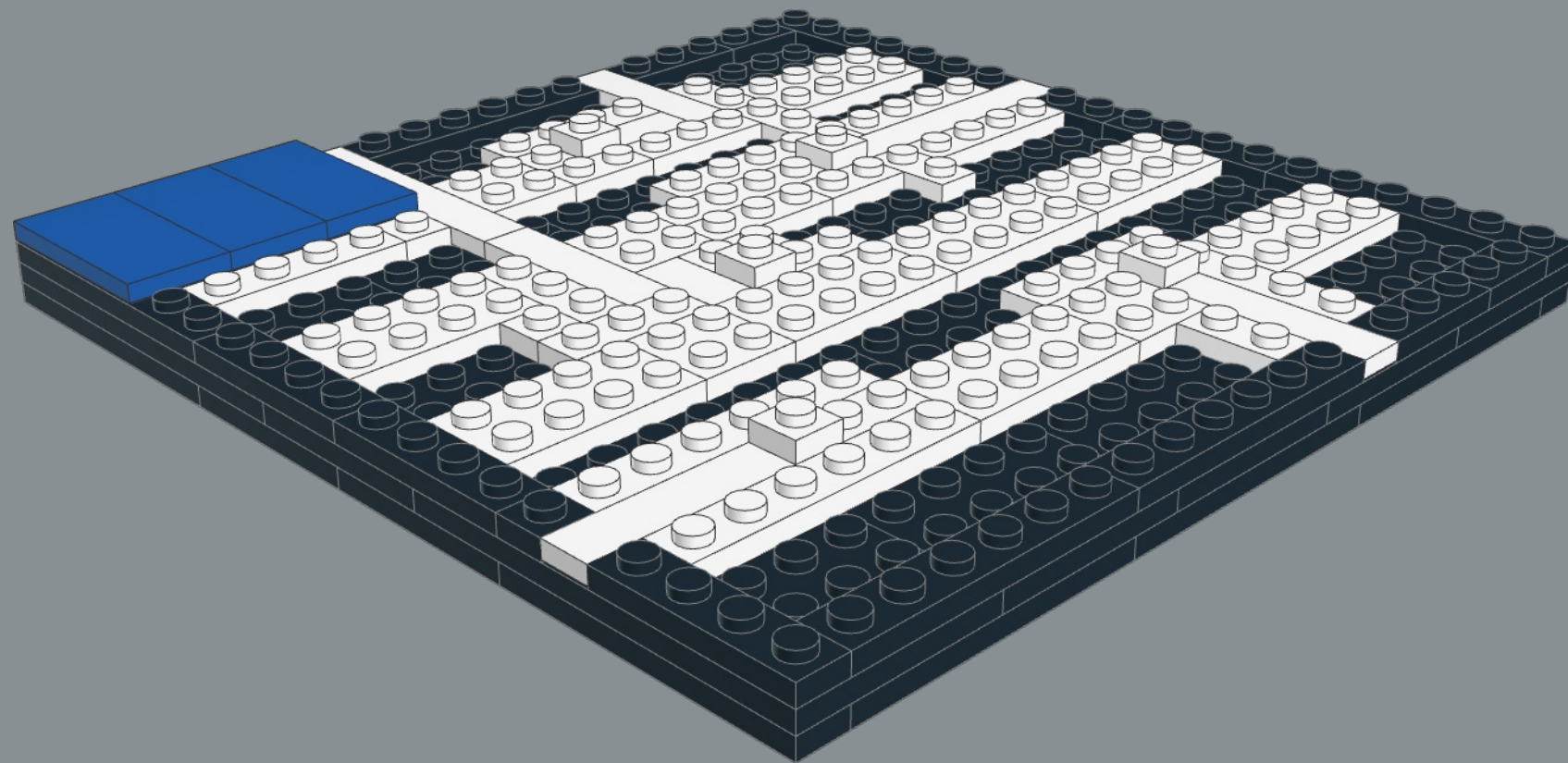
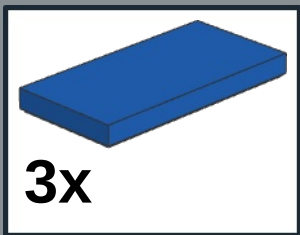

53

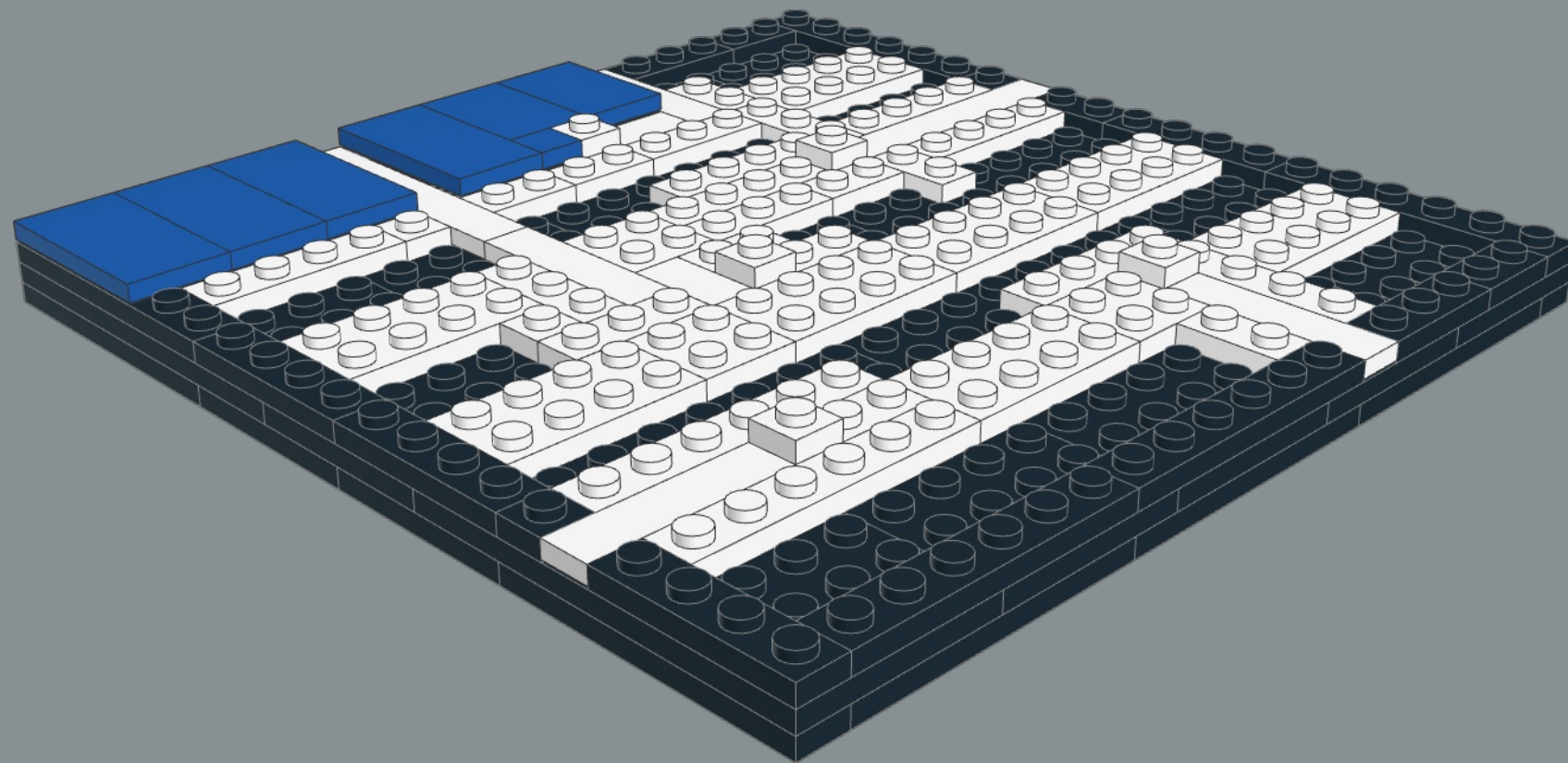
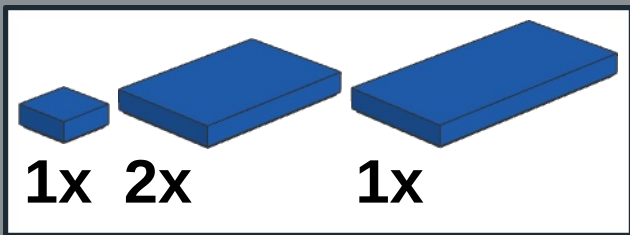

54

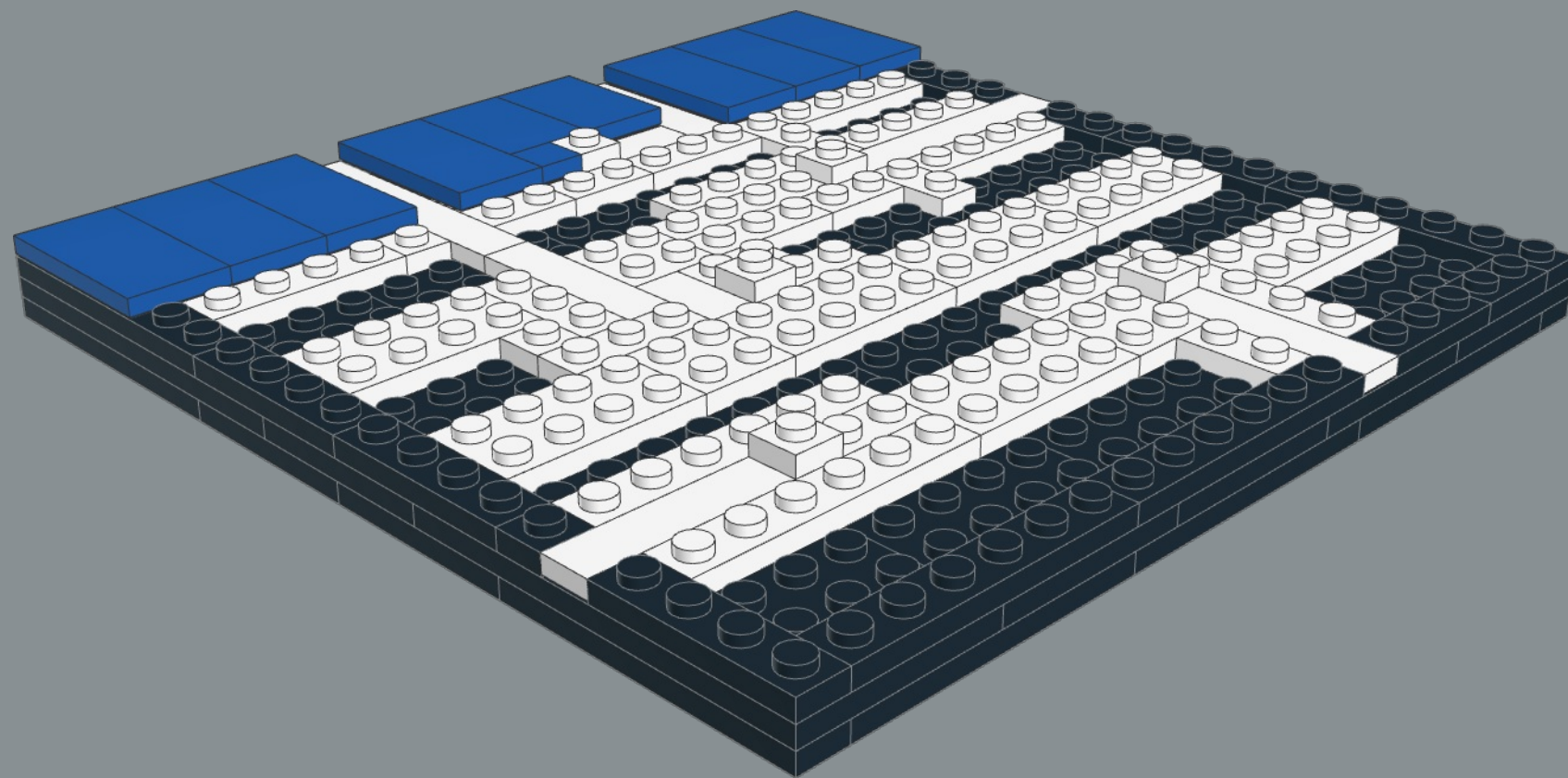
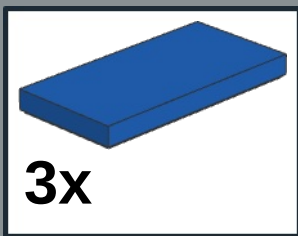

55

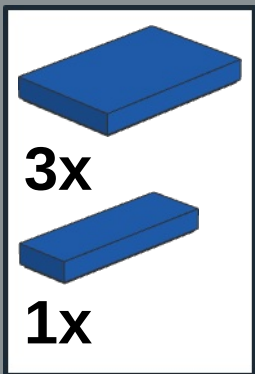

3x

1x

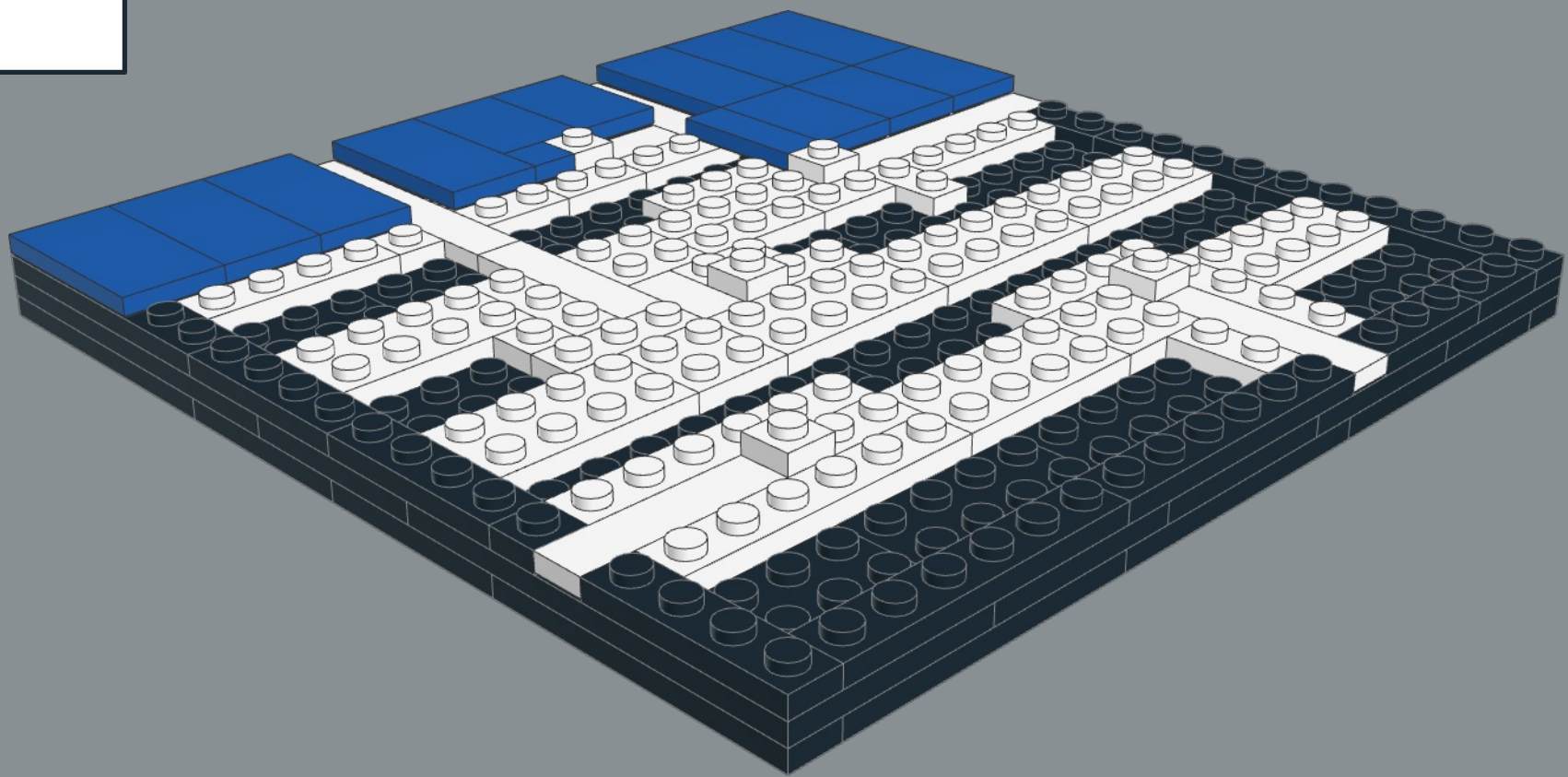

56

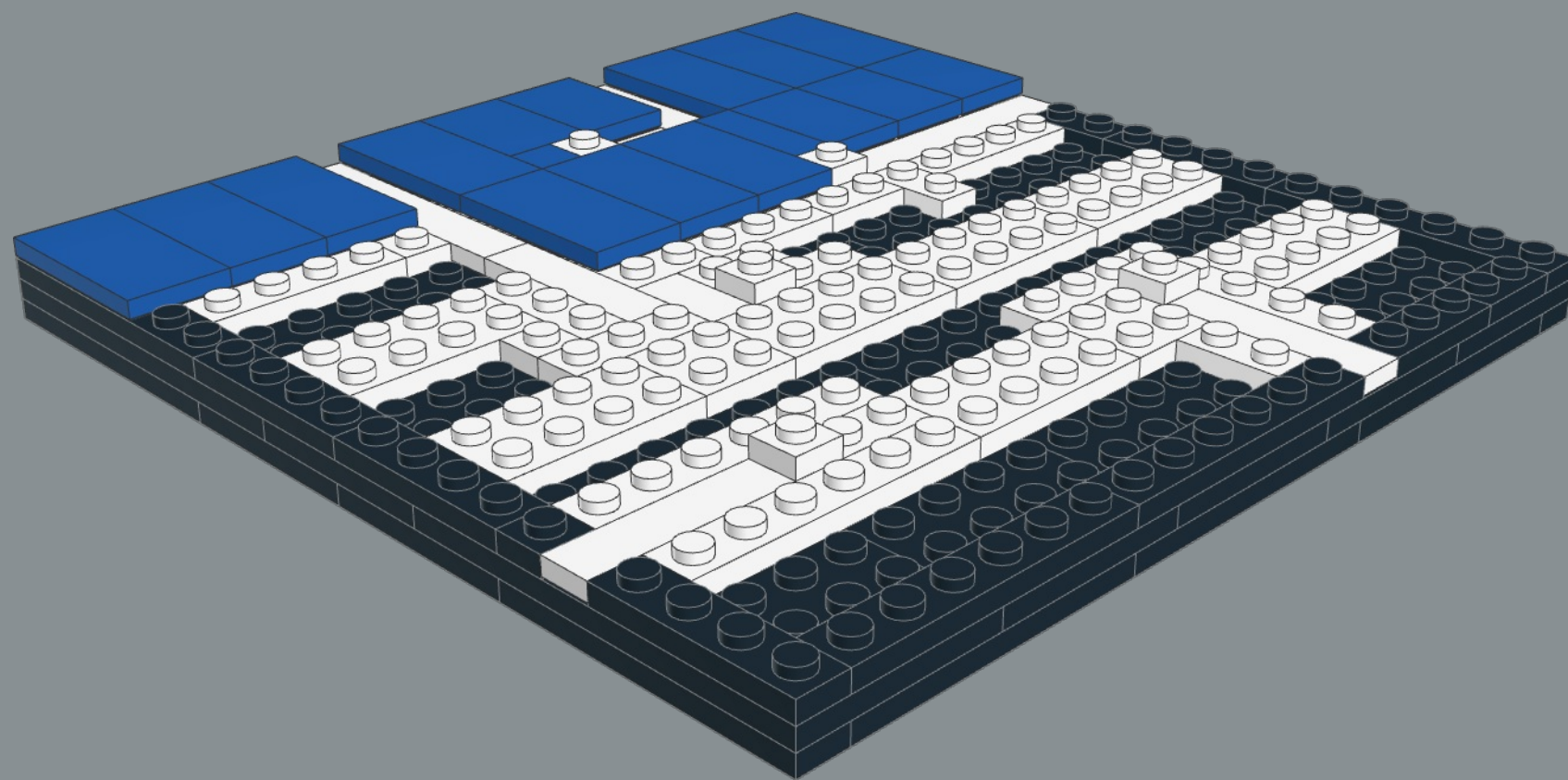
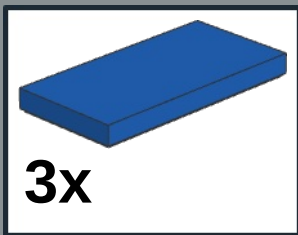

57

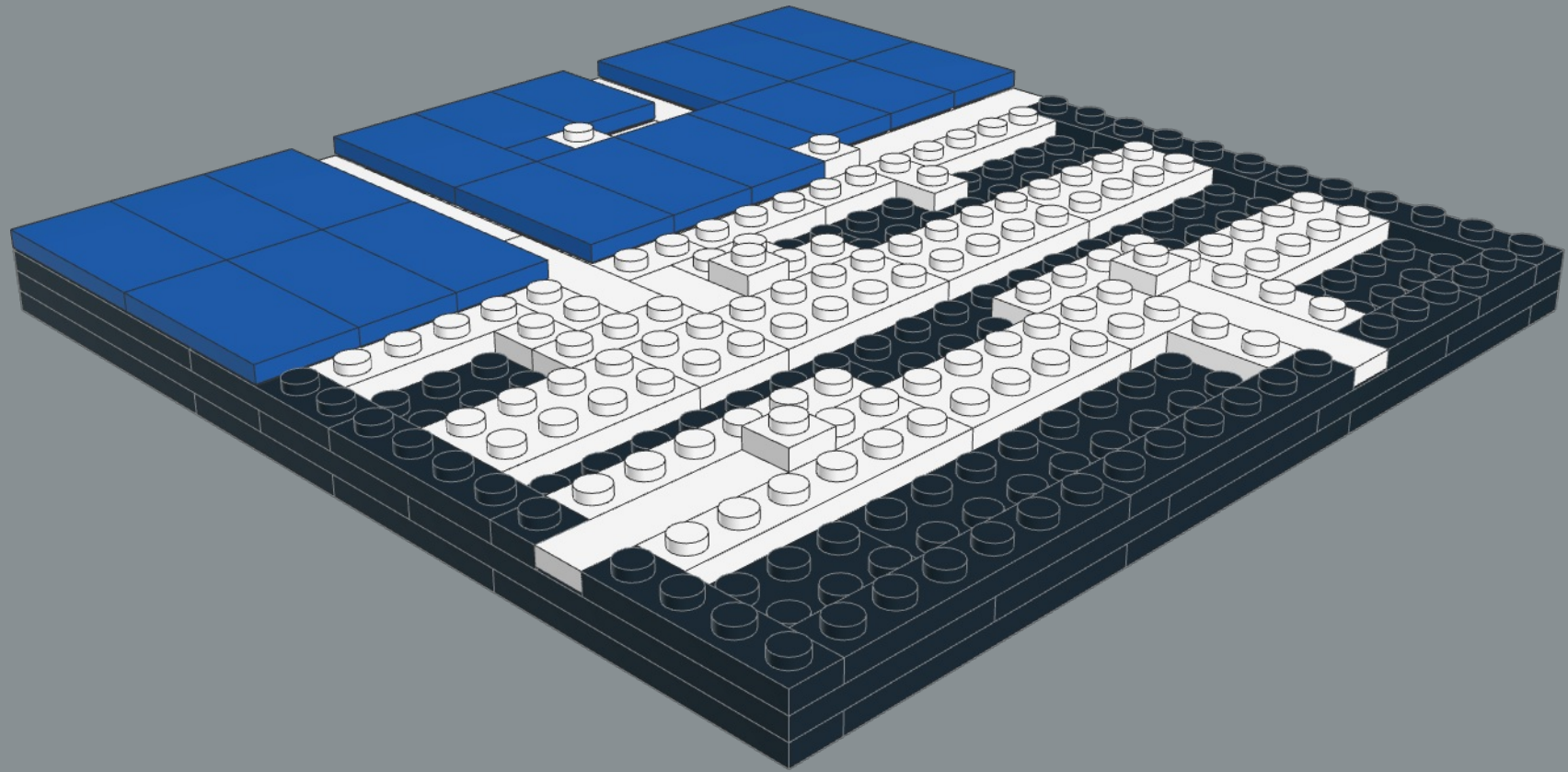
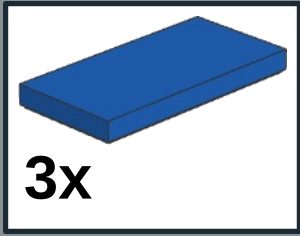

58

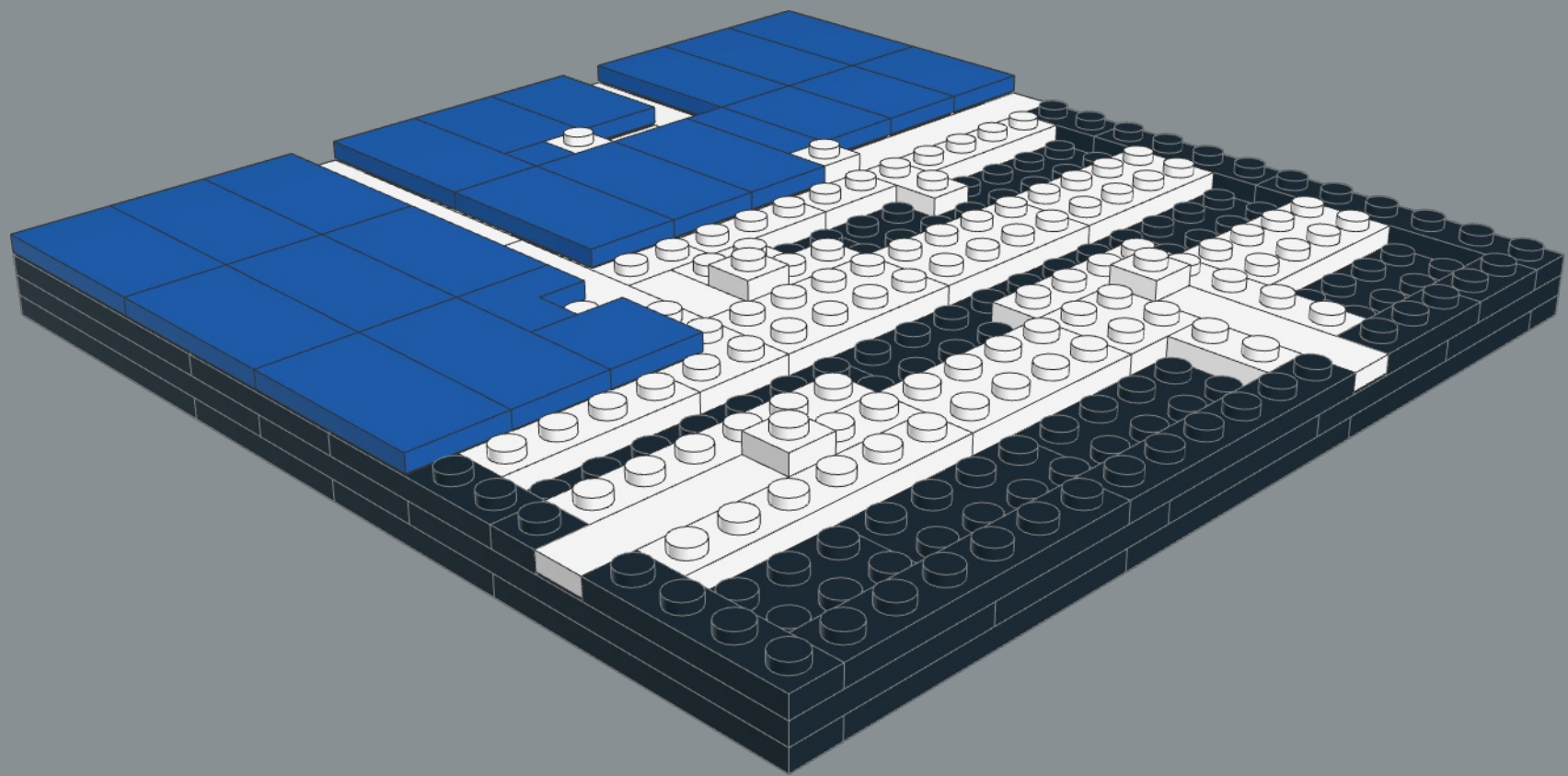
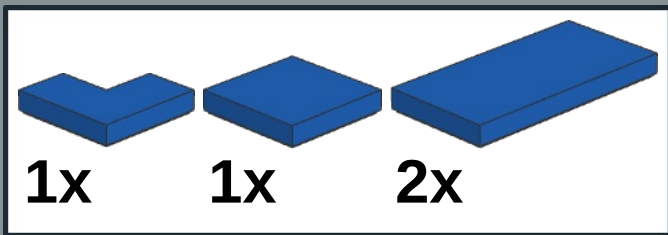

59

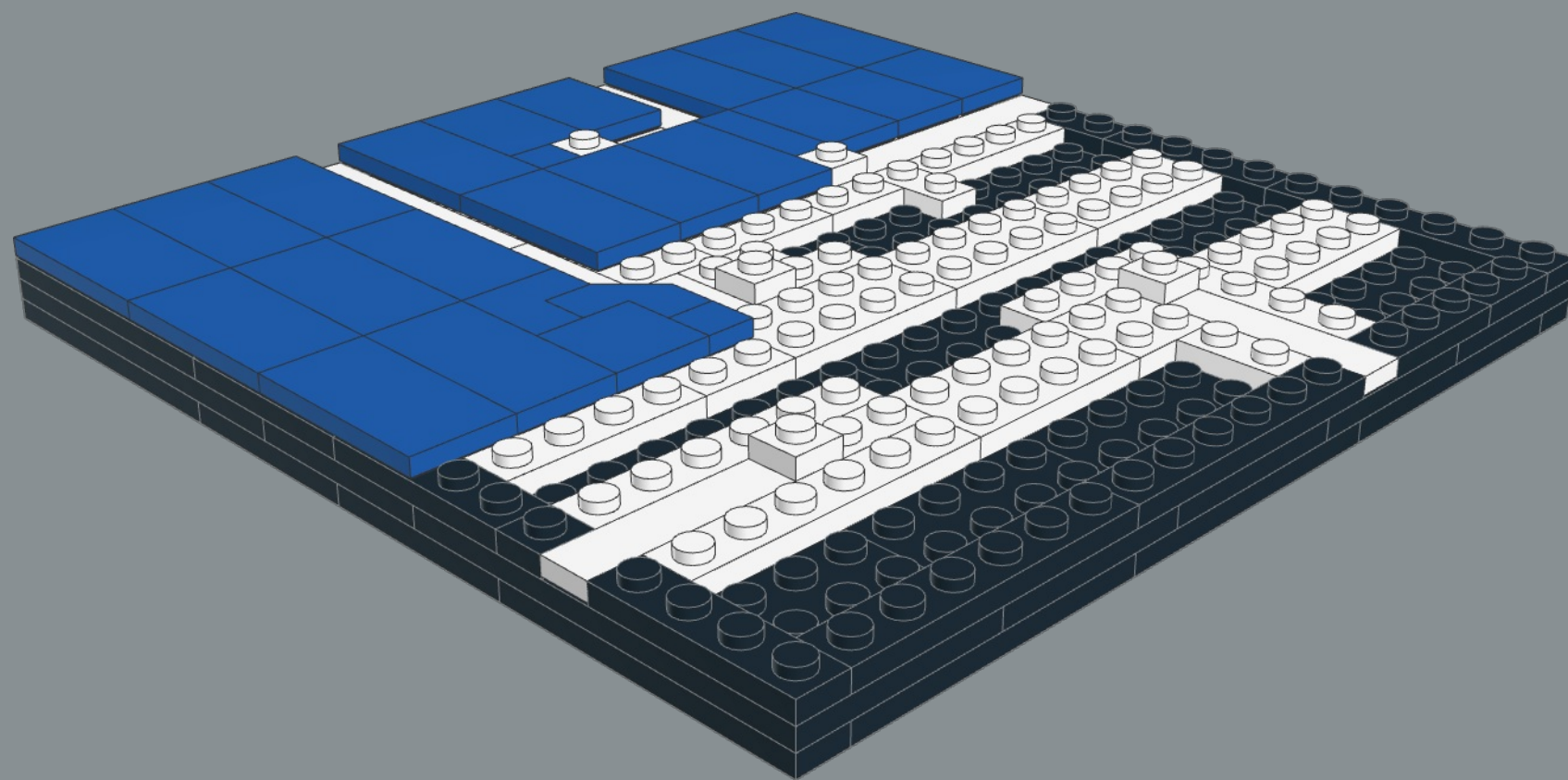
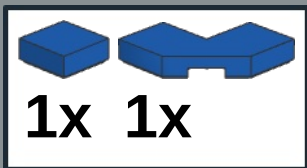

60

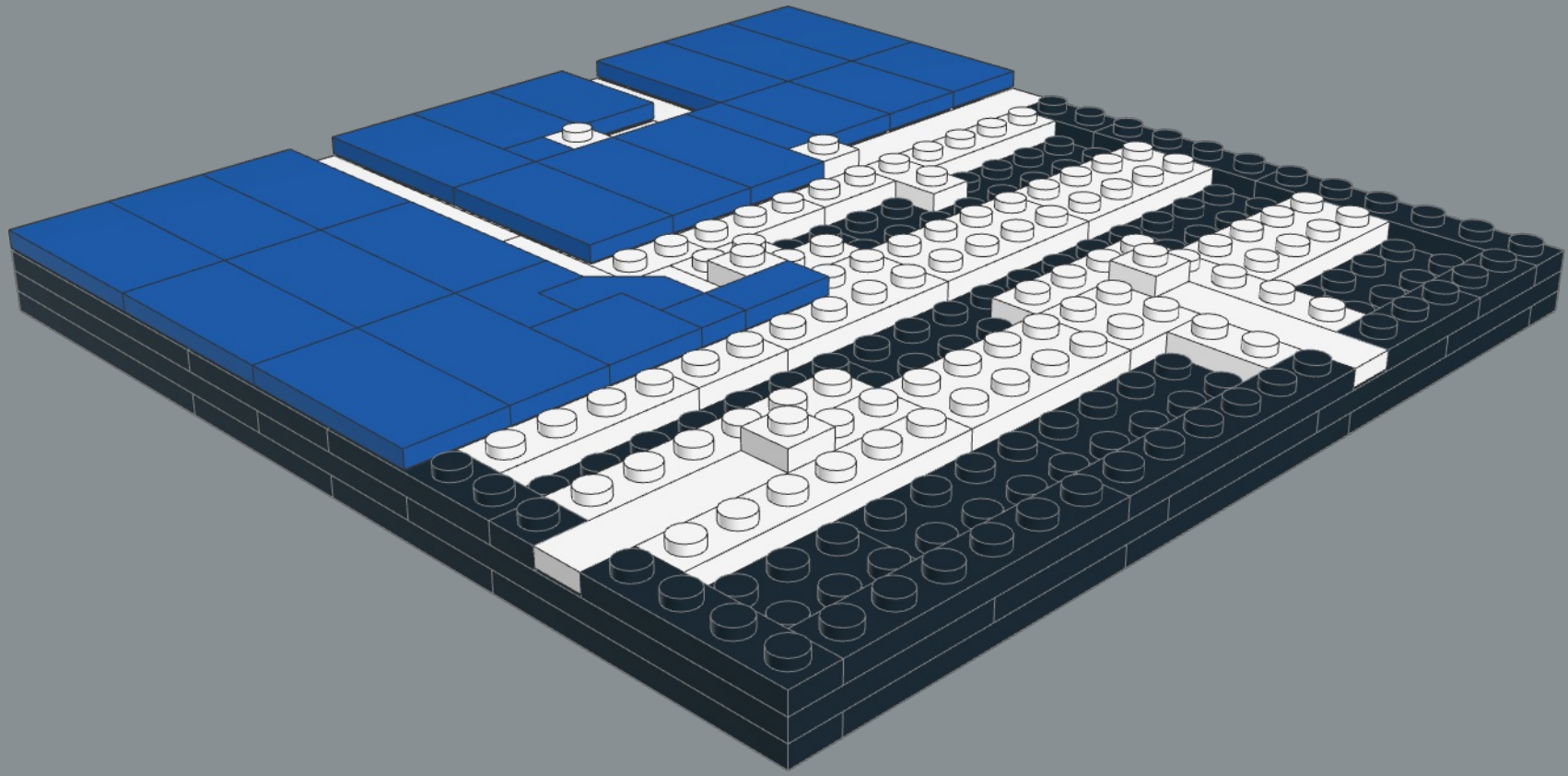
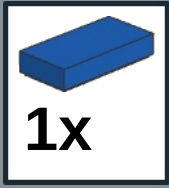

61

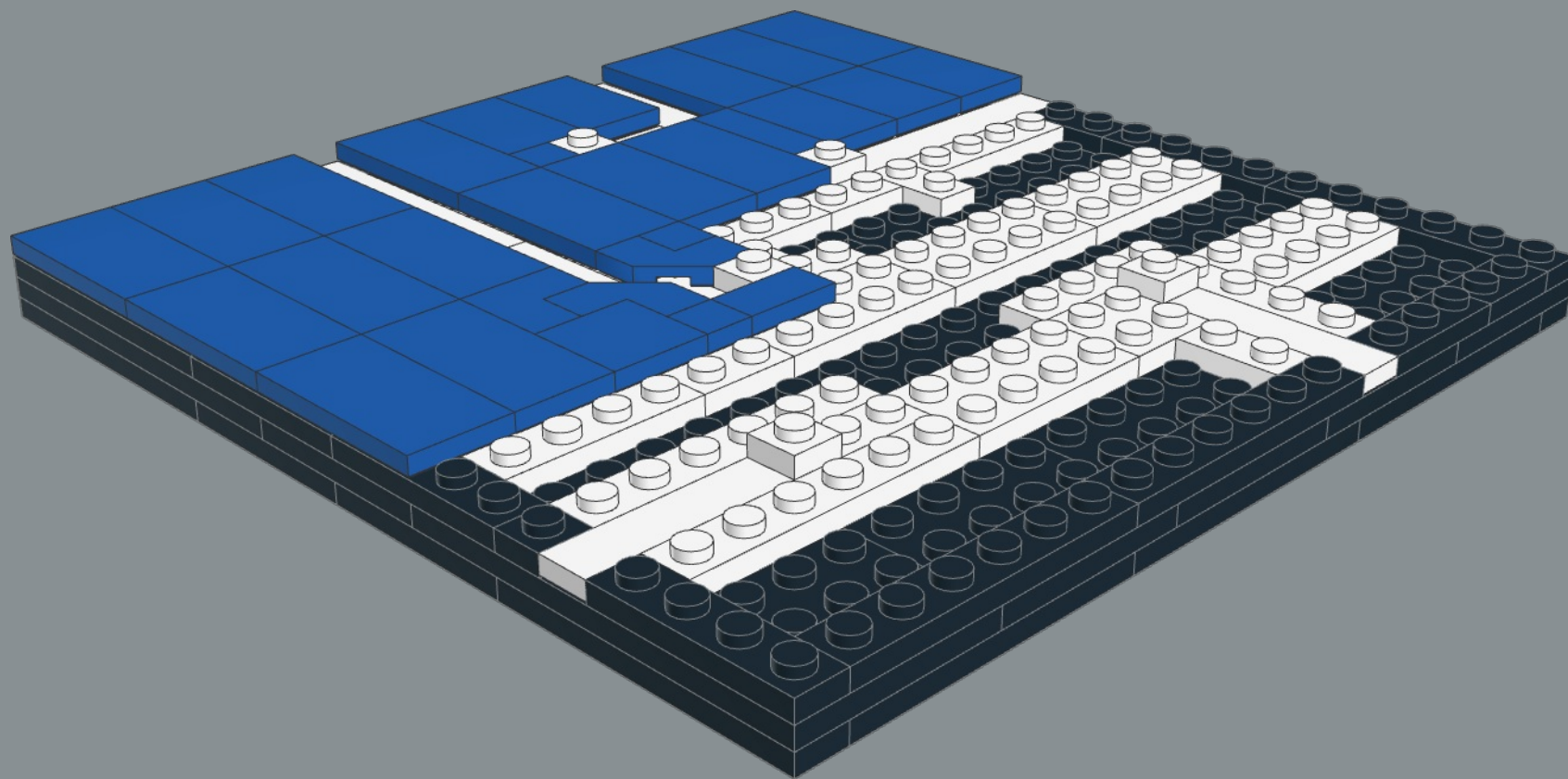
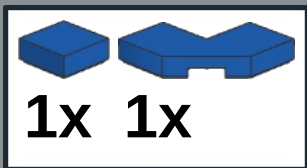

62

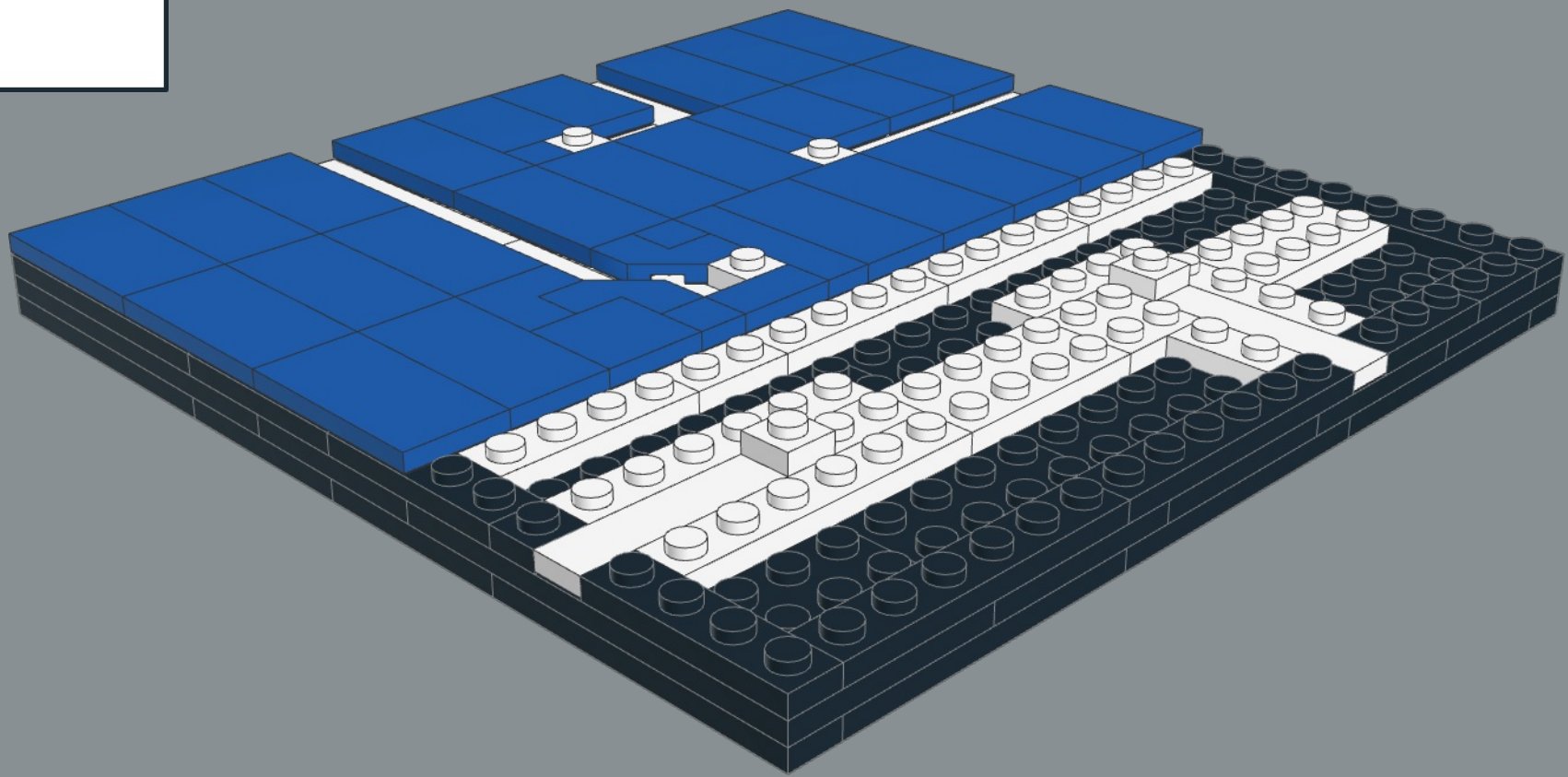
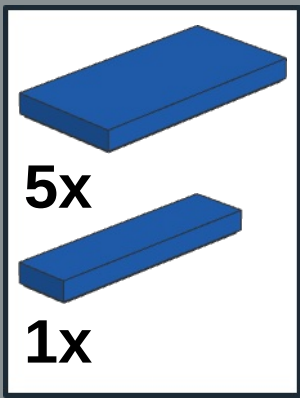

63

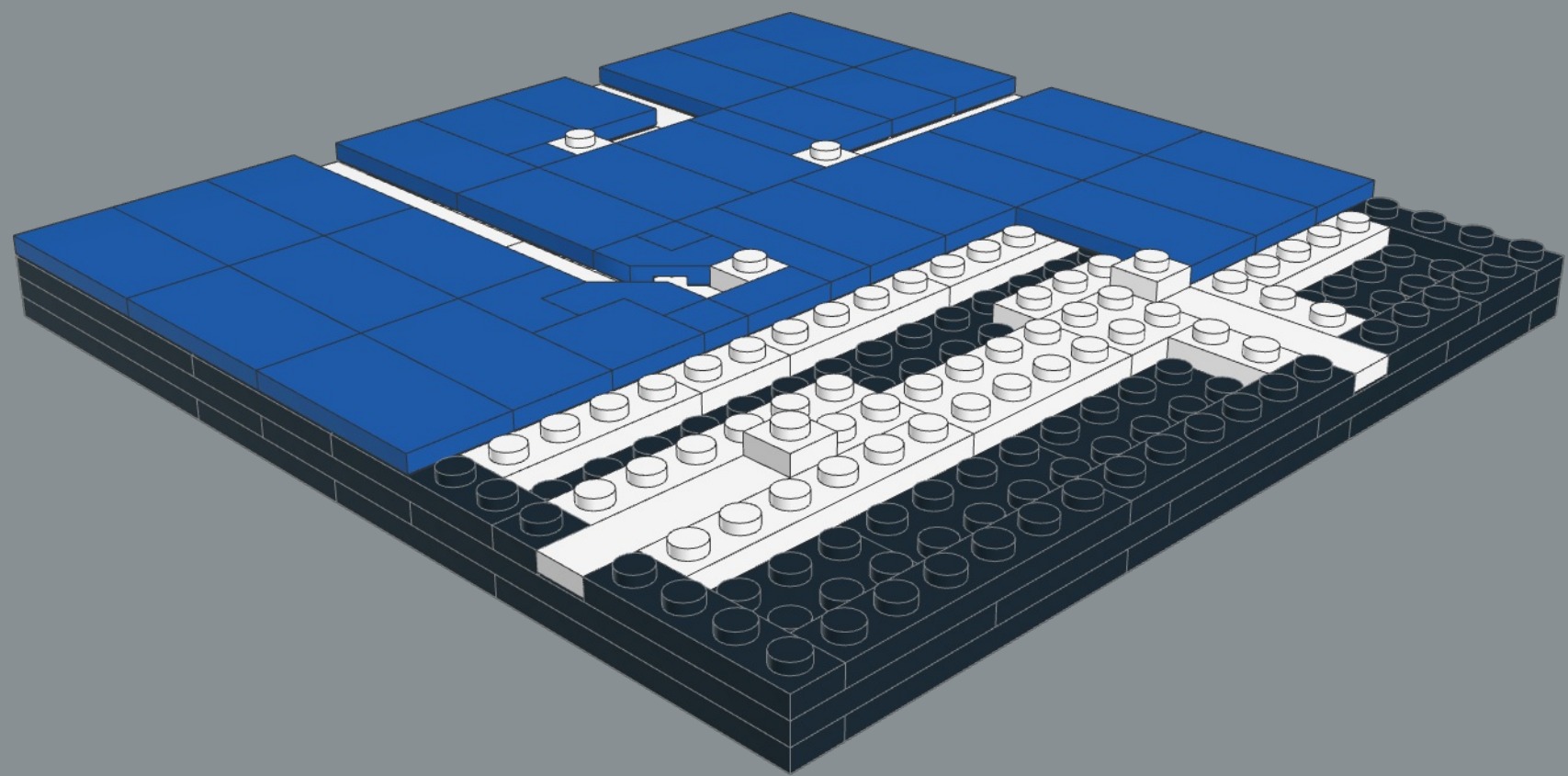
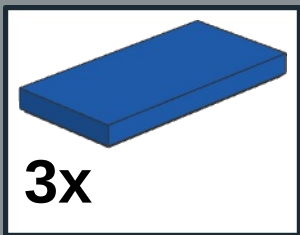

64

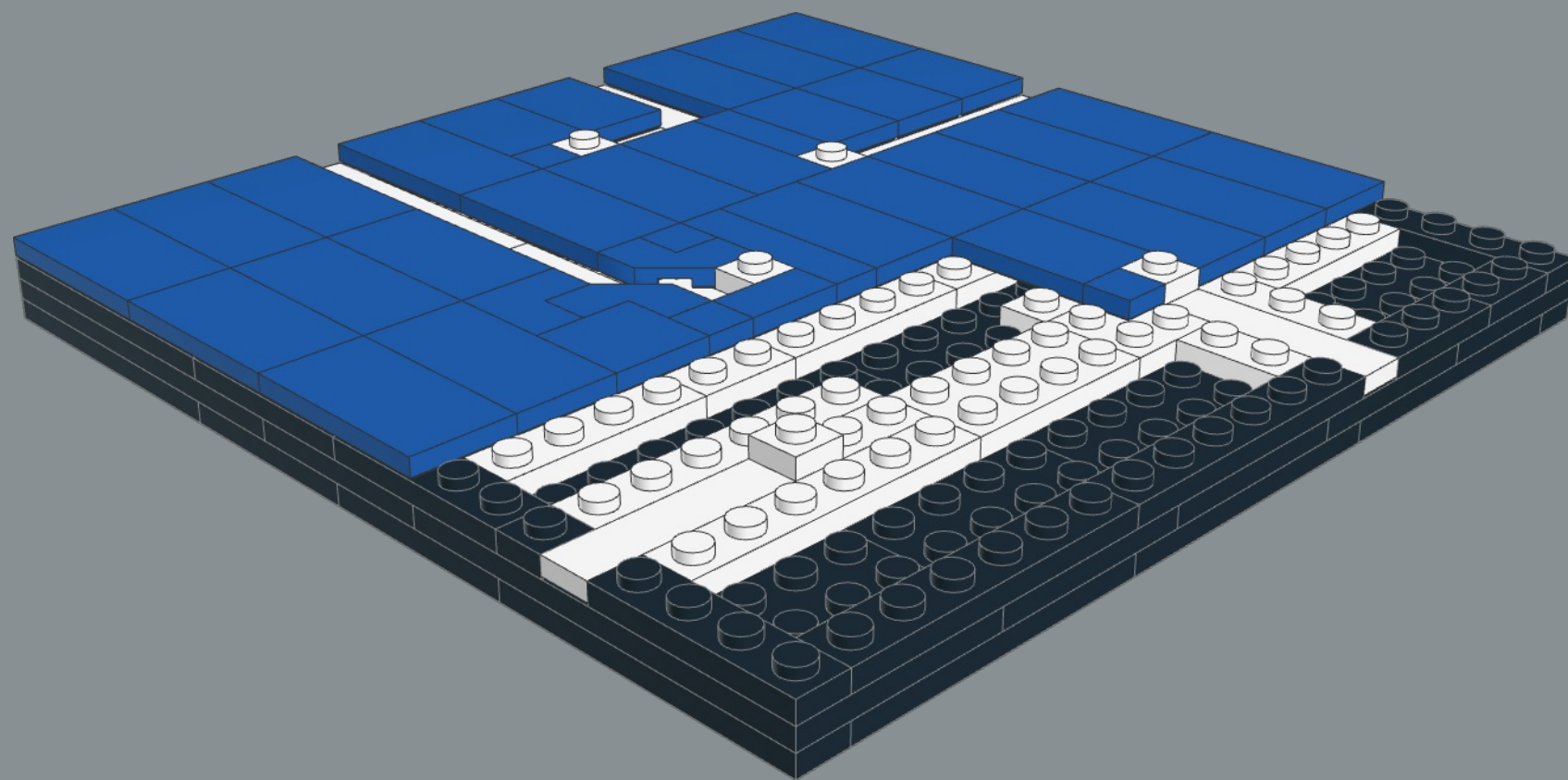
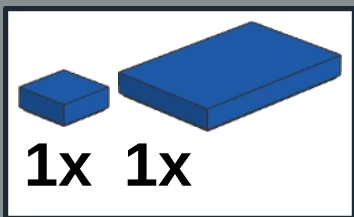

65

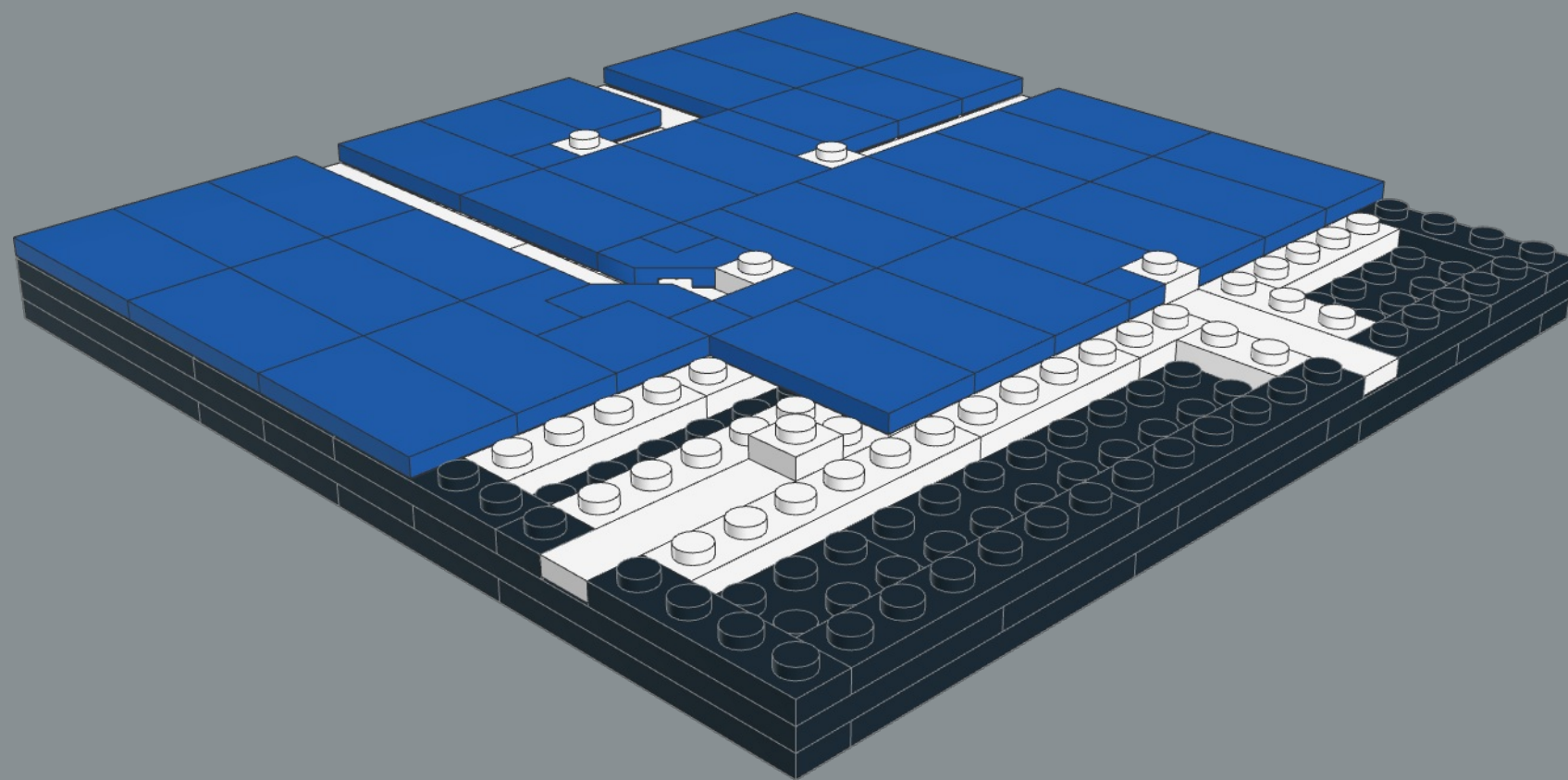
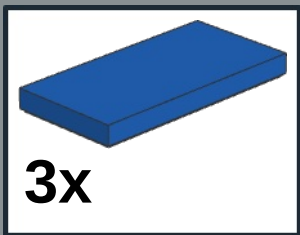

66

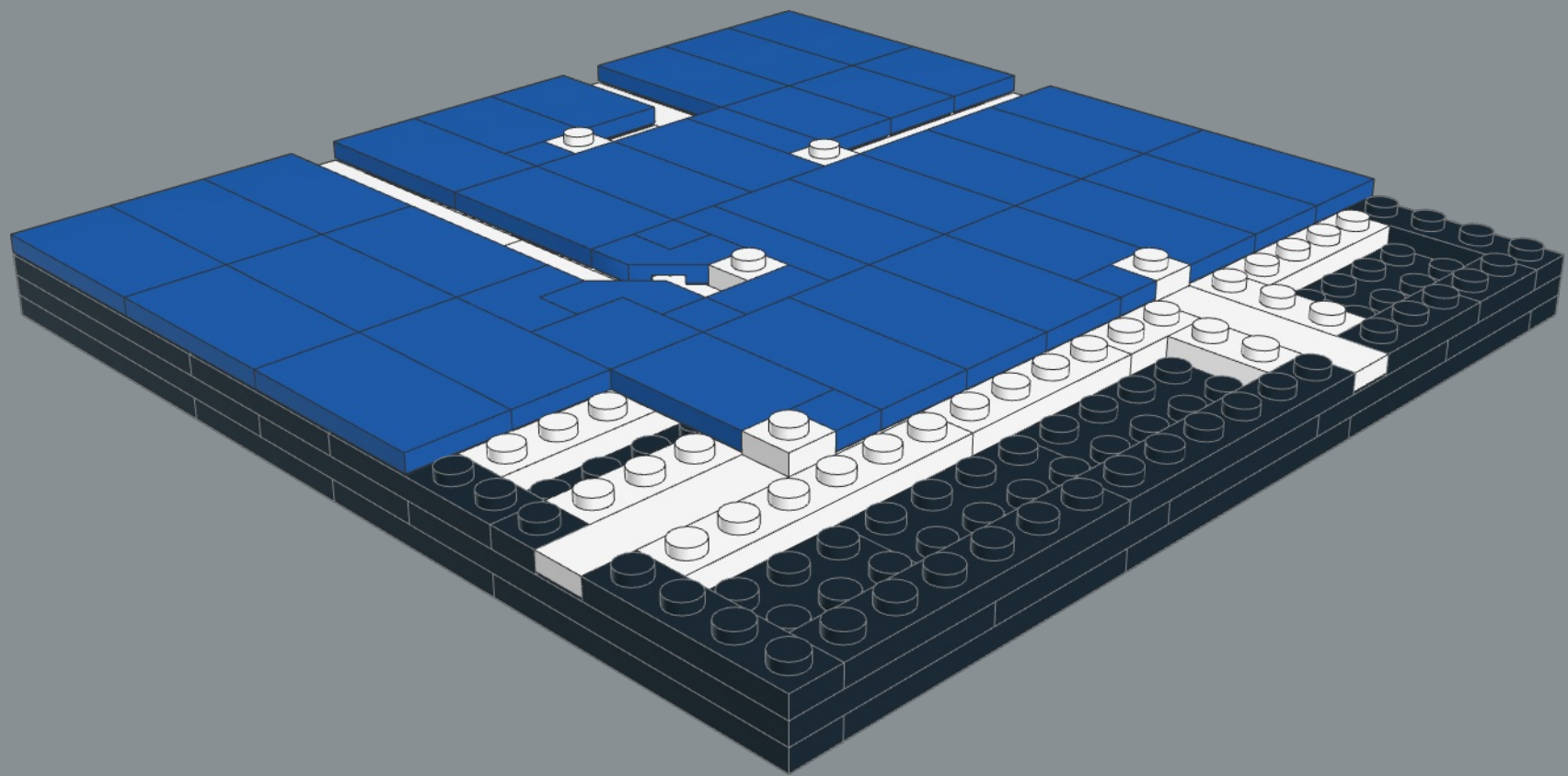
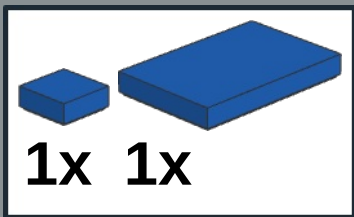

67

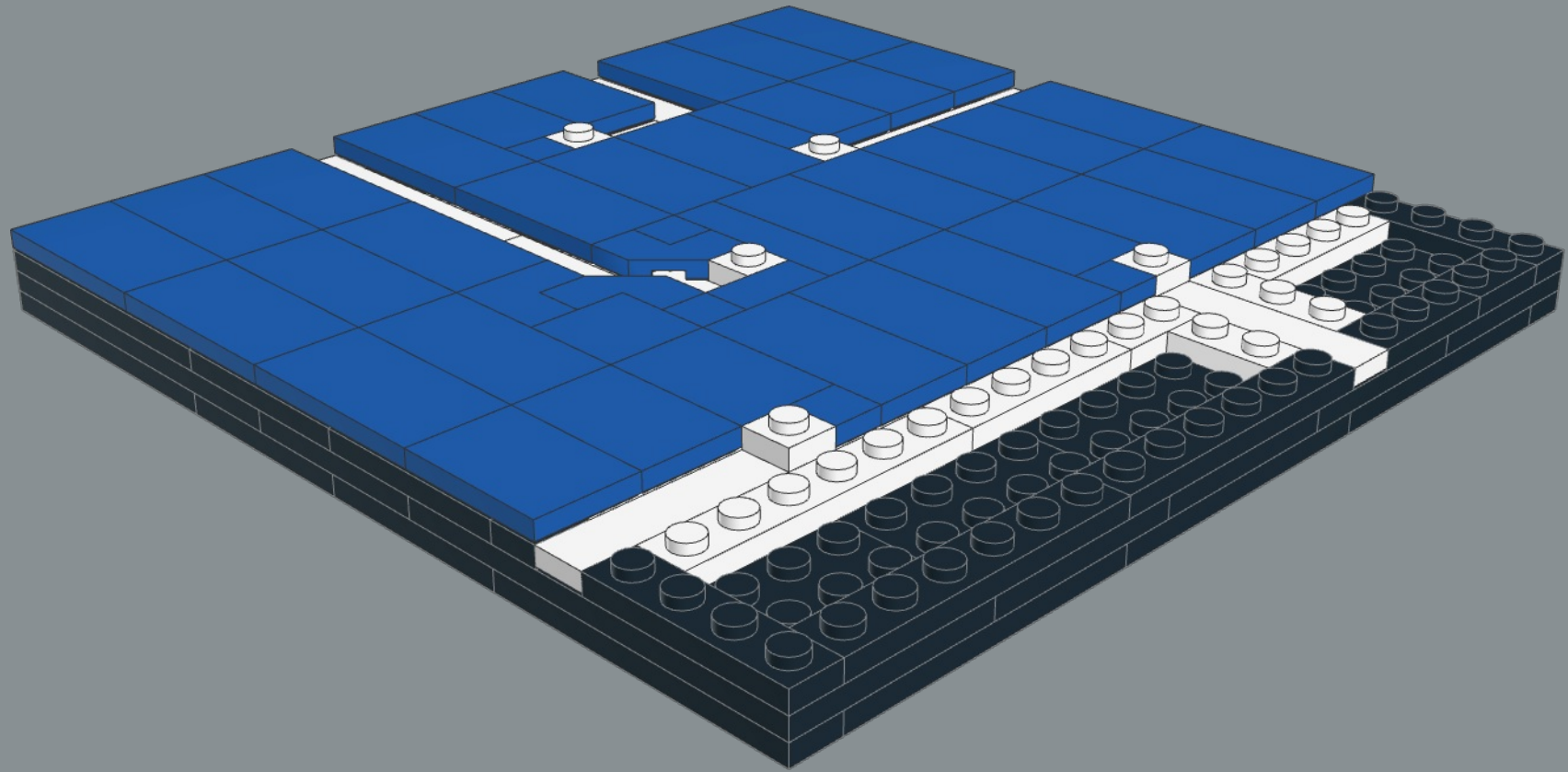
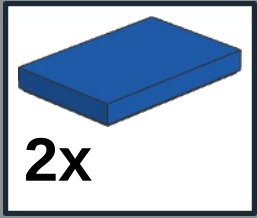

68

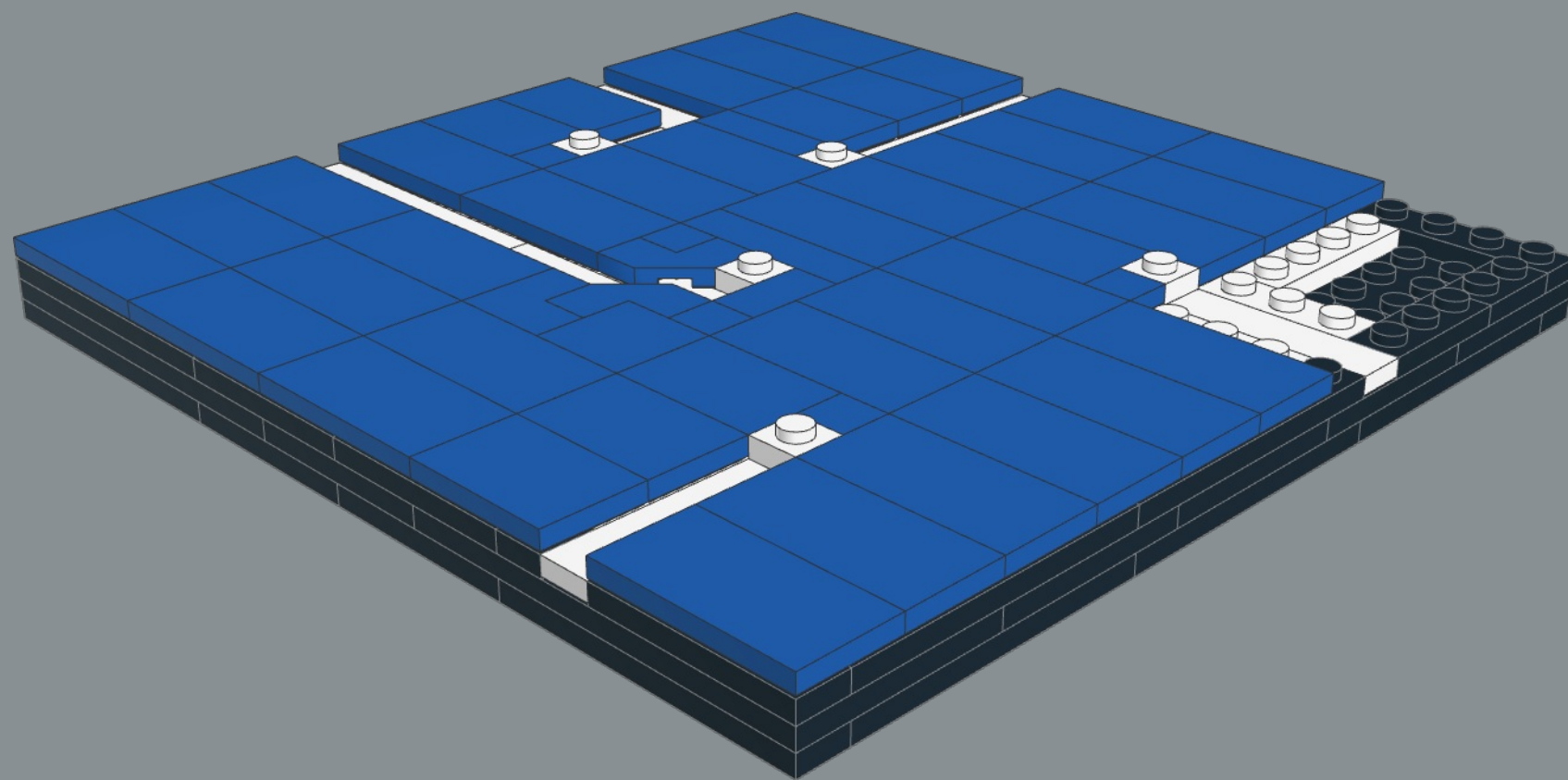
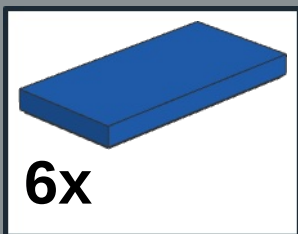

69

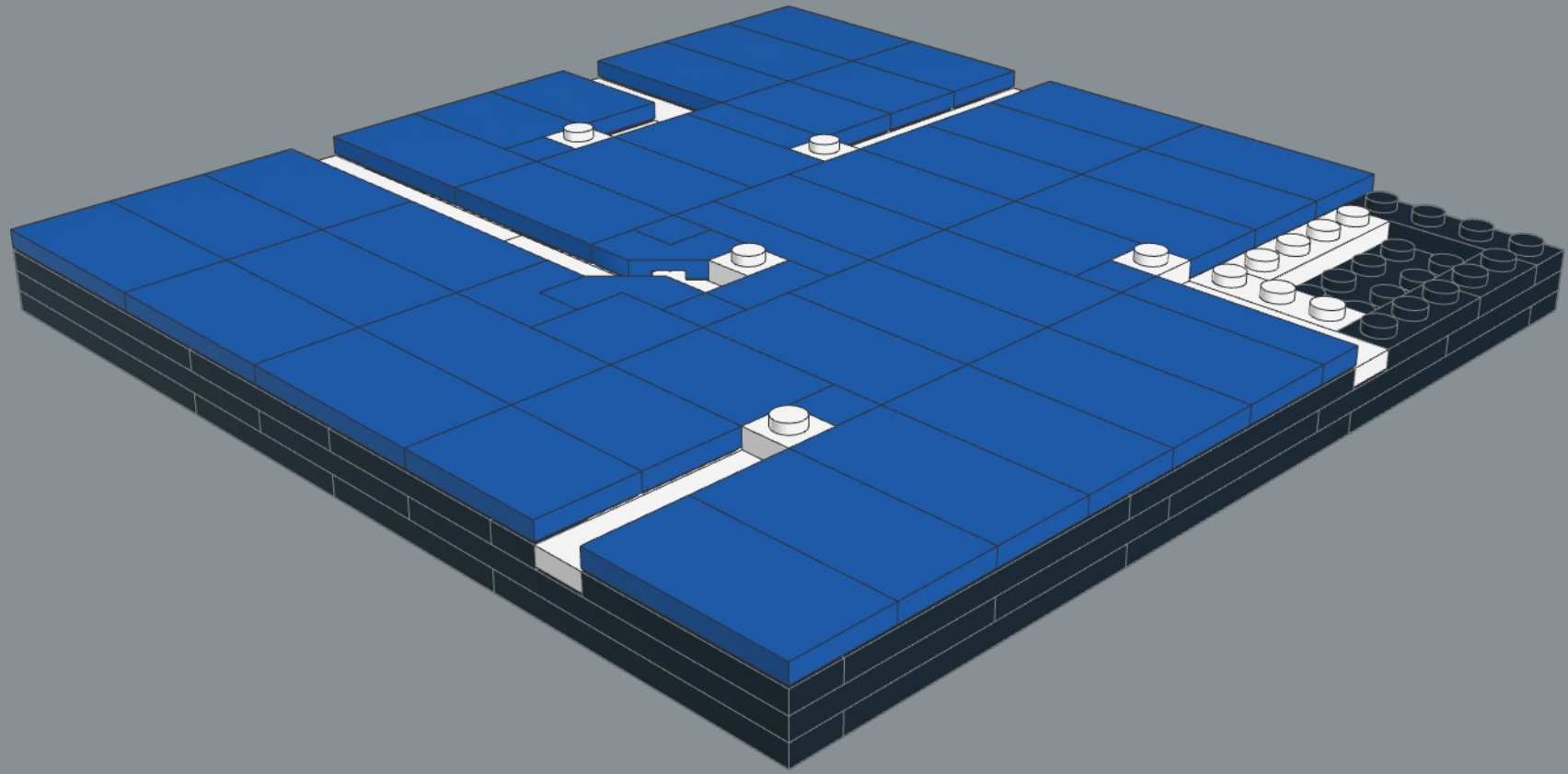
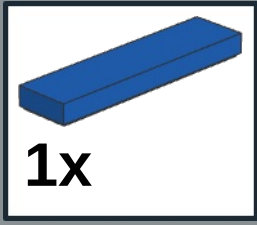

70

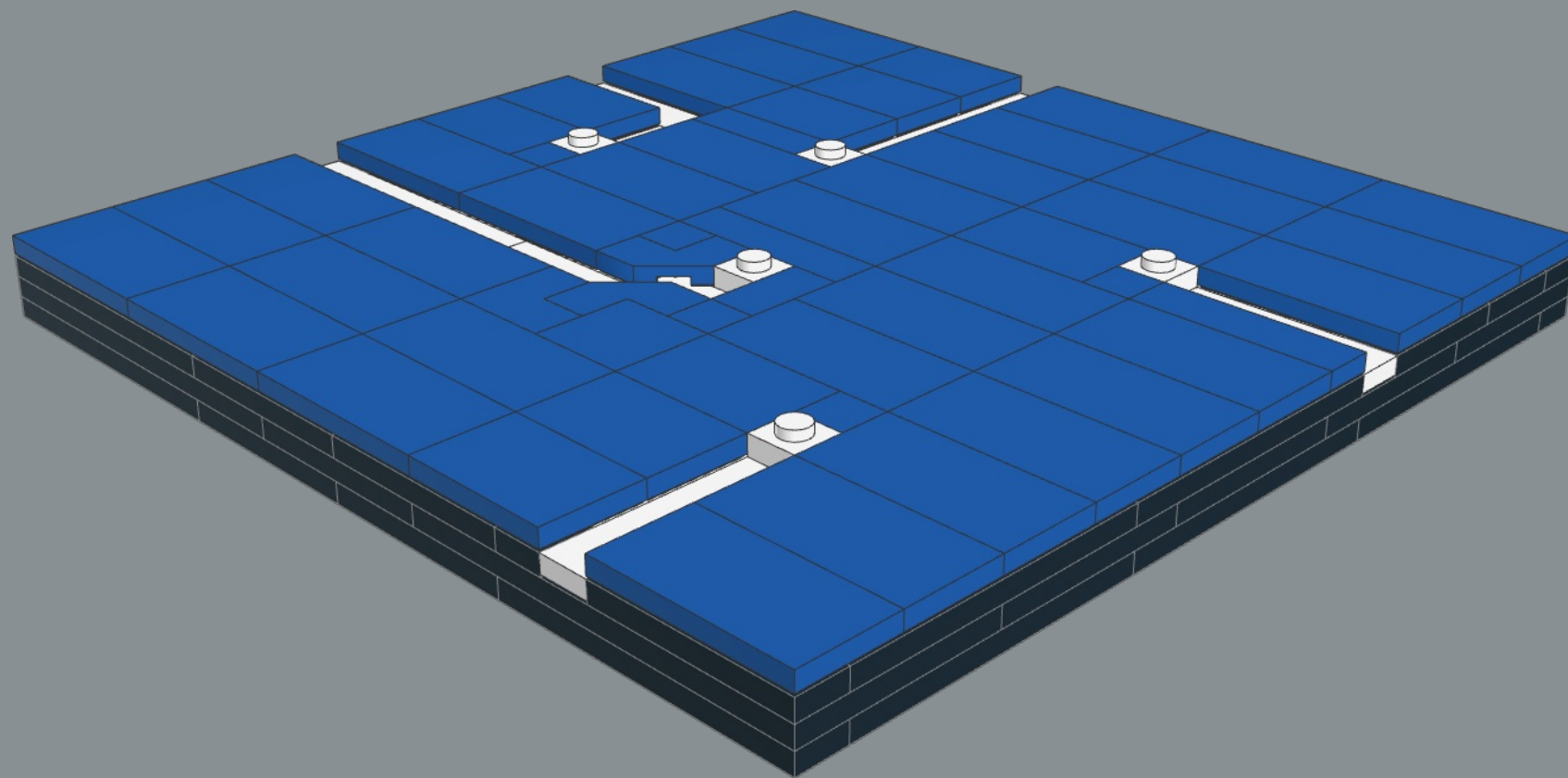
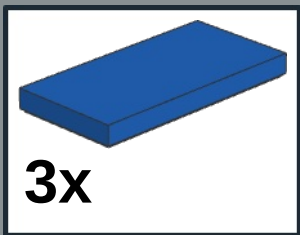

71

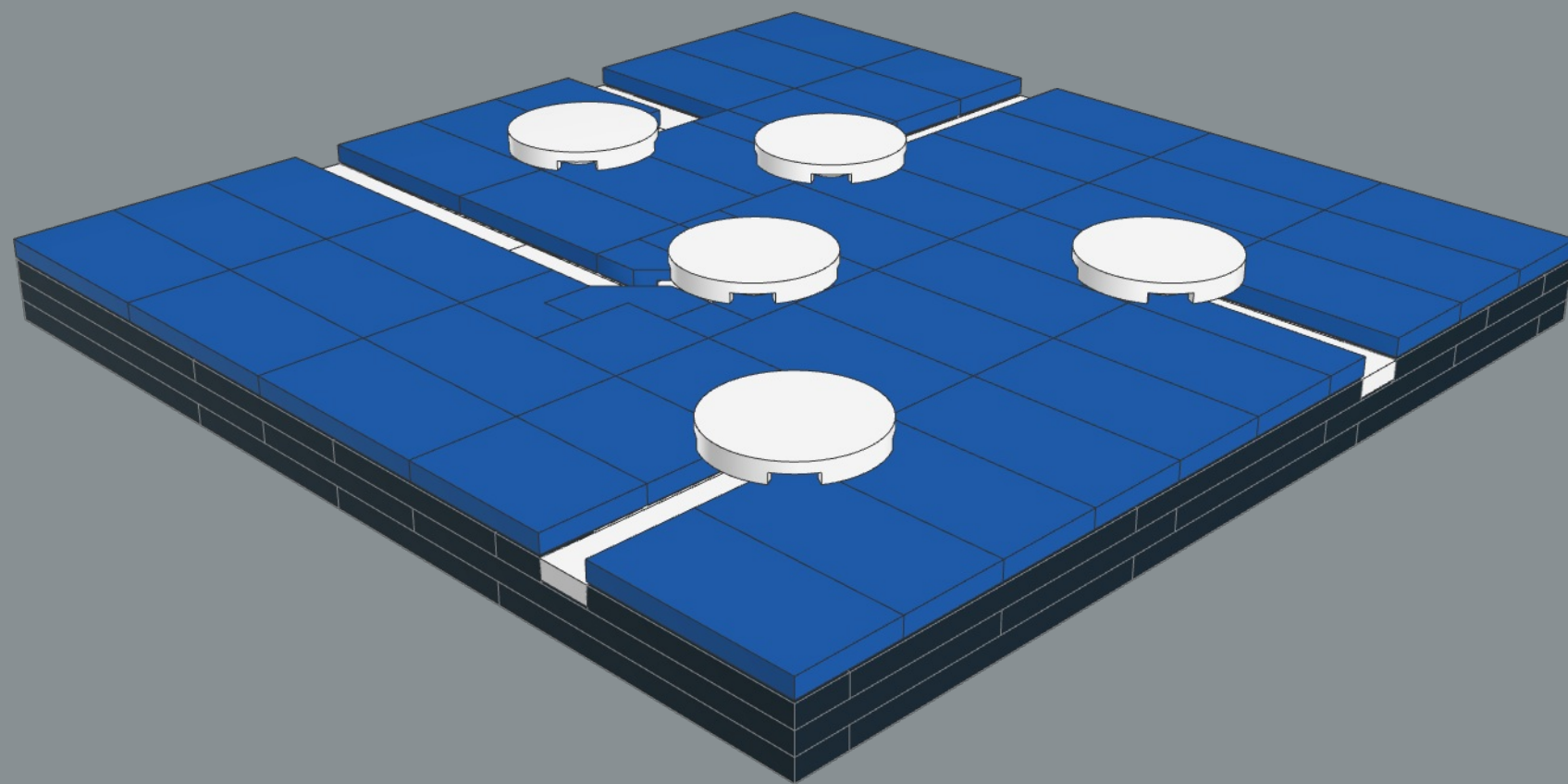
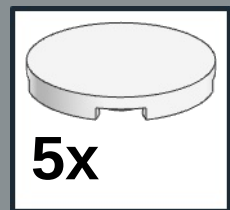

Honorable mentions of contributors:

Teg12345

dalesr

csscg

Hope you had fun with this model and instructions.
As always you can reach out to me via email:

birdbrickbuilds@gmail.com

You can also check my work on rebrickable and
instagram:

<https://rebrickable.com/users/birdbrickbuilds/>

<https://www.instagram.com/birdbrickbuilds/>

If you wish to help me continue to make this
models and instructions you can buy me a coffee
to help me stay up late:

<https://www.buymeacoffee.com/birdbrickbl>

Or you can buy my Coffee Espresso MOC:

<https://reb.li/m/118798>



This work is licensed under a [Creative Commons Attribution-NonCommercial-ShareAlike 4.0 International License](https://creativecommons.org/licenses/by-nc-sa/4.0/).