

PACMAN

82 PARTS

PACMAN

MODEL INSTRUCTIONS BY
BIRD BRICK BUILDS

AUTHOR: EDUARDO SOUSA



PACMAN

PACMAN: A TIMELESS ARCADE ADVENTURE

PAC-MAN IS A CLASSIC ARCADE GAME THAT HAS LEFT AN INDELIBLE MARK ON THE GAMING WORLD. CREATED BY JAPANESE VIDEO GAME DESIGNER TORU IWATANI, PAC-MAN WAS FIRST RELEASED BY NAMCO IN 1980. THE GAME QUICKLY BECAME A CULTURAL PHENOMENON AND AN ICONIC SYMBOL OF THE GAMING INDUSTRY.

PAC-MAN, THE TITULAR CHARACTER, IS A YELLOW, CIRCULAR CREATURE WITH A VORACIOUS APPETITE FOR PELLETS. THE GAME IS SET IN A MAZE, AND THE PLAYER CONTROLS PAC-MAN AS HE NAVIGATES THE LABYRINTH, MUNCHING ON PELLETS WHILE AVOIDING GHOSTS NAMED BLINKY, PINKY, INKY, AND CLYDE. THE GOAL IS TO CLEAR THE MAZE OF ALL PELLETS WHILE EVAIDING THE RELENTLESS PURSUIT OF THE GHOSTS.

TORU IWATANI, THE MASTERMIND BEHIND PAC-MAN, WAS INSPIRED TO CREATE A GAME THAT WOULD APPEAL TO WOMEN AND COUPLES. HE ENVISIONED A GAME THAT WAS NOT ONLY CHALLENGING BUT ALSO CUTE AND FRIENDLY. IN AN INTERVIEW, IWATANI EXPLAINED HIS INSPIRATION, SAYING:

"ALL THE COMPUTER GAMES AVAILABLE AT THE TIME WERE OF THE VIOLENT TYPE - WAR GAMES AND SPACE INVADER TYPES. THERE WERE NO GAMES THAT EVERYONE COULD ENJOY, AND ESPECIALLY NONE FOR WOMEN. I WANTED TO COME UP WITH A "COMICAL" GAME WOMEN COULD ENJOY."

- TORU IWATANI, PAC-MAN CREATOR

THIS LED TO THE CREATION OF PAC-MAN, A CHARACTER THAT EXUDES CHARM AND SIMPLICITY.





Attribution-NonCommercial-ShareAlike 4.0 International (CC BY-NC-SA 4.0)

This is a human-readable summary of (and not a substitute for) the [full license](#).

You are free to:

Share — copy and redistribute the material in any medium or format

Adapt — remix, transform, and build upon the material

The licensor cannot revoke these freedoms as long as you follow the license terms.

Under the following terms:



Attribution — You must give [appropriate credit](#), provide a link to the license, and [indicate if changes were made](#). You may do so in any reasonable manner, but not in any way that suggests the licensor endorses you or your use.



NonCommercial — You may not use the material for [commercial purposes](#).



ShareAlike — If you remix, transform, or build upon the material, you must distribute your contributions under the [same license](#) as the original.

No additional restrictions — You may not apply legal terms or [technological measures](#) that legally restrict others from doing anything the license permits.

Notices:

You do not have to comply with the license for elements of the material in the public domain or where your use is permitted by an applicable [exception or limitation](#).

No warranties are given. The licensor may not give you all of the permissions necessary for your intended use. For example, other rights such as [patents, publicity, privacy, or moral rights](#) may limit how you use the material.



Hope you have fun with this model and instructions.
As always you can reach out to me via email:

birdbrickbuilds@gmail.com

If you wish to help me continue to make this
models and instructions you can buy me a coffee
to help me stay up late:

<https://www.buymeacoffee.com/birdbrickbl>

You can also check my work on rebrickable and
instagram:

<https://rebrickable.com/users/birdbrickbuilds/>
<https://www.instagram.com/birdbrickbuilds/>

Or you can buy my Coffee Espresso MOC:

<https://reb.li/m/118798>

Or even you can buy my Beer Mug MOC:

<https://reb.li/m/137364>



This work is licensed under a [Creative Commons Attribution-NonCommercial-ShareAlike 4.0 International License](https://creativecommons.org/licenses/by-nc-sa/4.0/).

1

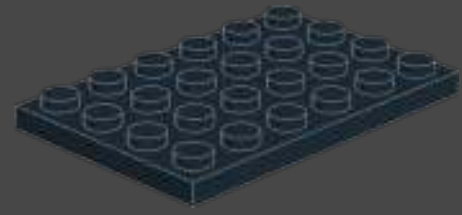
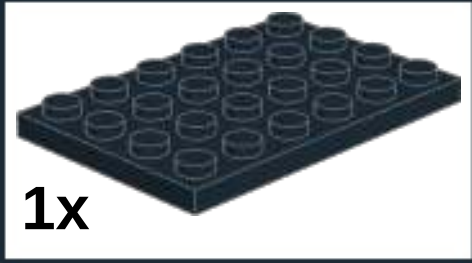

2

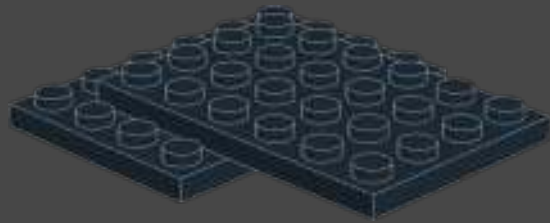

3

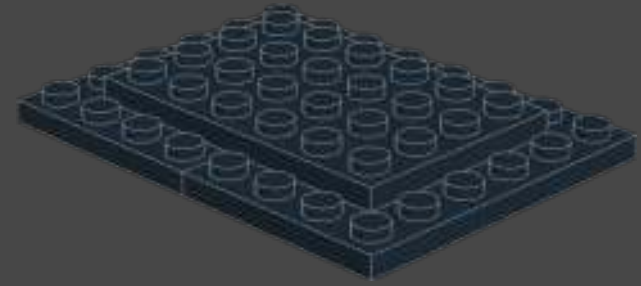
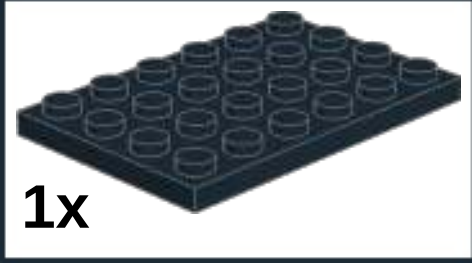

4

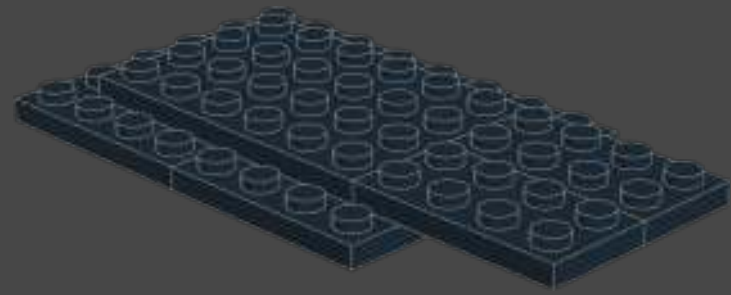
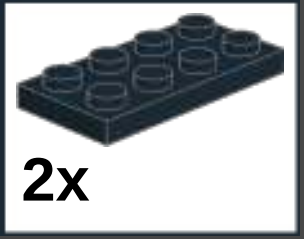

5

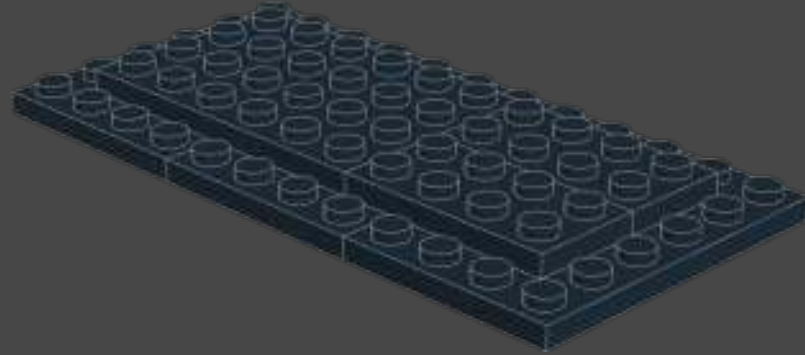

6

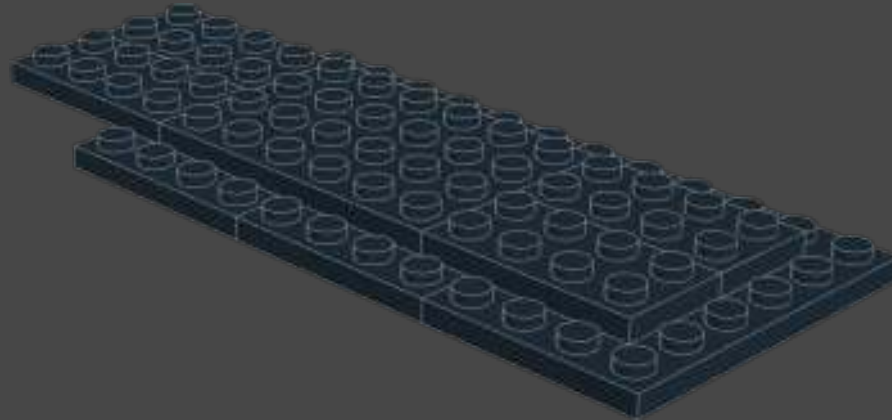
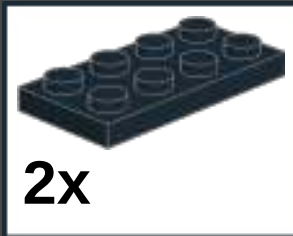

7

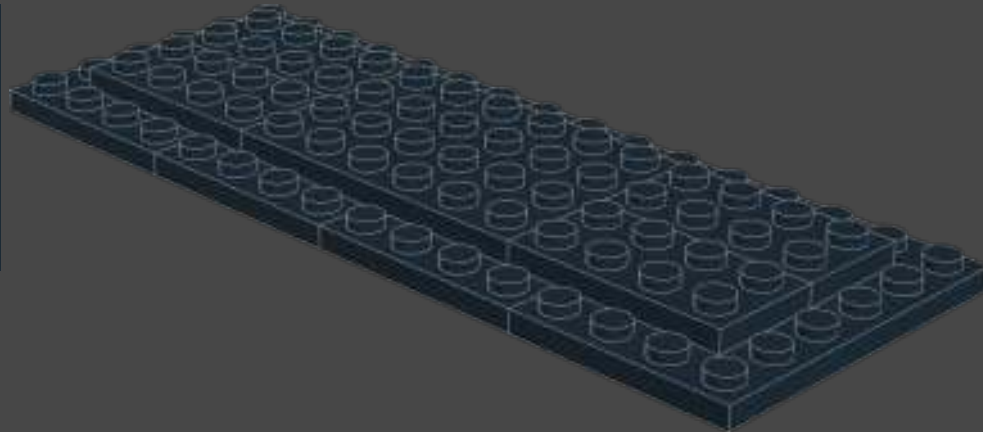
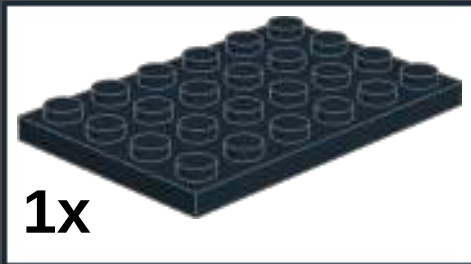

8

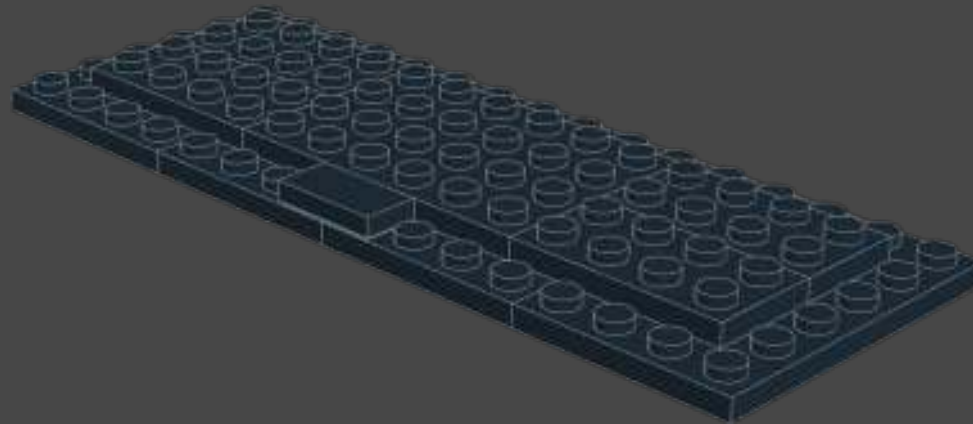

9

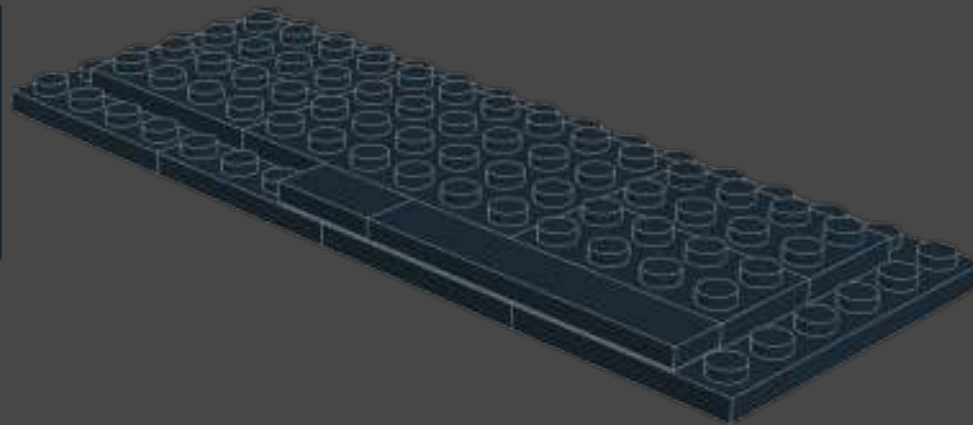

10

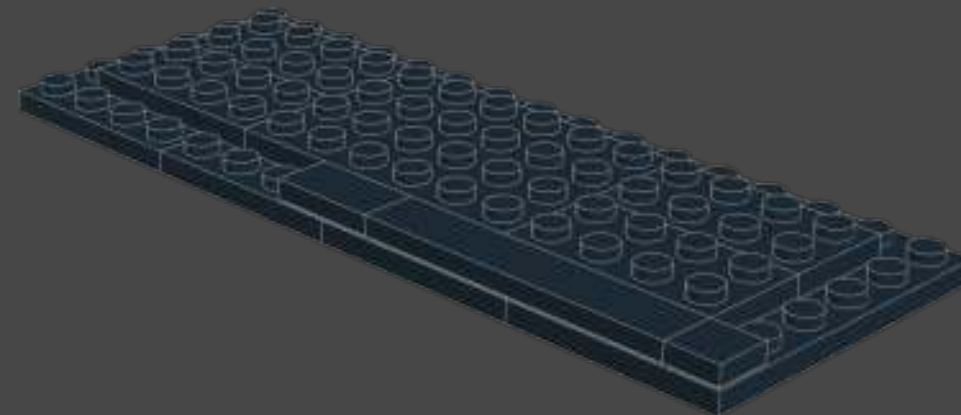

11

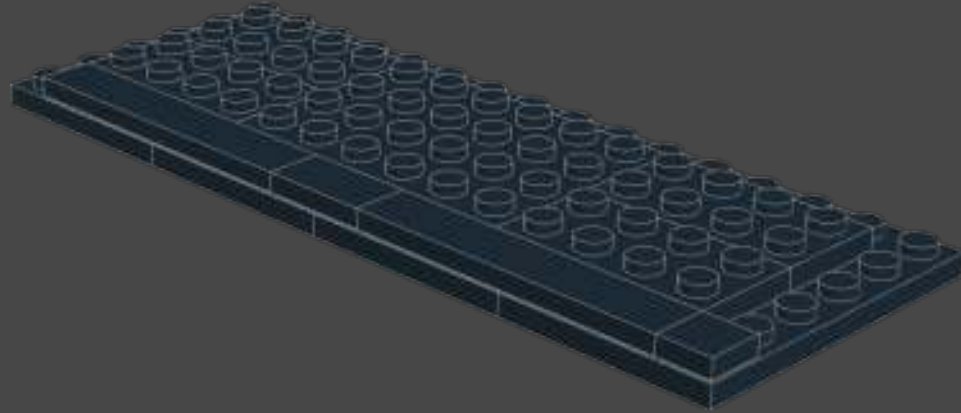

12

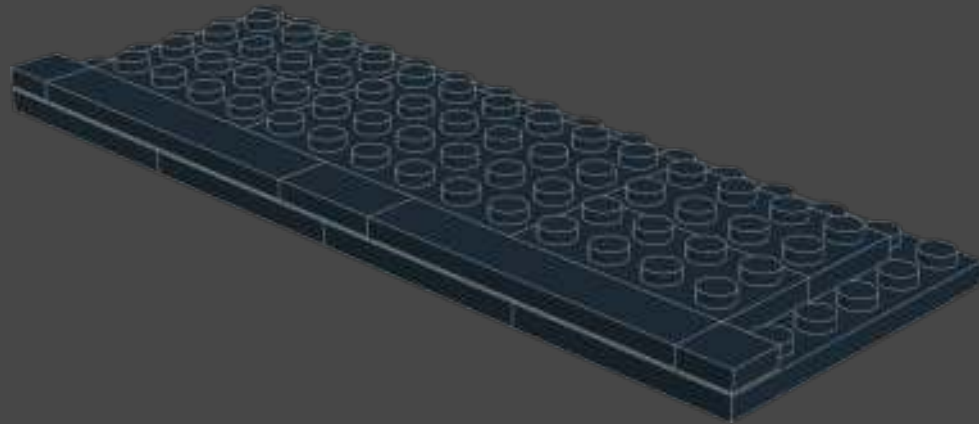

13

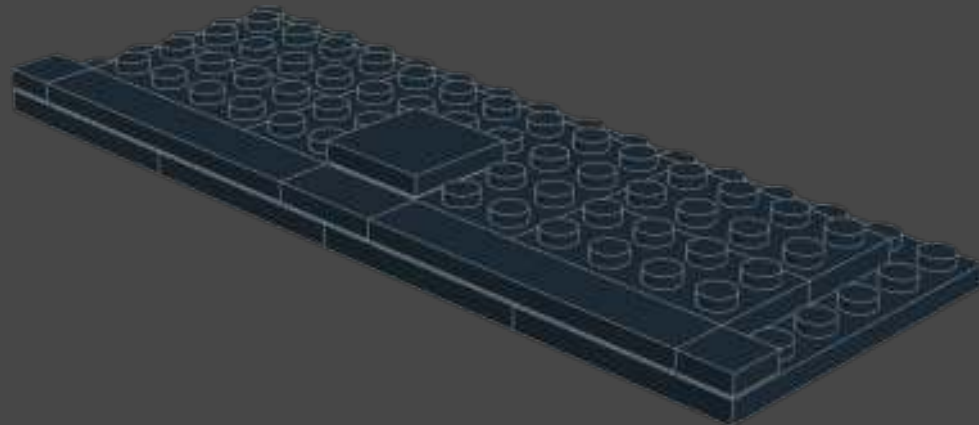
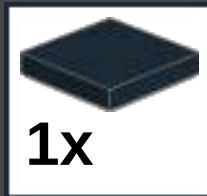

14



1x



1x

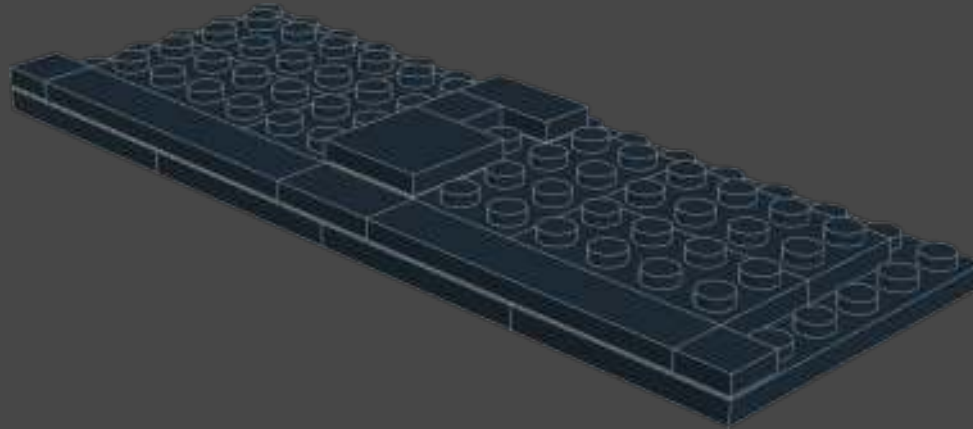

15



1x

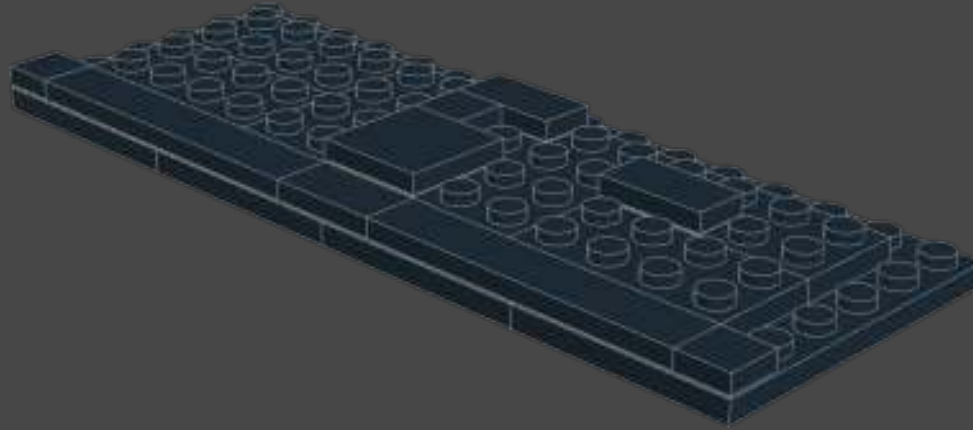

16



1x



1x

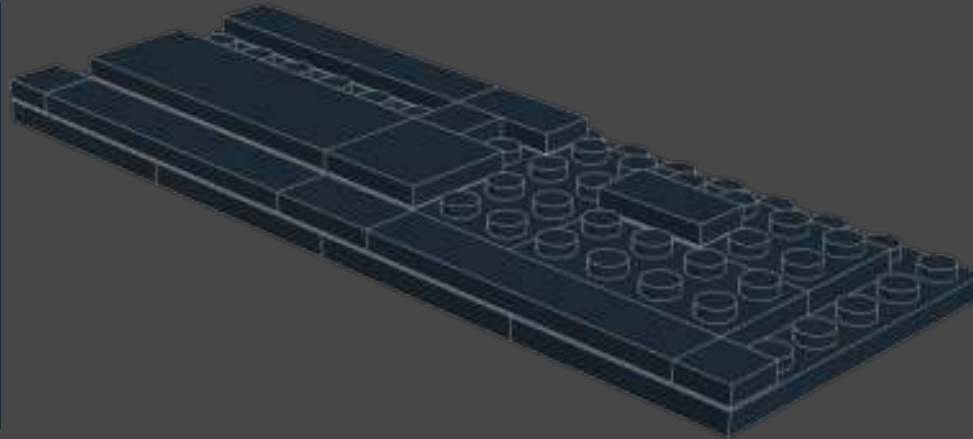

17

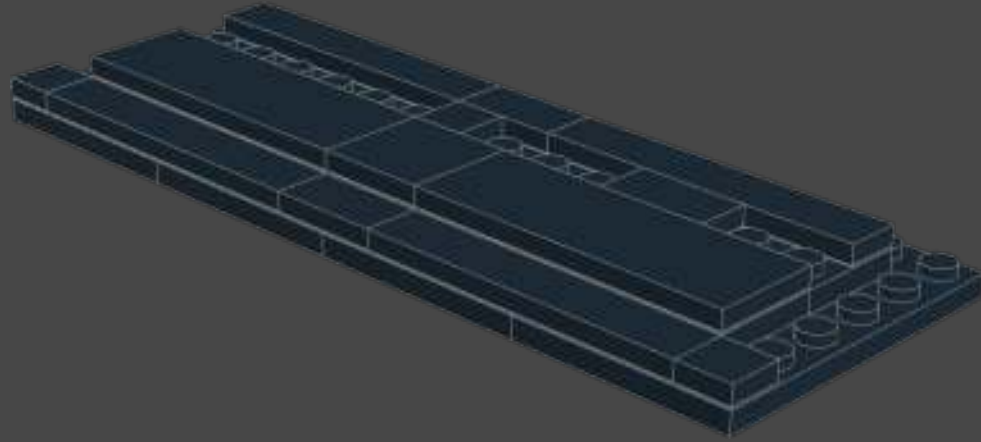
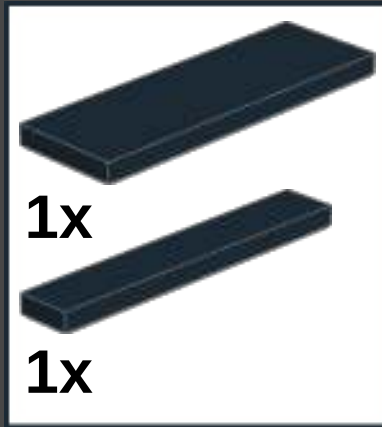

18

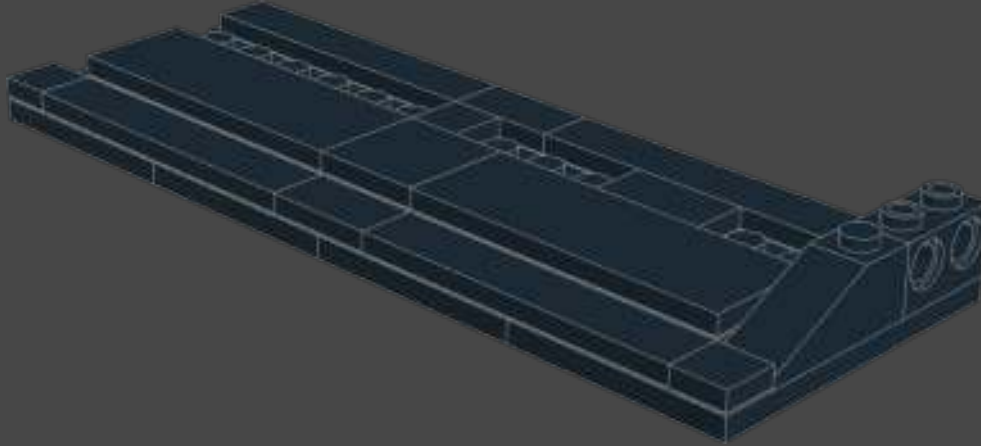
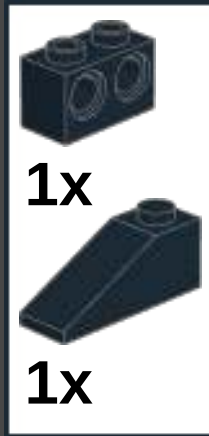

19

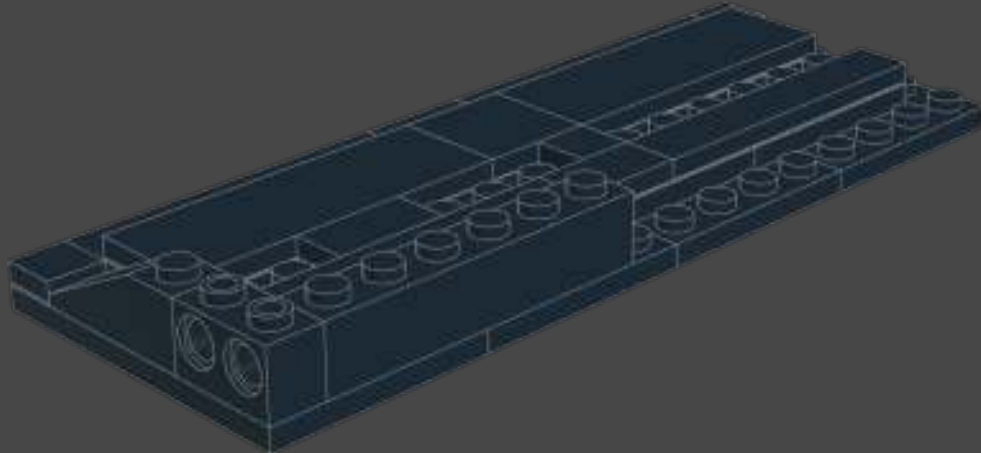
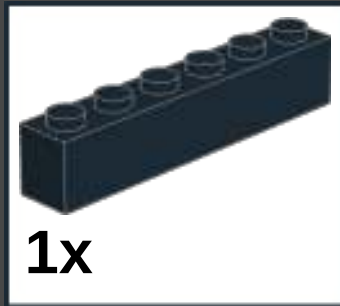

20

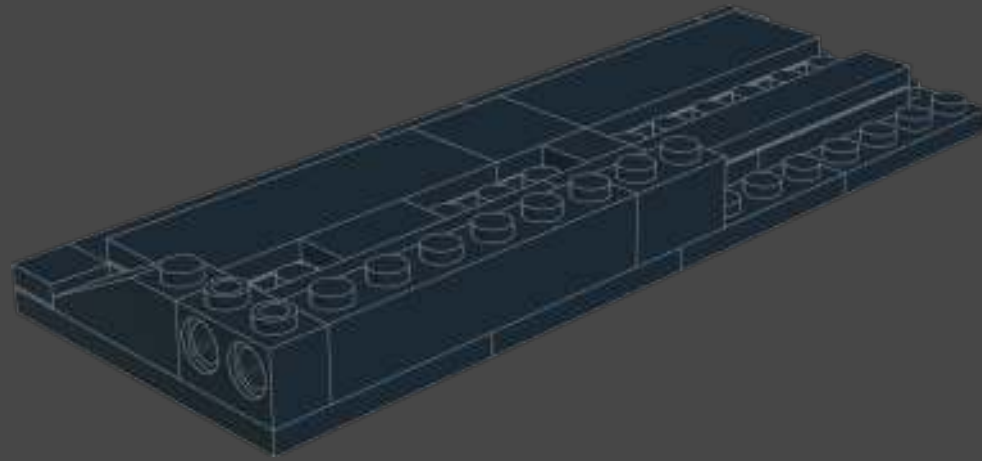

21

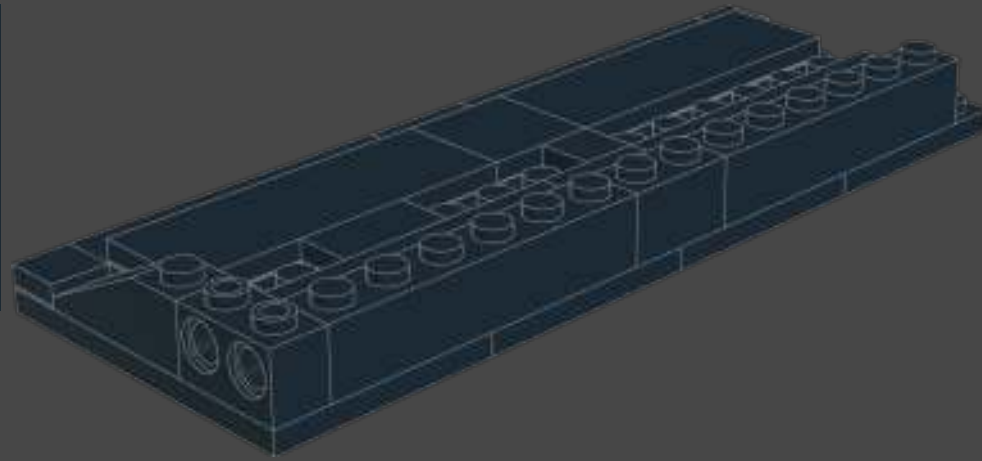
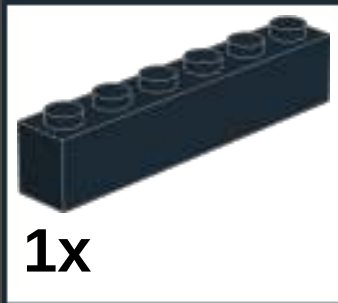

22

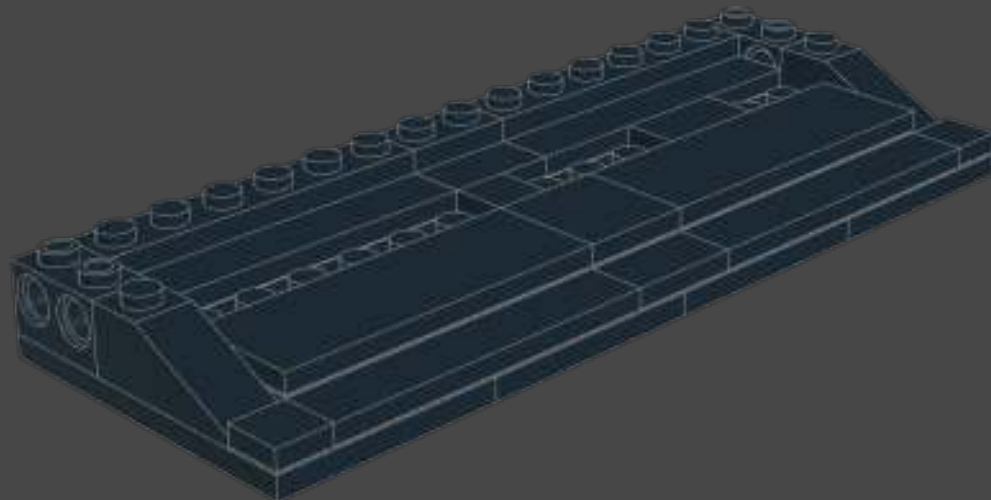
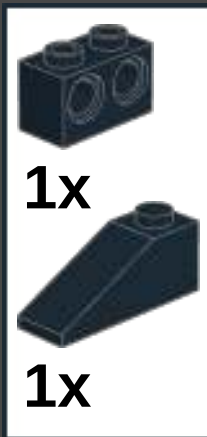

23



1x

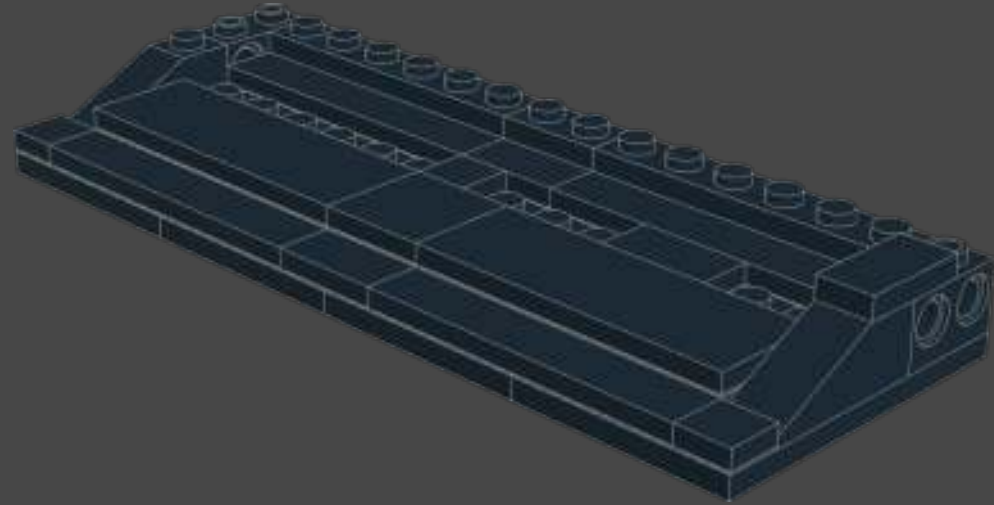

24



1x

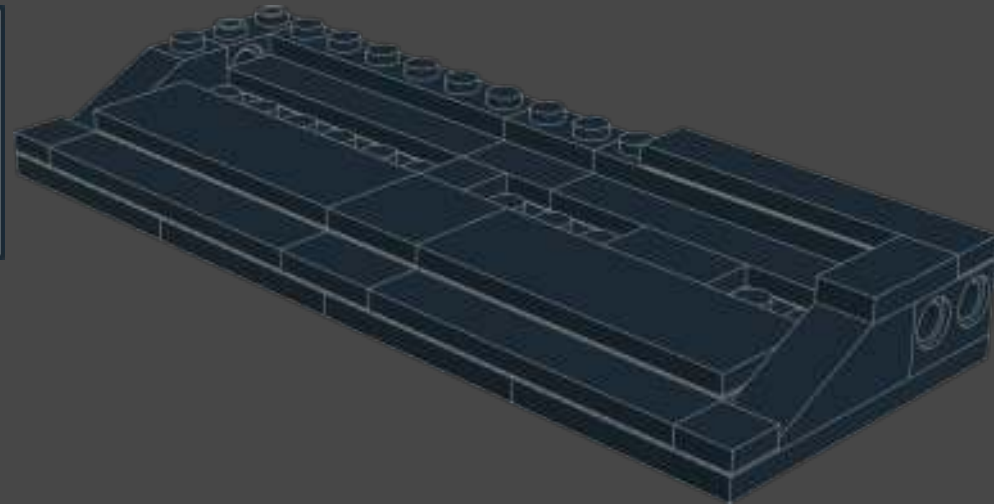

25

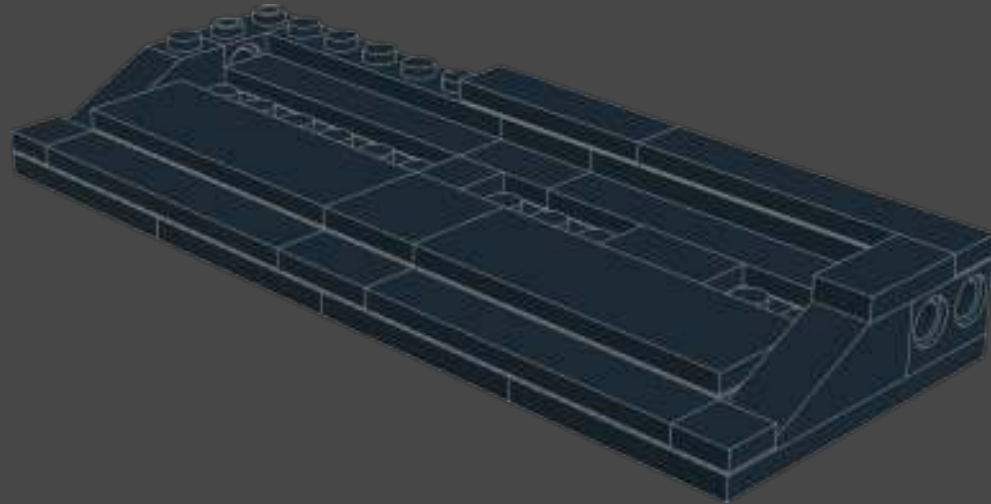
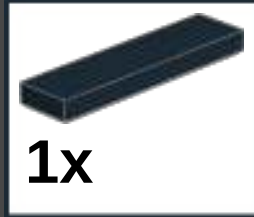

26

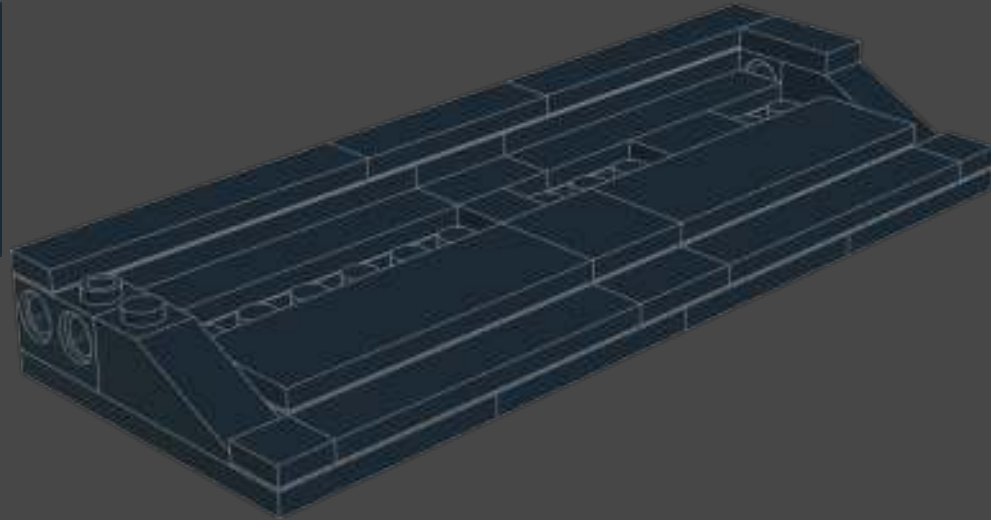

27



1x

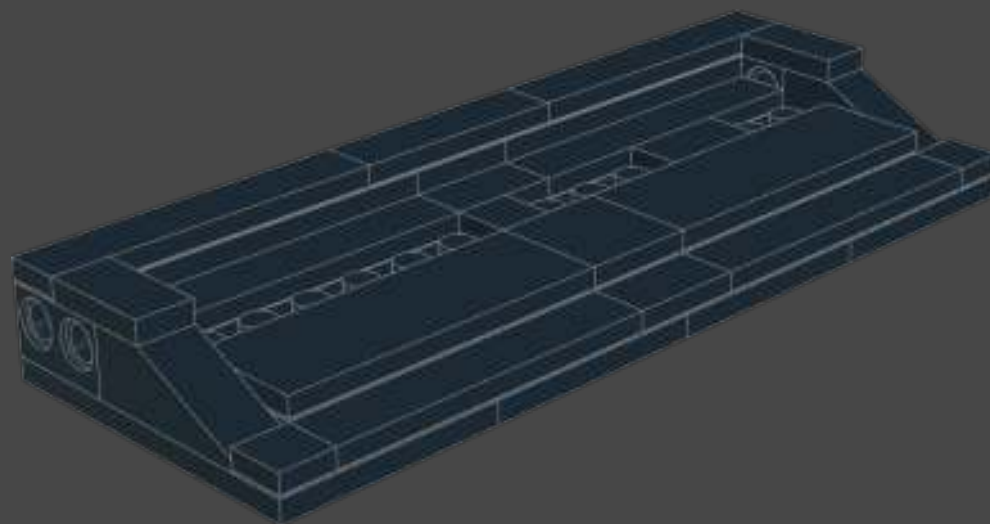

1

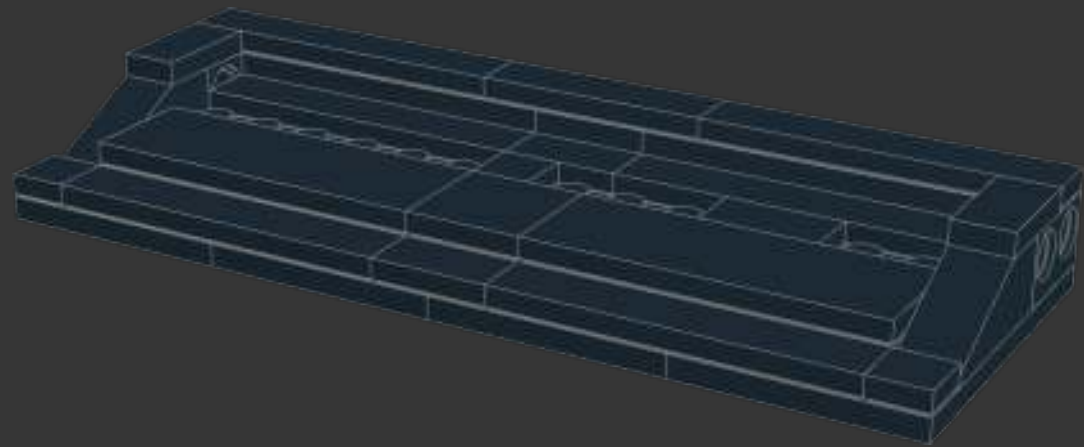

2
1x

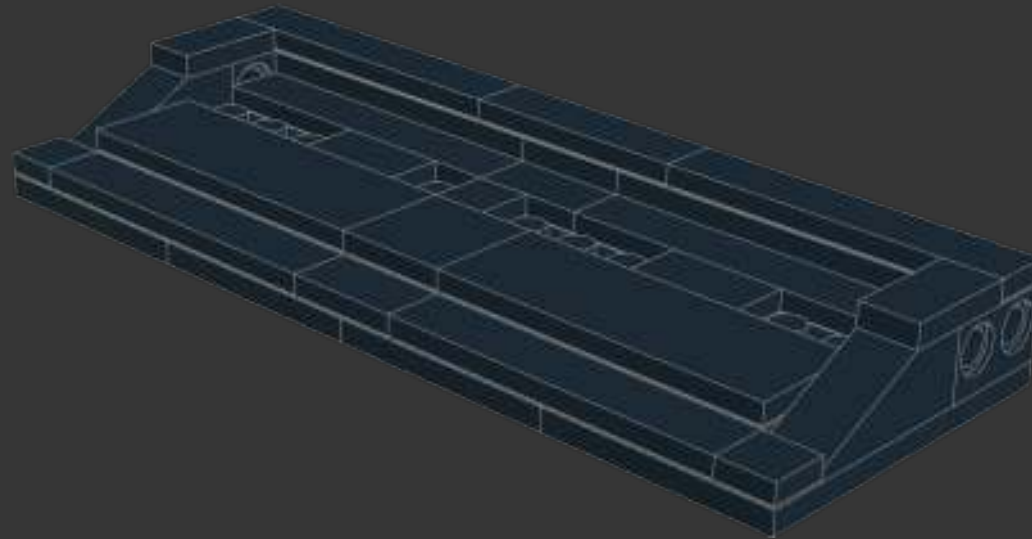

3
1x

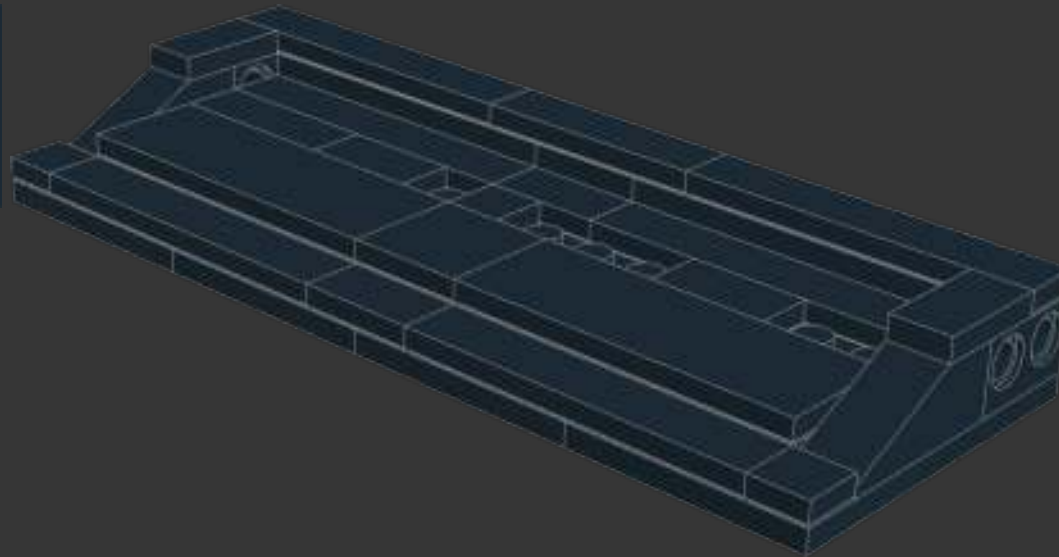

4

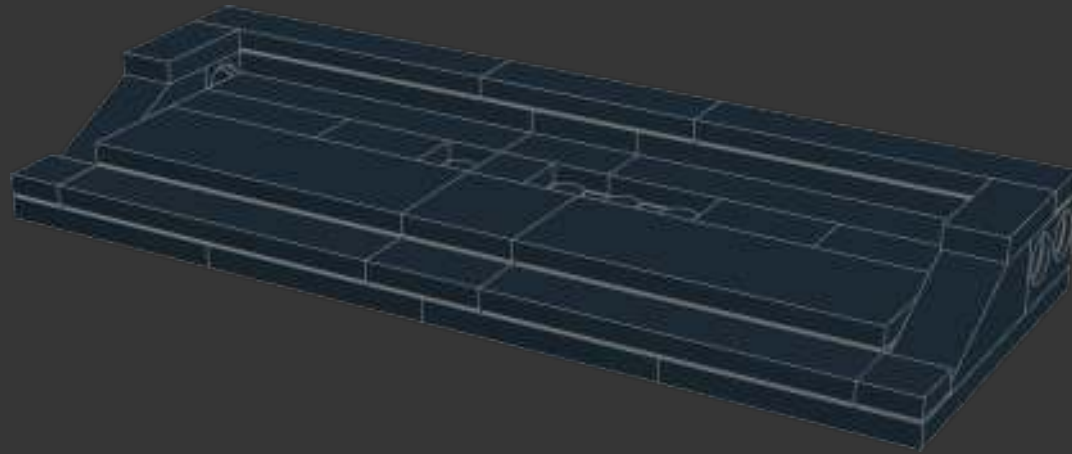

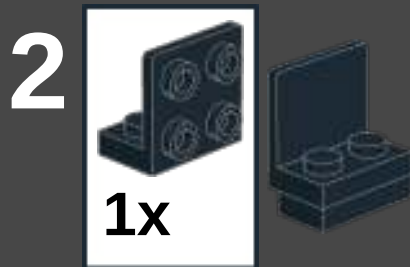

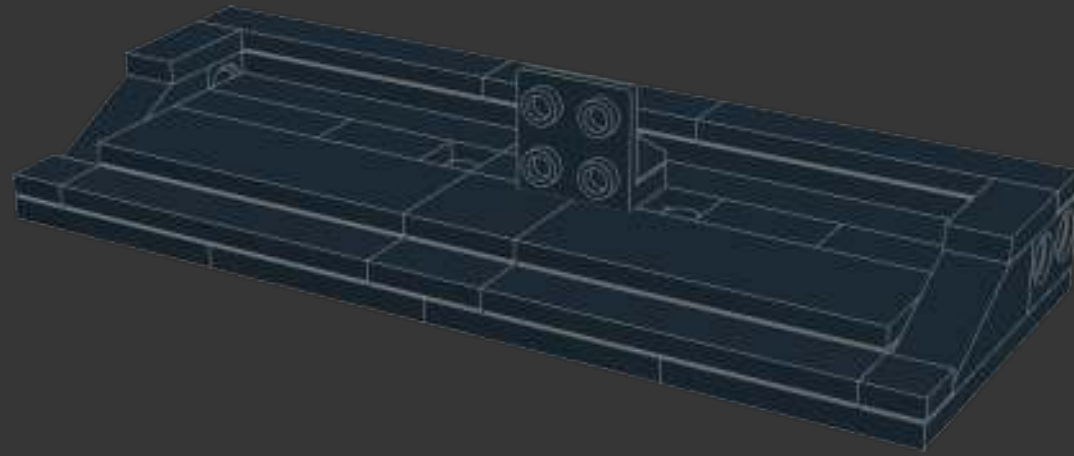

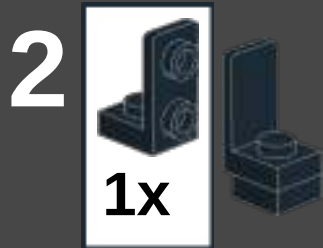

x2

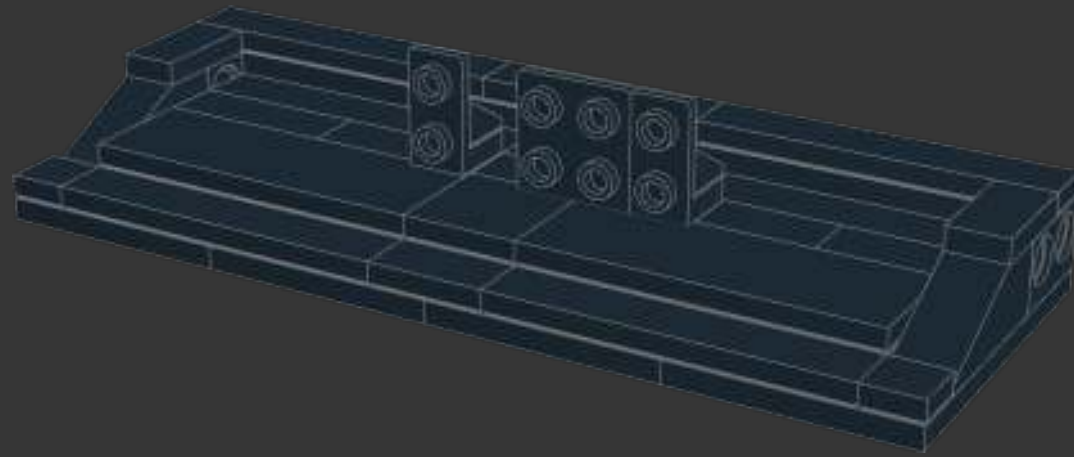

1

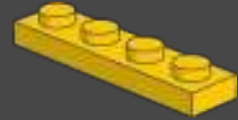
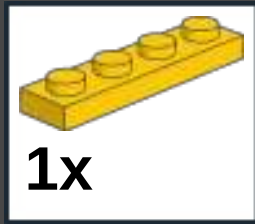

2

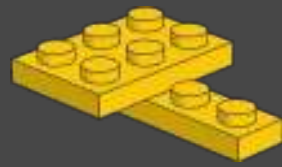
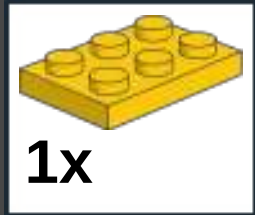

3

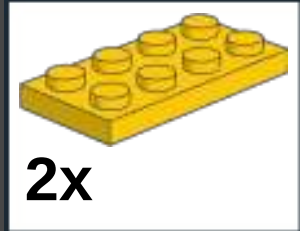

4



5

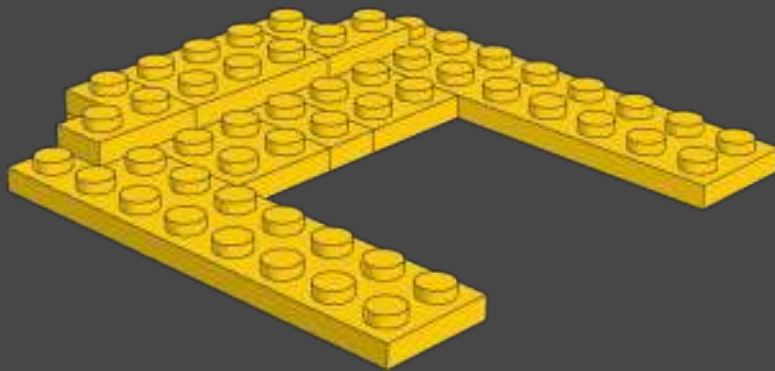
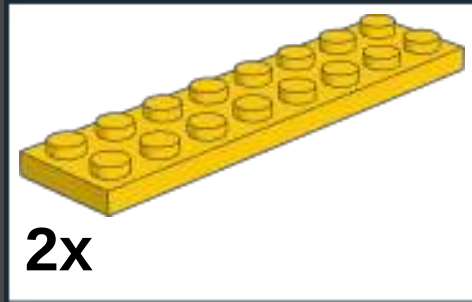

6

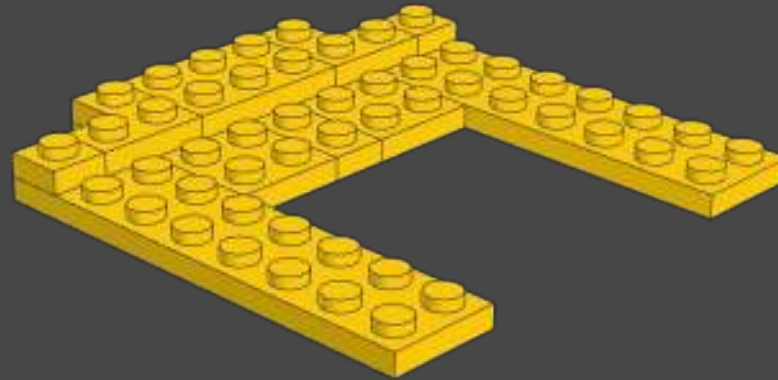

7

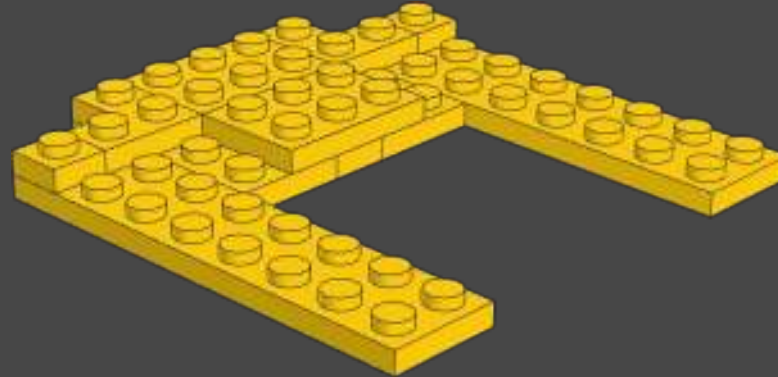
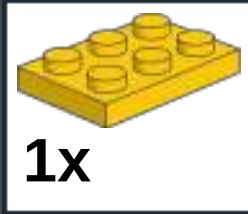

8

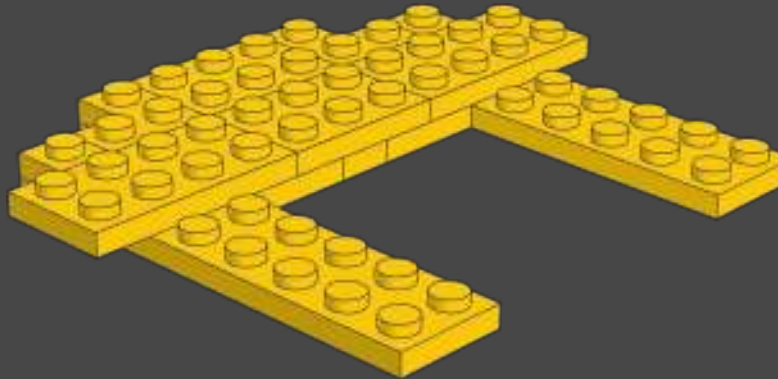
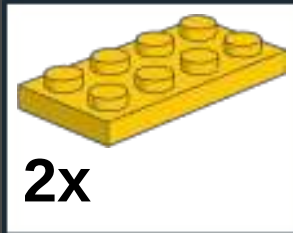

9

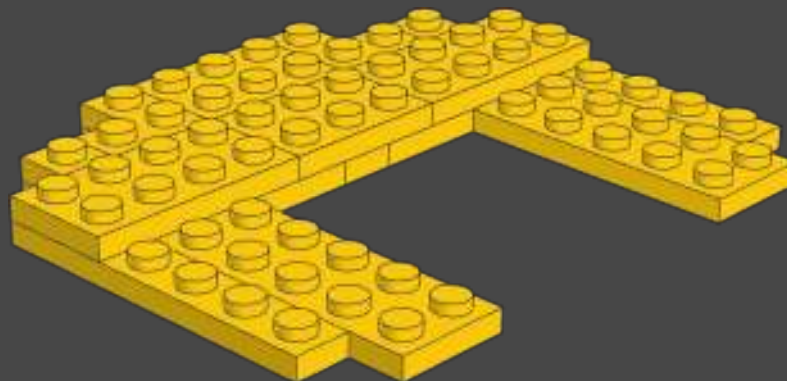
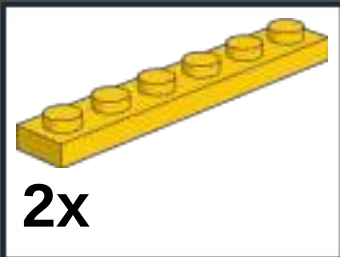

10

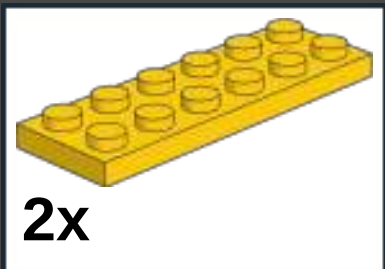

11

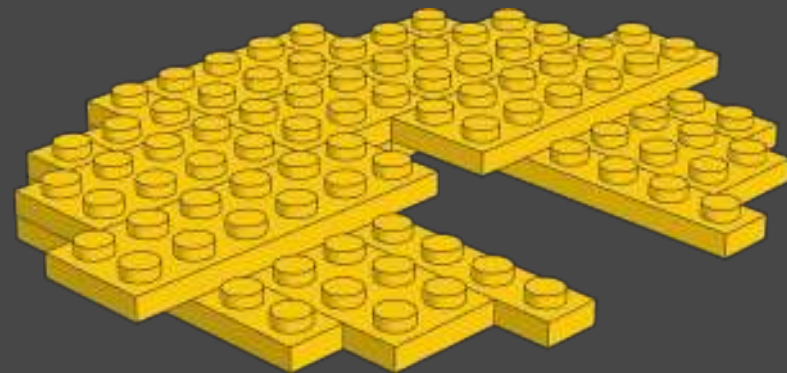
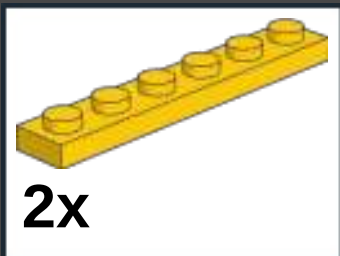

12

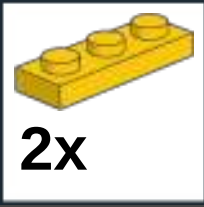

13

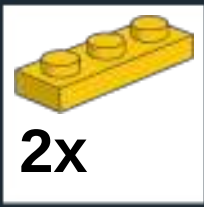

14



15

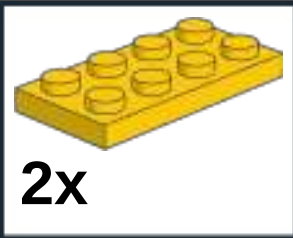

16

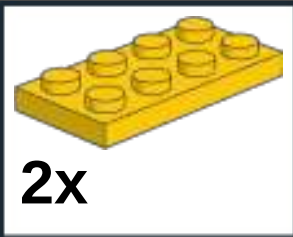

17

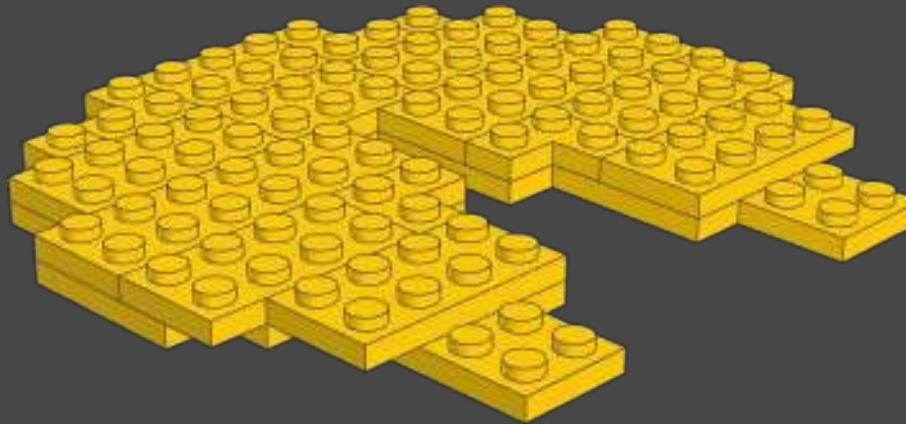

18

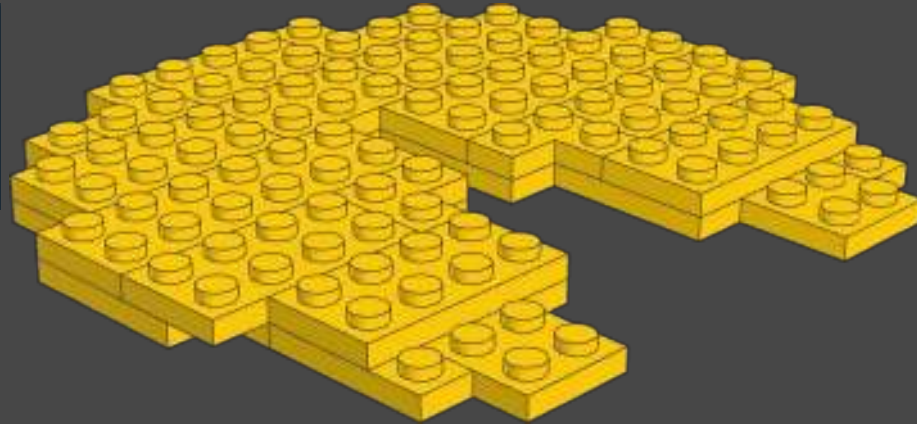
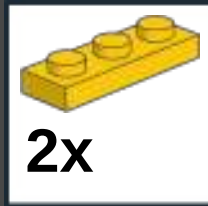

19

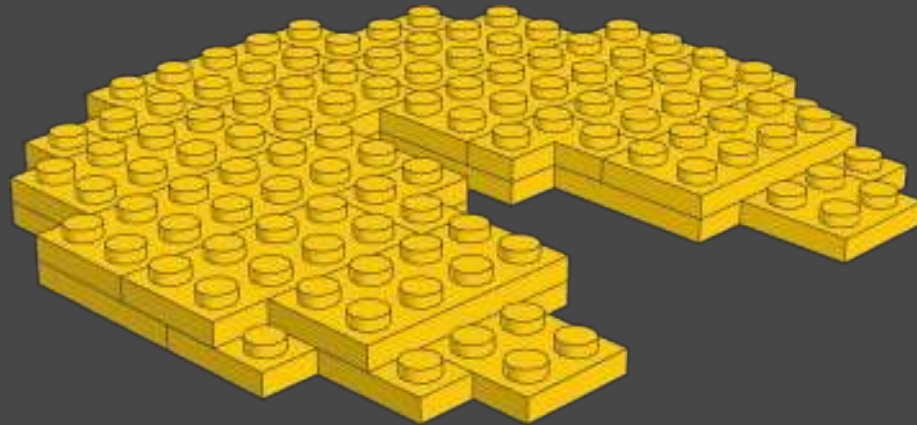

20

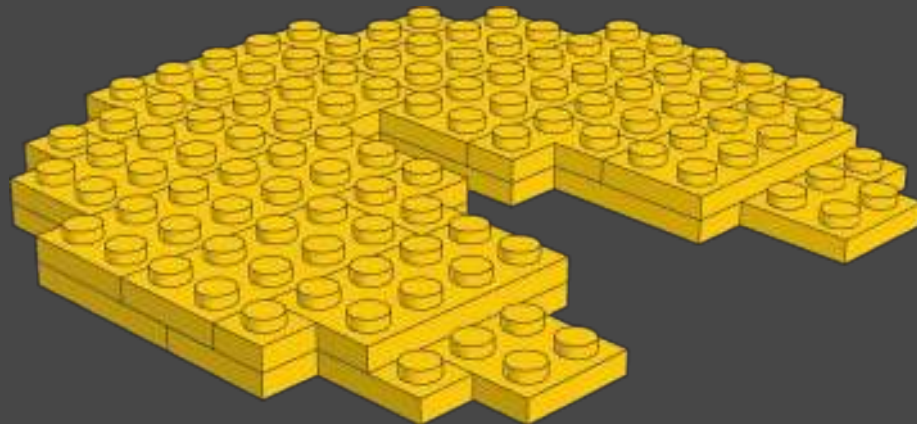

21

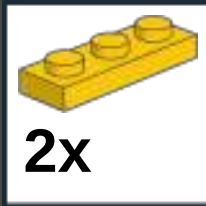

22

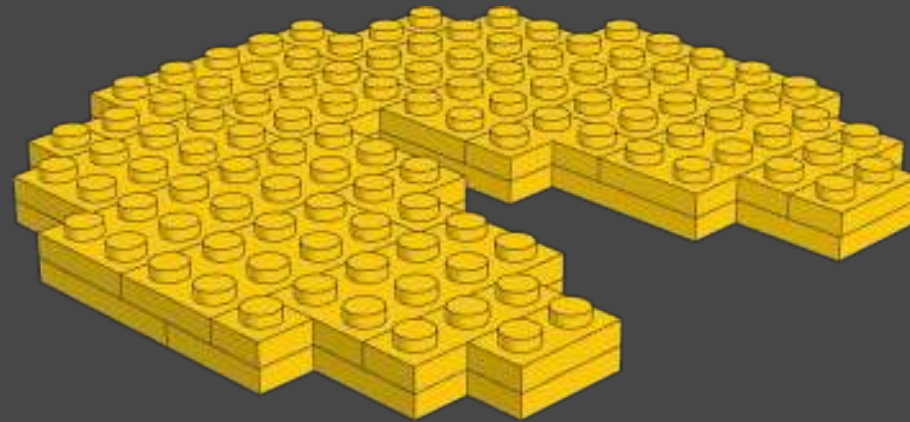

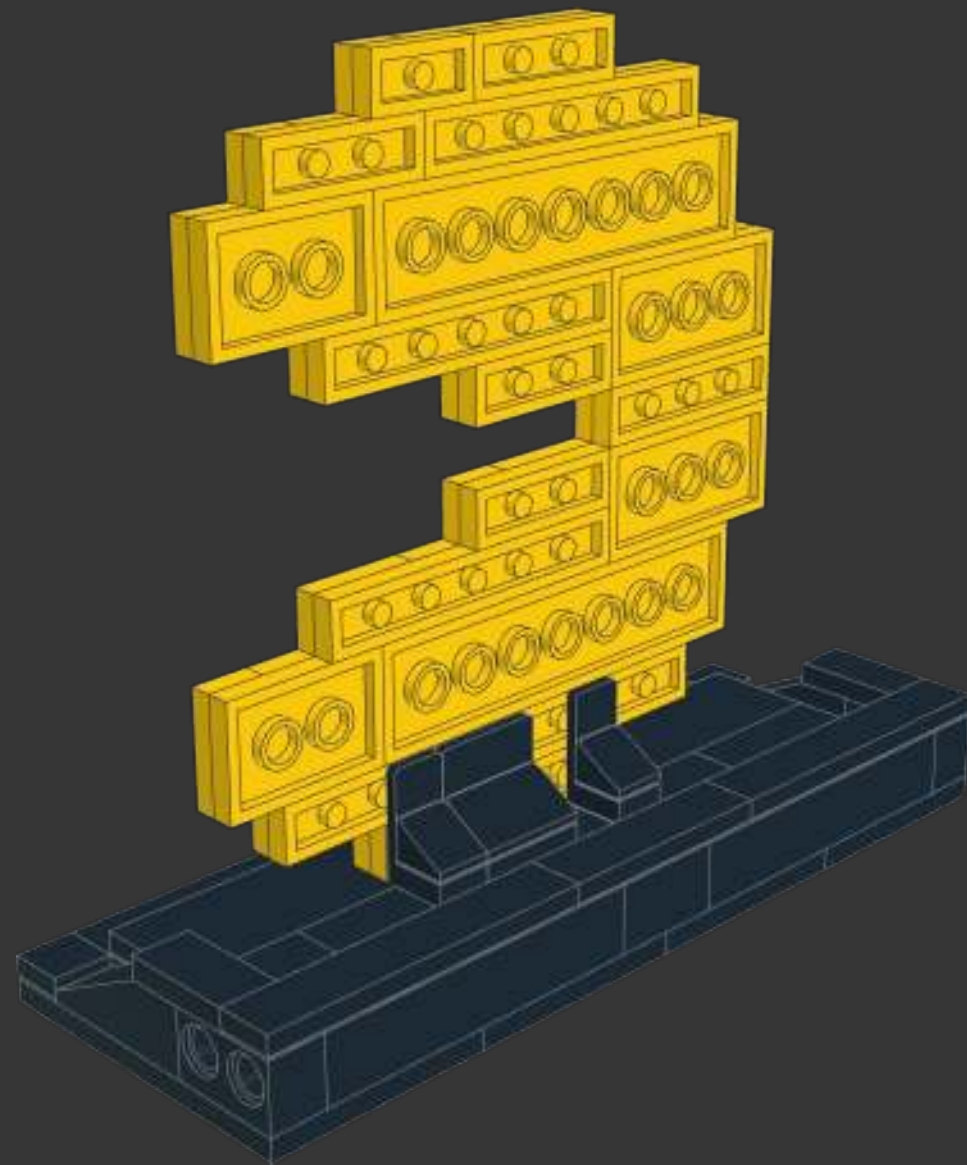

1

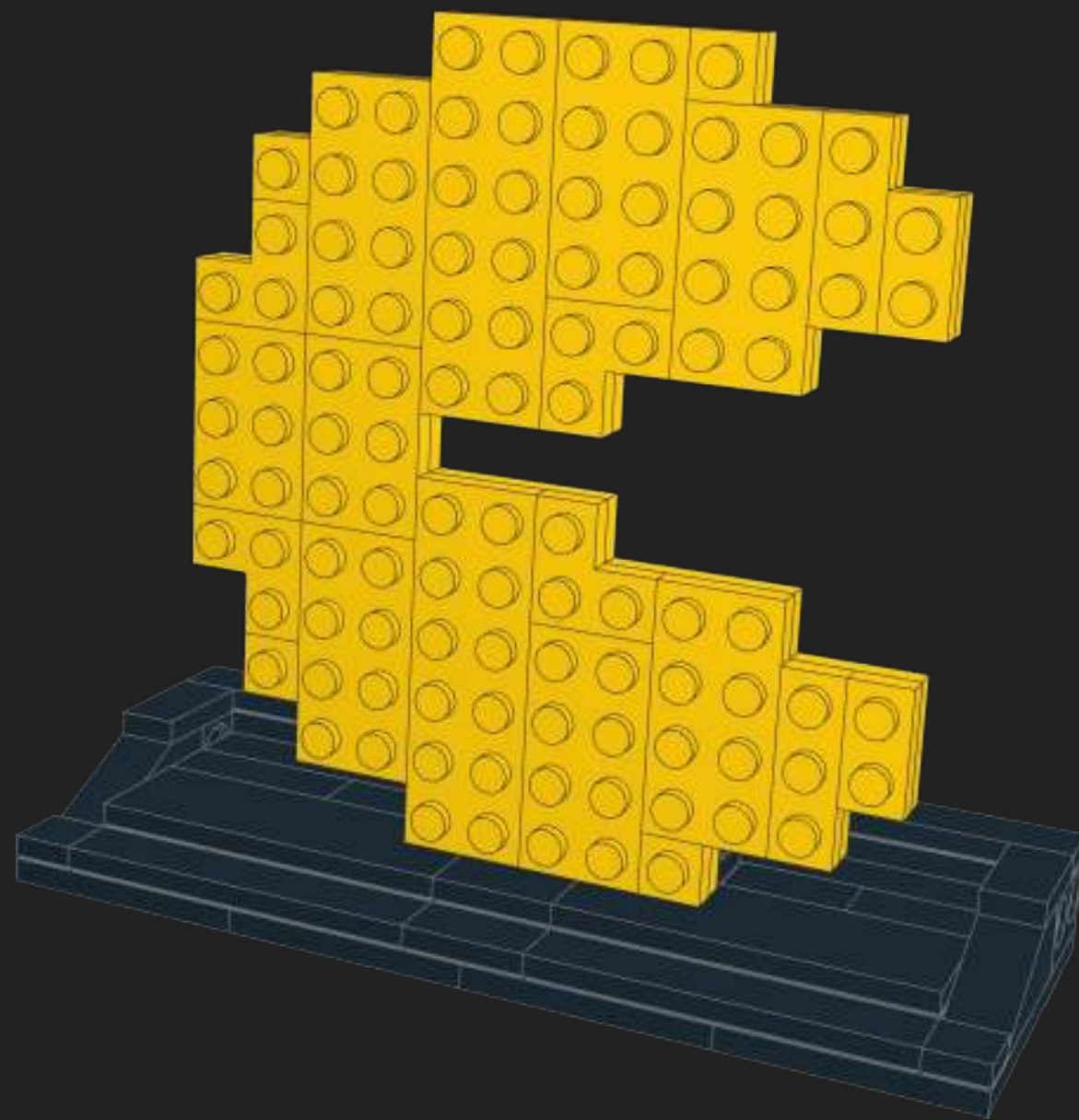



1x



1x



2x



6x



1x



1x



1x



2x



5x



3x



1x



2x



2x



1x



2x

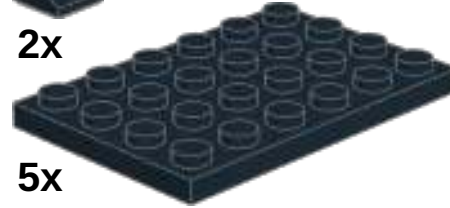

5x



4x



2x



2x

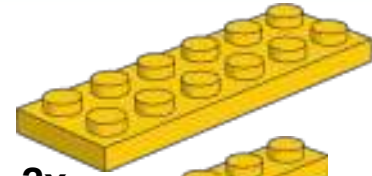

2x



4x



8x

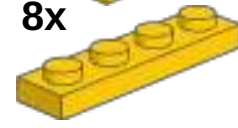

1x



4x

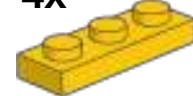

8x



4x



4x



4x



2x

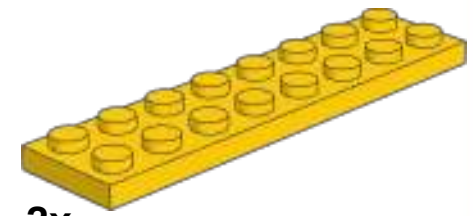

2x

Honorable mentions of supporters:

Teg12345

dalesr

csscg

Bwtpelego

inkachi

BIGBOYE

guest-982688

rob2190



Hope you have fun with this model and instructions.
As always you can reach out to me via email:

birdbrickbuilds@gmail.com

If you wish to help me continue to make this
models and instructions you can buy me a coffee
to help me stay up late:

<https://www.buymeacoffee.com/birdbrickbl>

You can also check my work on rebrickable and
instagram:

<https://rebrickable.com/users/birdbrickbuilds/>
<https://www.instagram.com/birdbrickbuilds/>

Or you can buy my Coffee Espresso MOC:

<https://reb.li/m/118798>

Or even you can buy my Beer Mug MOC:

<https://reb.li/m/137364>



This work is licensed under a [Creative Commons Attribution-NonCommercial-ShareAlike 4.0 International License](https://creativecommons.org/licenses/by-nc-sa/4.0/).