

Mustaches

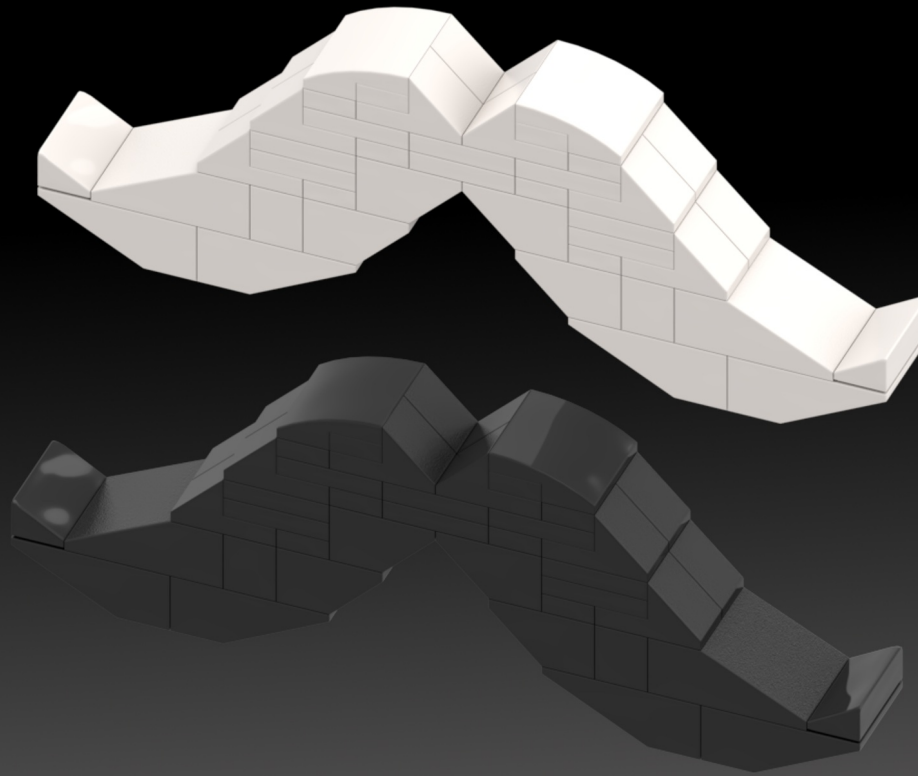

Instructions by Bird Brick Builds
Author: Eduardo Sousa
88 Parts



Original Author: Bolbuyk
Original Model: <https://rebrickable.com/mocs/MOC-1688/Bolbuyk/moustache/#details>



Attribution-NonCommercial-ShareAlike 4.0 International (CC BY-NC-SA 4.0)

This is a human-readable summary of (and not a substitute for) the [license](#). [Disclaimer](#).

You are free to:

Share — copy and redistribute the material in any medium or format

Adapt — remix, transform, and build upon the material

The licensor cannot revoke these freedoms as long as you follow the license terms.

Under the following terms:



Attribution — You must give [appropriate credit](#), provide a link to the license, and [indicate if changes were made](#). You may do so in any reasonable manner, but not in any way that suggests the licensor endorses you or your use.



NonCommercial — You may not use the material for [commercial purposes](#).



ShareAlike — If you remix, transform, or build upon the material, you must distribute your contributions under the [same license](#) as the original.

No additional restrictions — You may not apply legal terms or [technological measures](#) that legally restrict others from doing anything the license permits.

Notices:

You do not have to comply with the license for elements of the material in the public domain or where your use is permitted by an applicable [exception or limitation](#).

No warranties are given. The license may not give you all of the permissions necessary for your intended use. For example, other rights such as [publicity, privacy, or moral rights](#) may limit how you use the material.

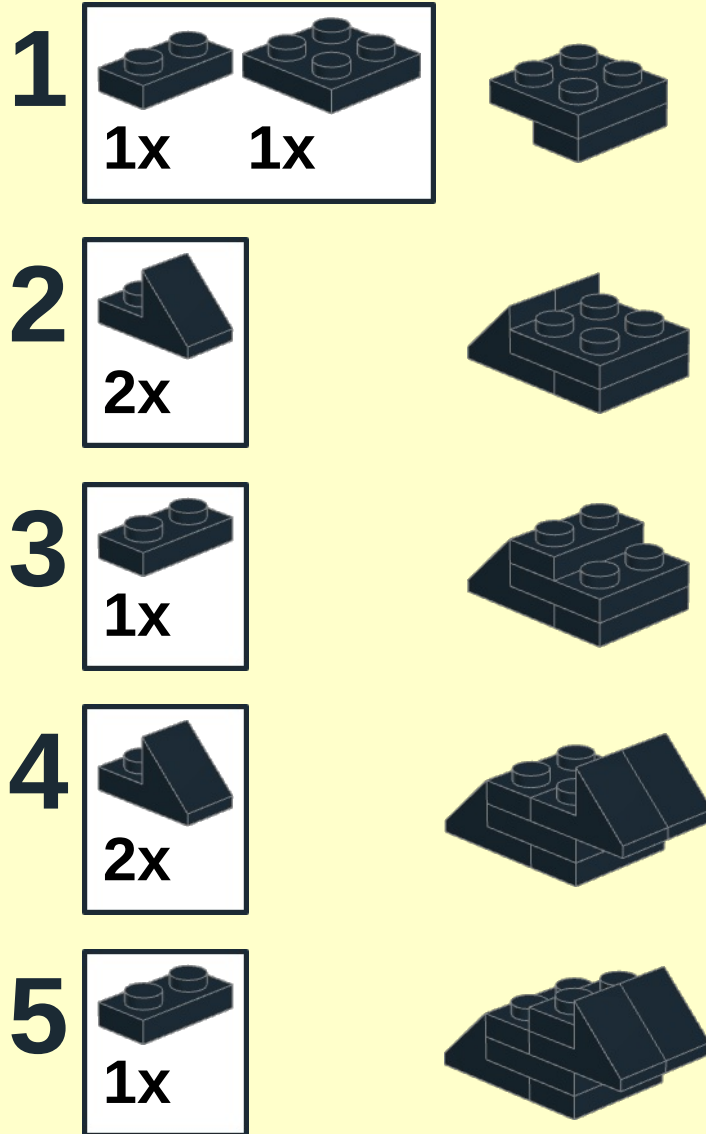

6

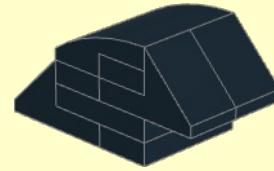
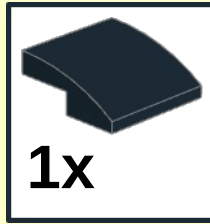

7

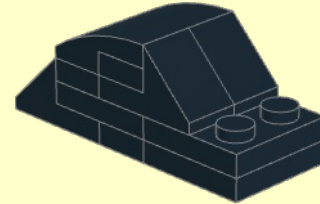

8

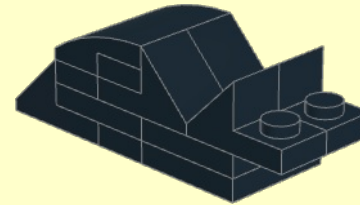
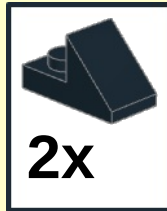

9

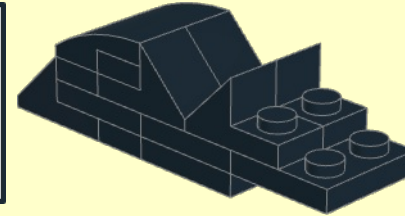
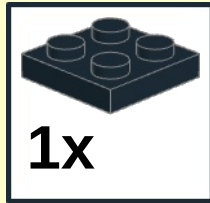

10

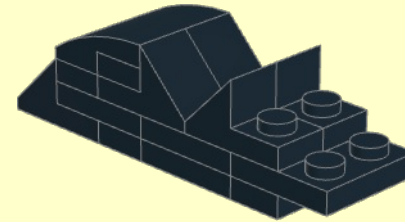
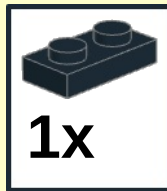

11



2x

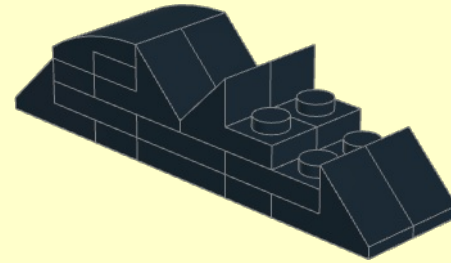

12



2x

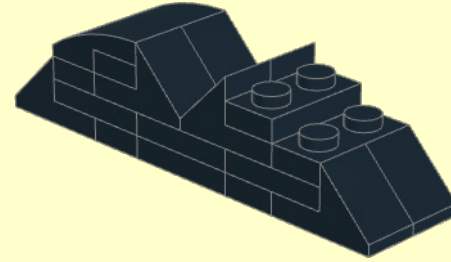

13



1x

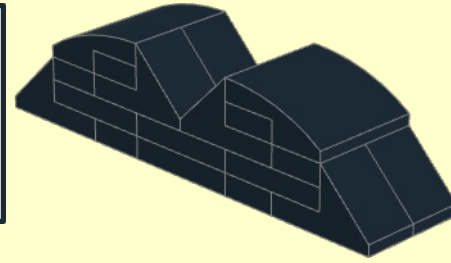

14

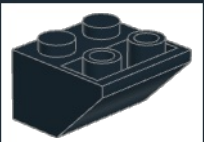

2x

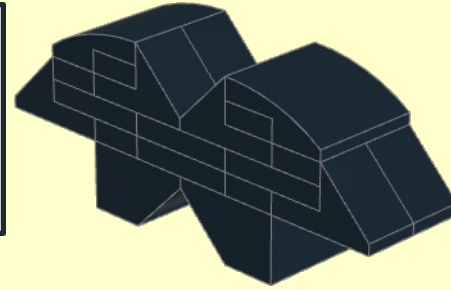

15

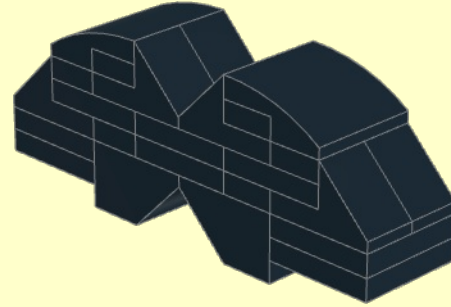
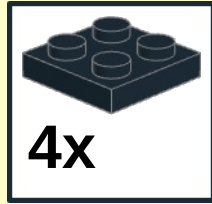

16

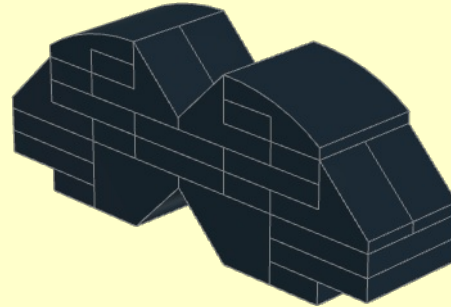
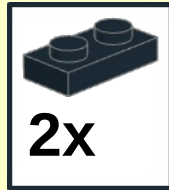

17

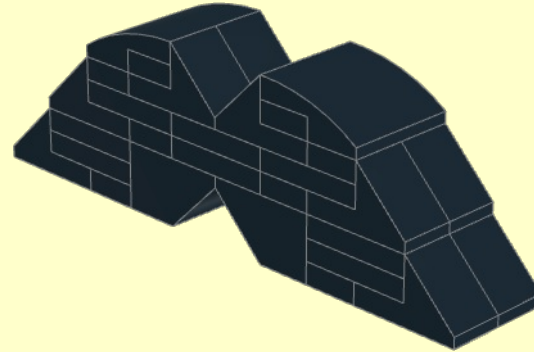

18

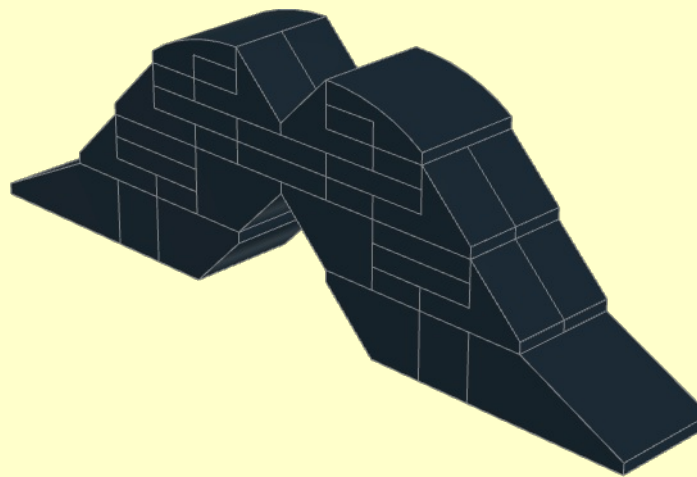
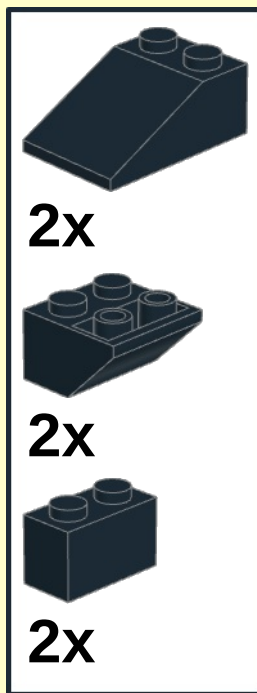

19

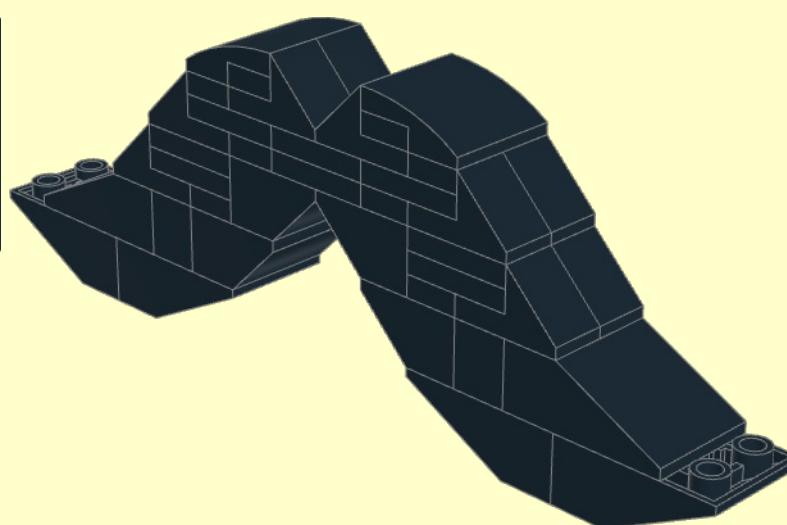
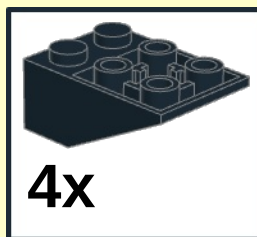

20

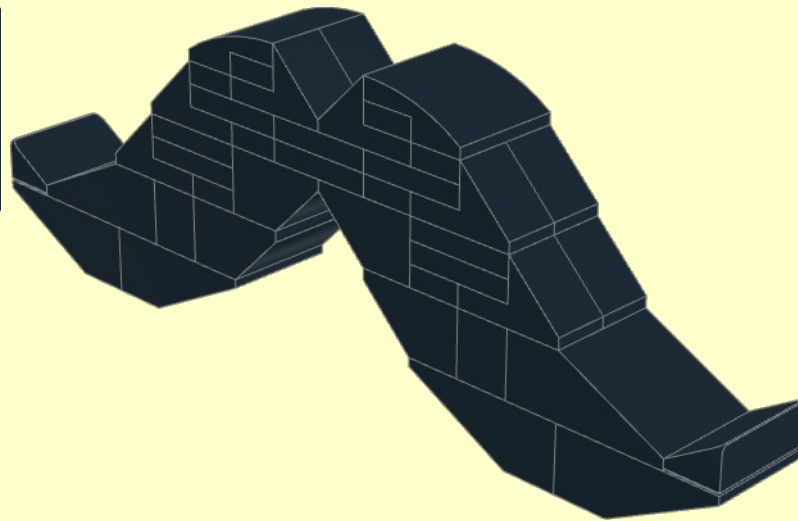

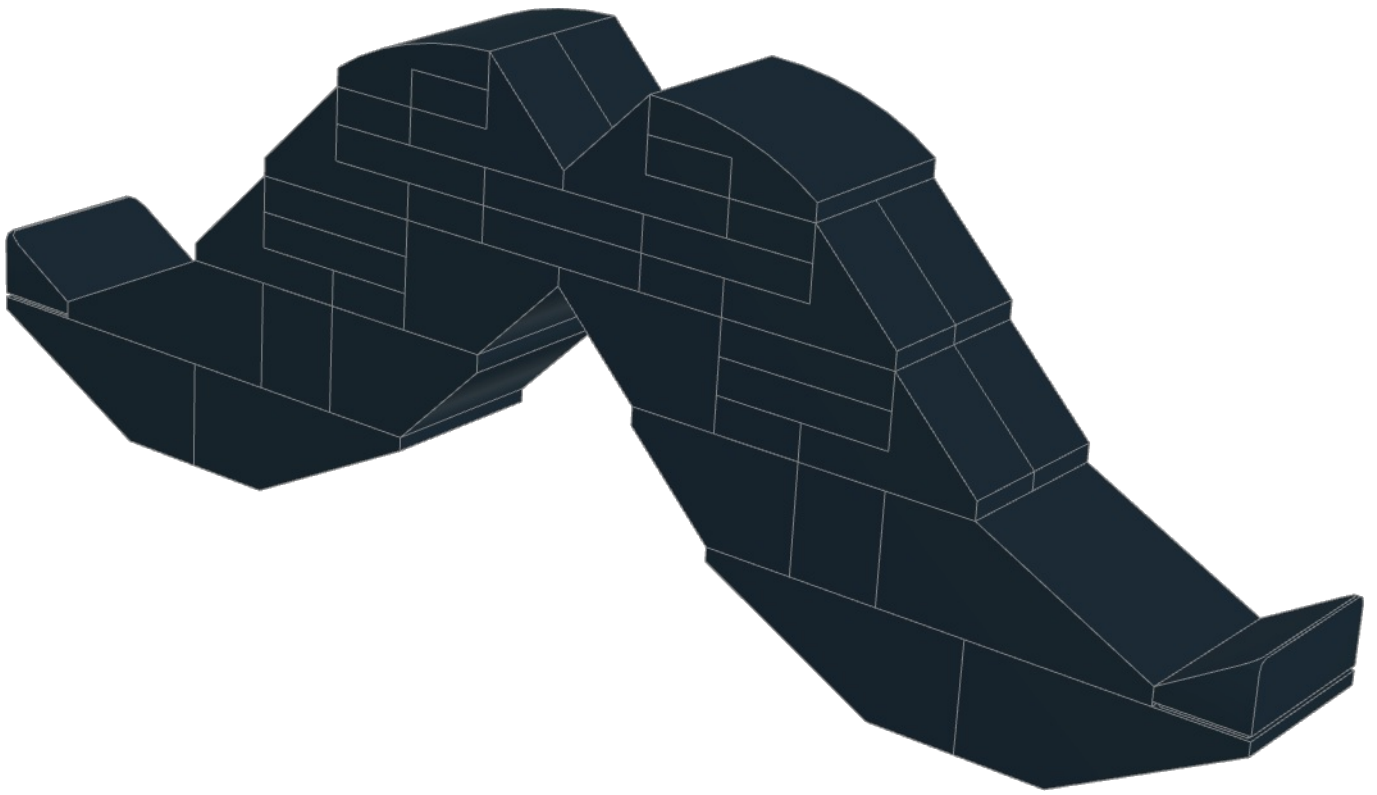

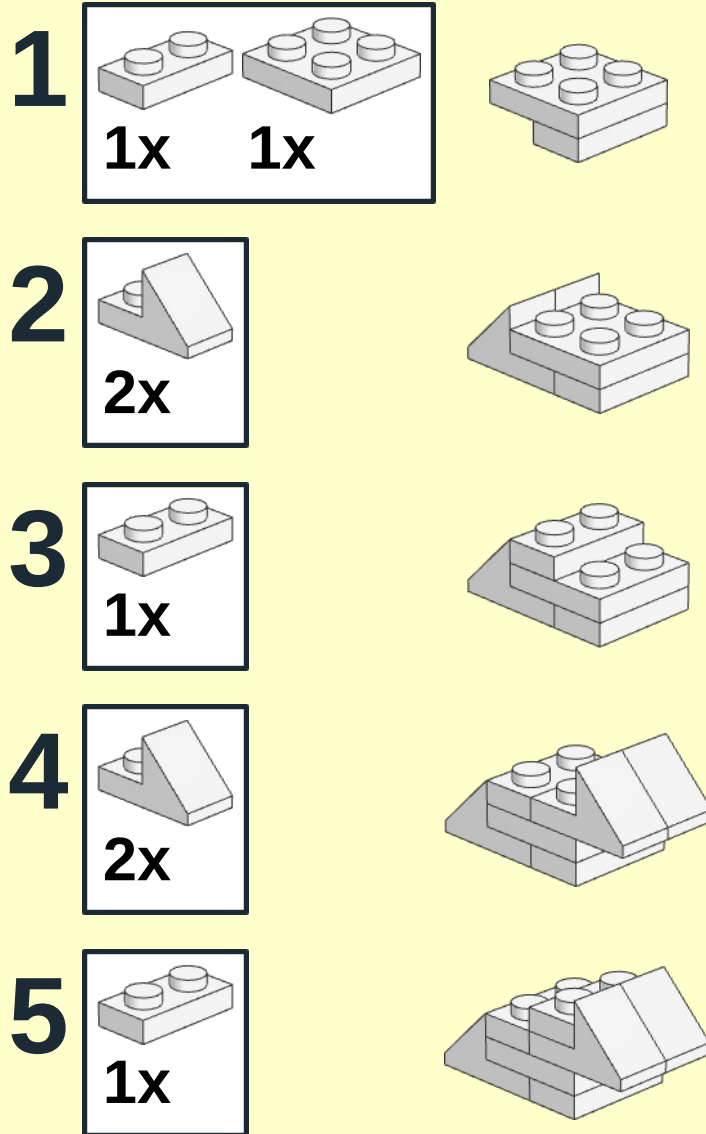

6

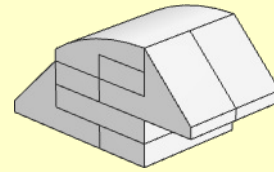
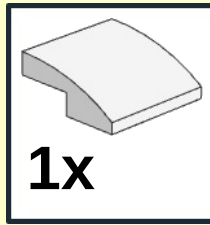

7

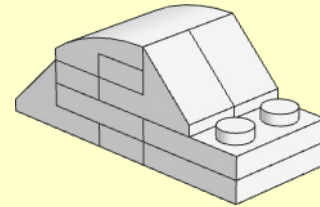
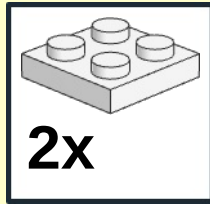

8

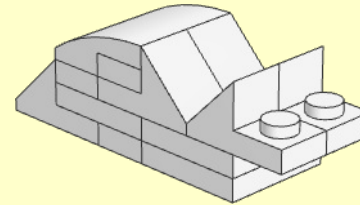
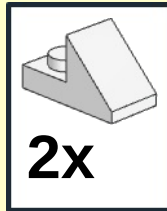

9

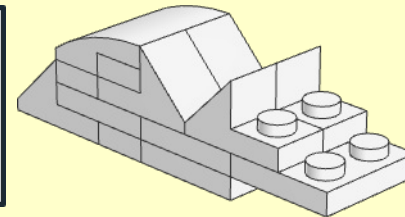
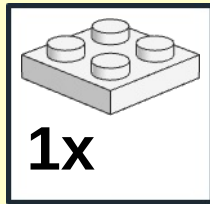

10

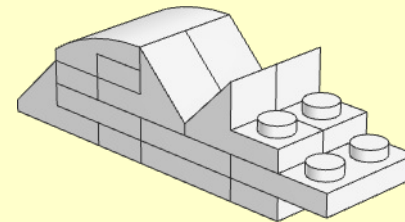
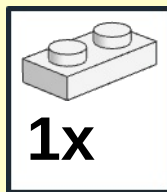

15

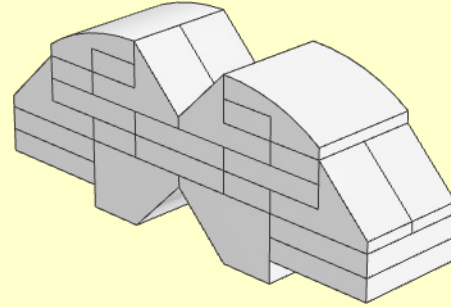
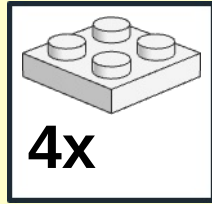

16

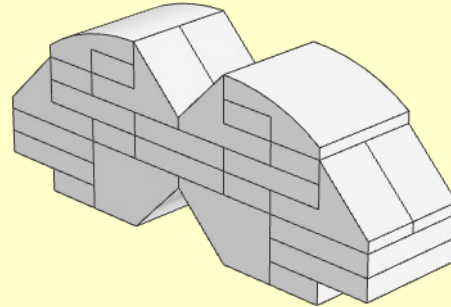
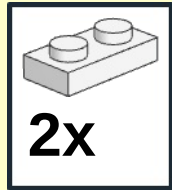

17

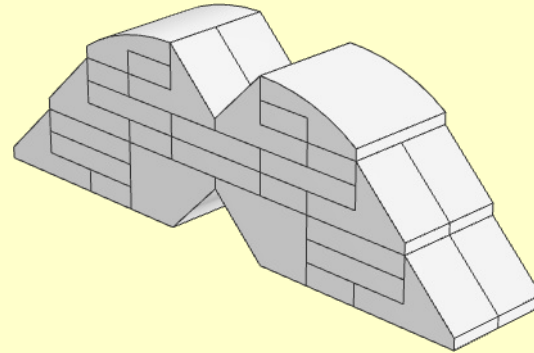
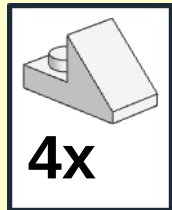

18

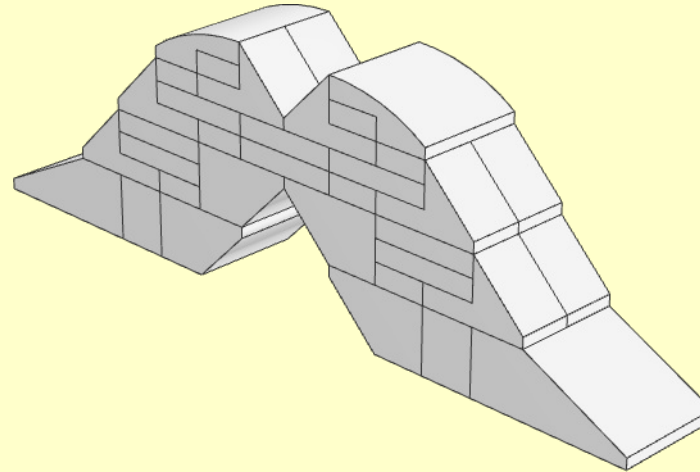
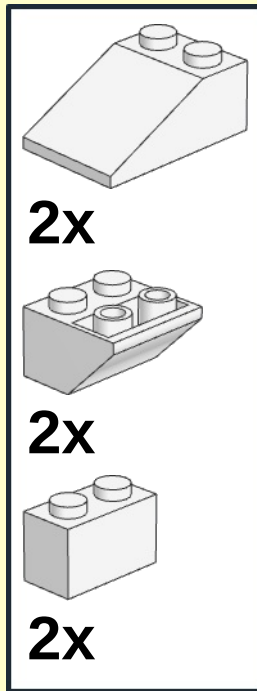

19

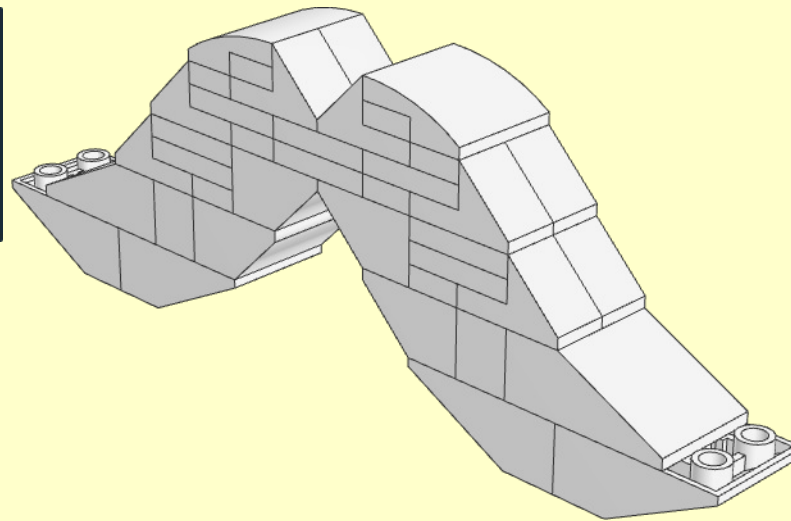
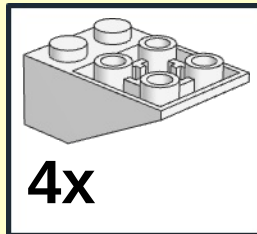

20

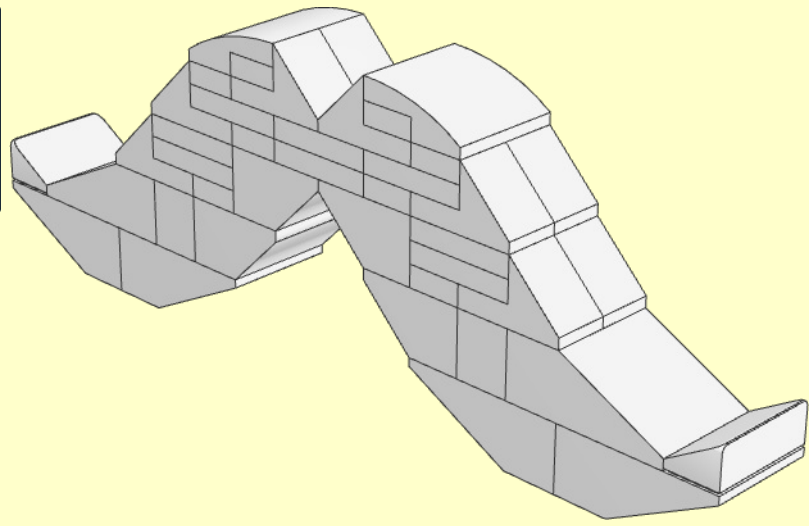
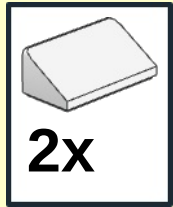

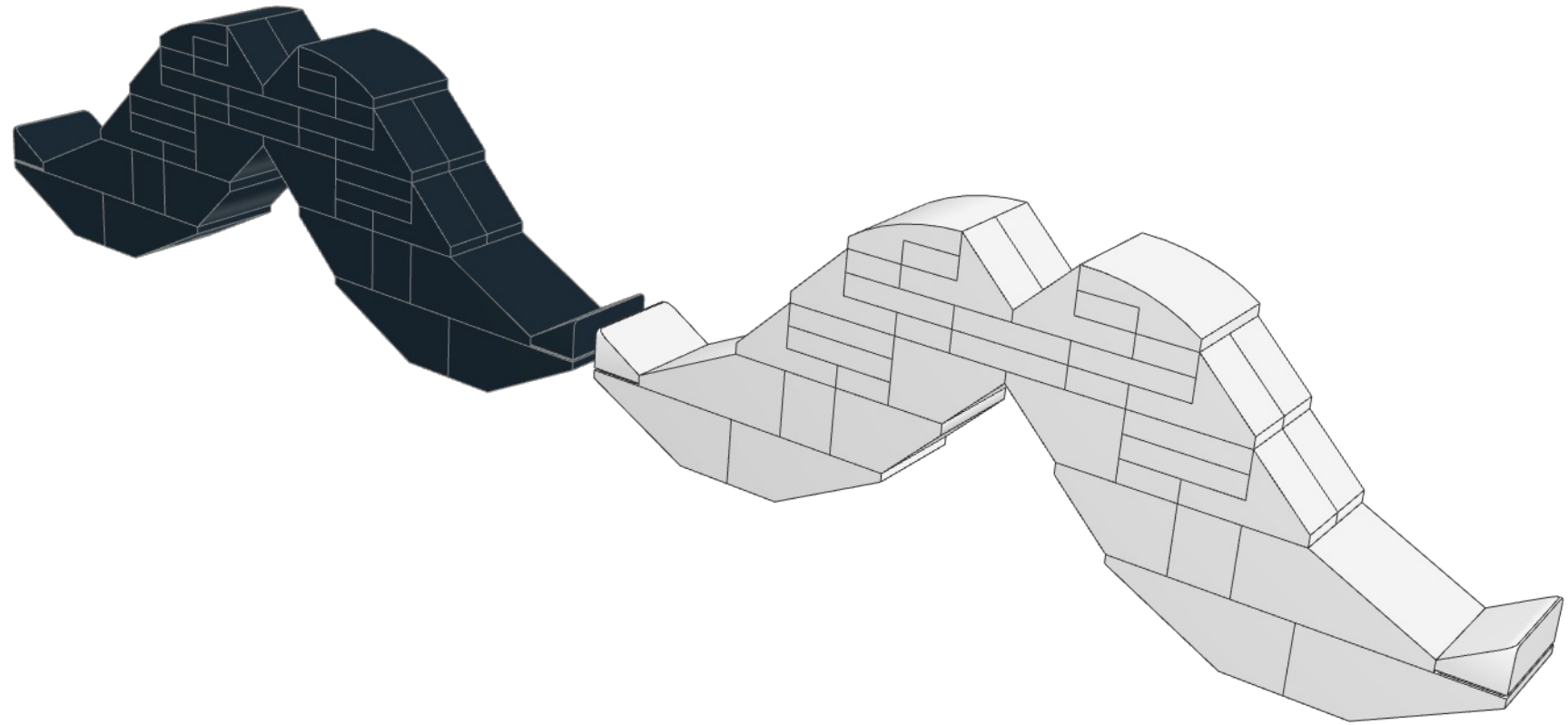

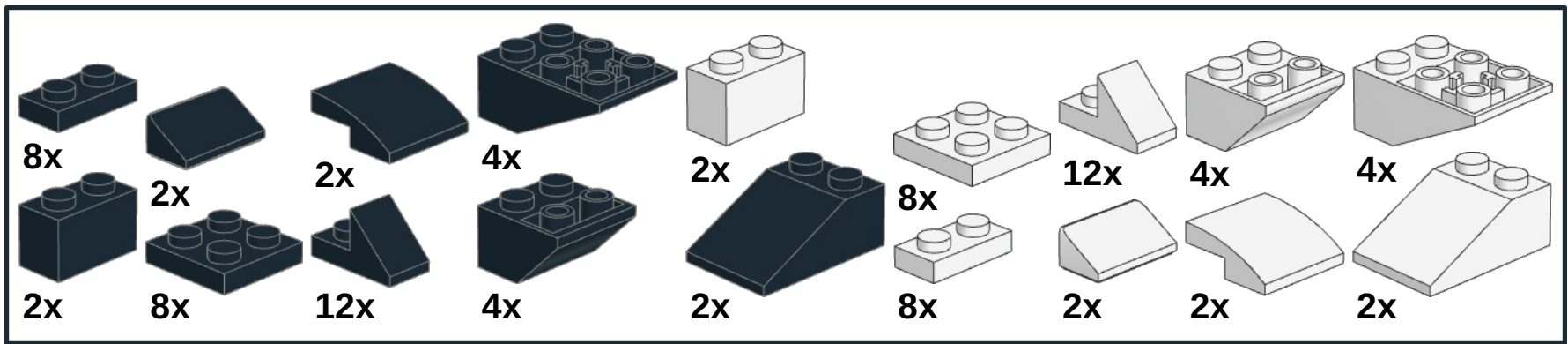

Hope you had fun with this model and instructions.
As always you can reach out to me via email:

birdbrickbuilds@gmail.com

You can also check my work on rebrickable and
instagram:

<https://rebrickable.com/users/birdbrickbuilds/>

<https://www.instagram.com/birdbrickbuilds/>

If you wish to help me continue to make this
models and instructions you can buy me a coffee
to help me stay up late:

<https://www.buymeacoffee.com/birdbrickbl>

**LEGO® is a registered trademark of the LEGO Group,
which does not sponsor, endorse, or authorize these
instructions or the model they depict.**

Instructions configured and generated using LPub3D 2.4.3.0.2557
Download LPub3D at <https://trevorsandy.github.io/lpub3d/>



This work is licensed under a [Creative Commons Attribution-NonCommercial-ShareAlike 4.0 International License](https://creativecommons.org/licenses/by-nc-sa/4.0/).