

TIME 9

DOUBLE DRAGON

双截龙

Jeff

Model instructions by
Bird Brick Builds

Author: Eduardo Sousa



129 Parts

WORK RAM	OK
ROM 1	OK
ROM 2	OK
ROM 3	OK
ROM 4	OK
63701	OK





Attribution-NonCommercial-ShareAlike 4.0 International (CC BY-NC-SA 4.0)

This is a human-readable summary of (and not a substitute for) the [license](#). [Disclaimer](#).

You are free to:

Share — copy and redistribute the material in any medium or format

Adapt — remix, transform, and build upon the material

The licensor cannot revoke these freedoms as long as you follow the [license terms](#).

Under the following terms:



Attribution — You must give [appropriate credit](#), provide a link to the license, and [indicate if changes were made](#). You may do so in any reasonable manner, but not in any way that suggests the licensor endorses you or your use.



NonCommercial — You may not use the material for [commercial purposes](#).



ShareAlike — If you remix, transform, or build upon the material, you must distribute your contributions under the [same license](#) as the original.

No additional restrictions — You may not apply legal terms or [technological measures](#) that legally restrict others from doing anything the license permits.

Notices:

You do not have to comply with the license for elements of the material in the public domain or where your use is permitted by an applicable [exception or limitation](#).

No warranties are given. The license may not give you all of the permissions necessary for your intended use. For example, other rights such as [publicity, privacy, or moral rights](#) may limit how you use the material.

1

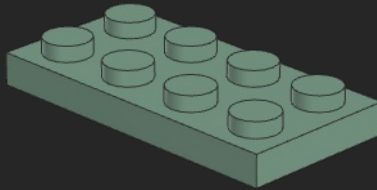
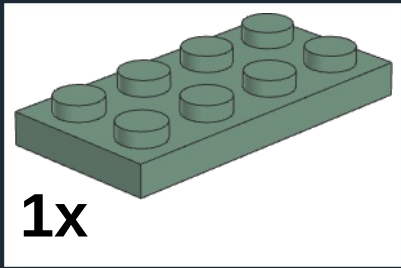

2

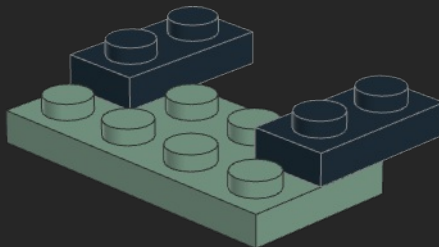
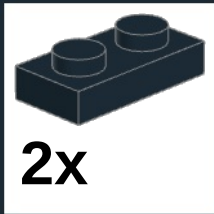

3

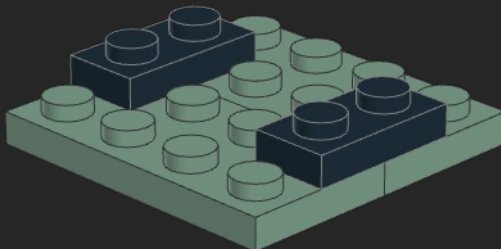
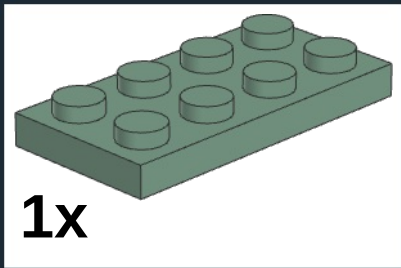

4

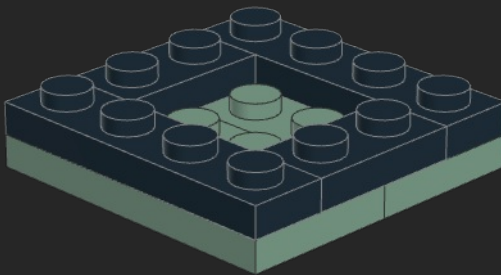
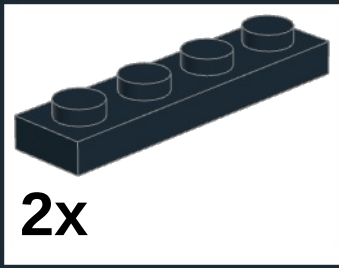

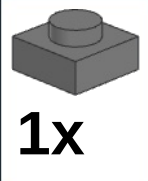
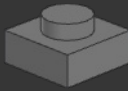
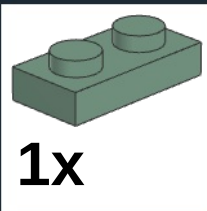
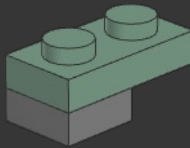
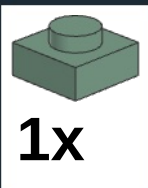
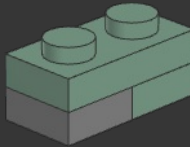
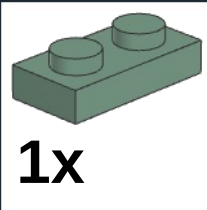
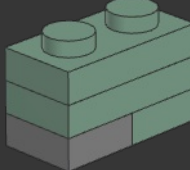
- 1  **1x** 
- 2  **1x** 
- 3  **1x** 
- 4  **1x** 

x2

5

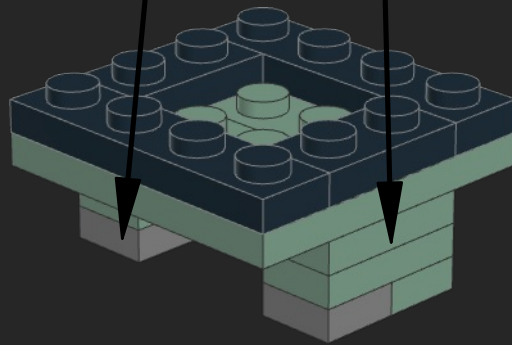
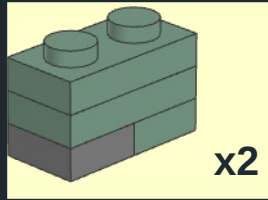

6

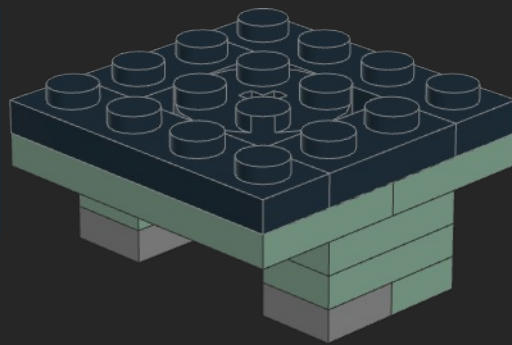
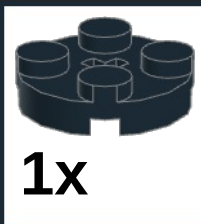

7

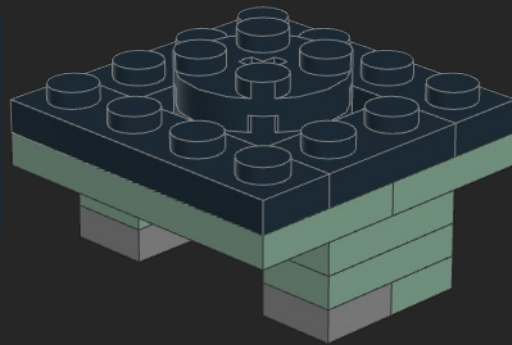
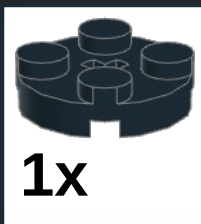

8

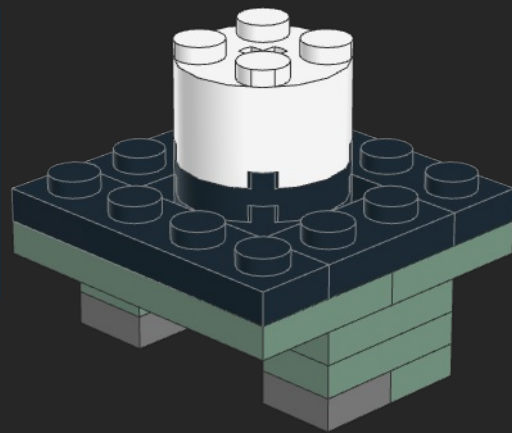
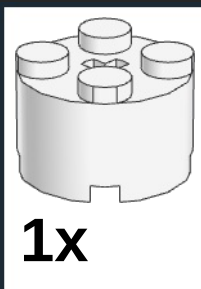

9

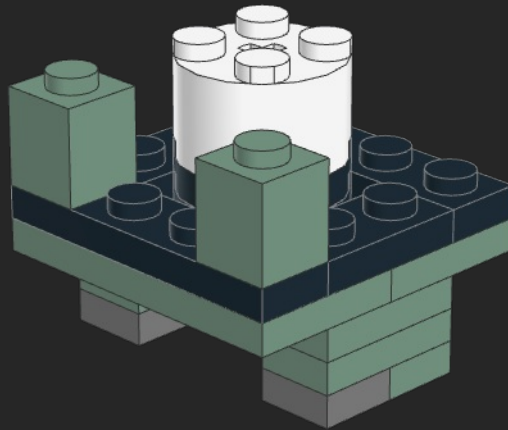

10

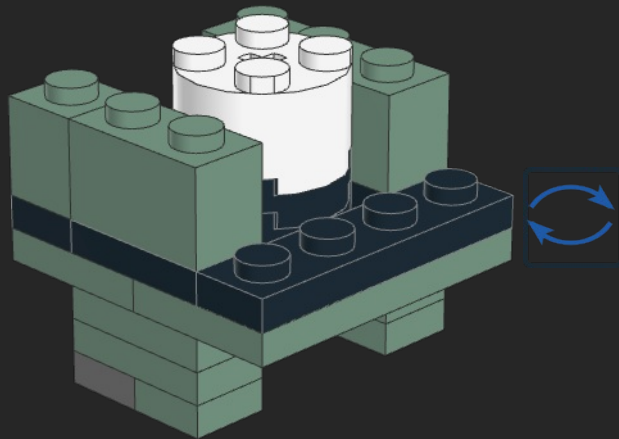
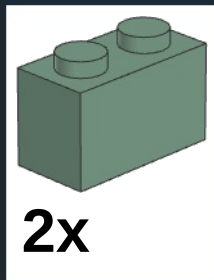

11

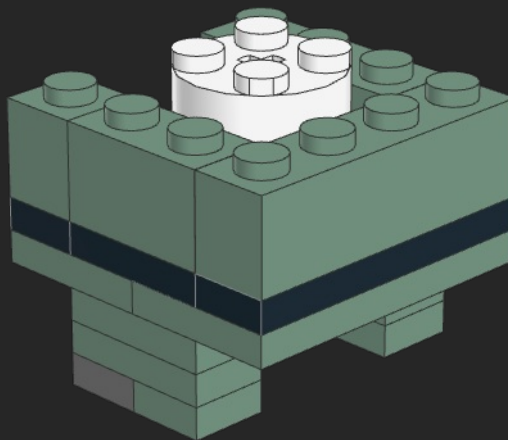
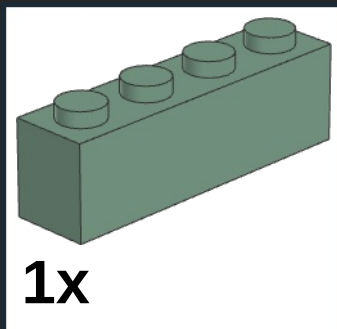

12

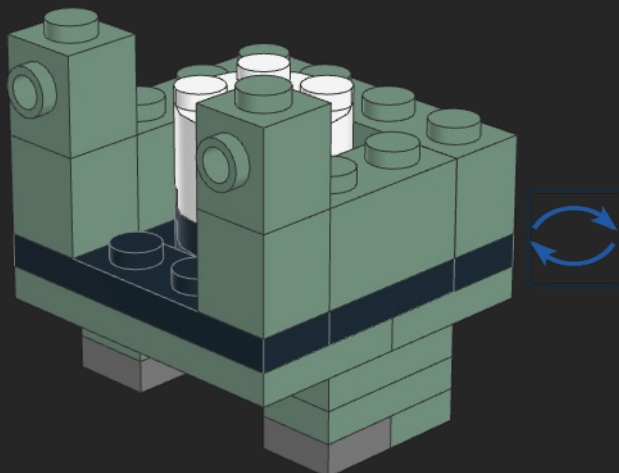

13

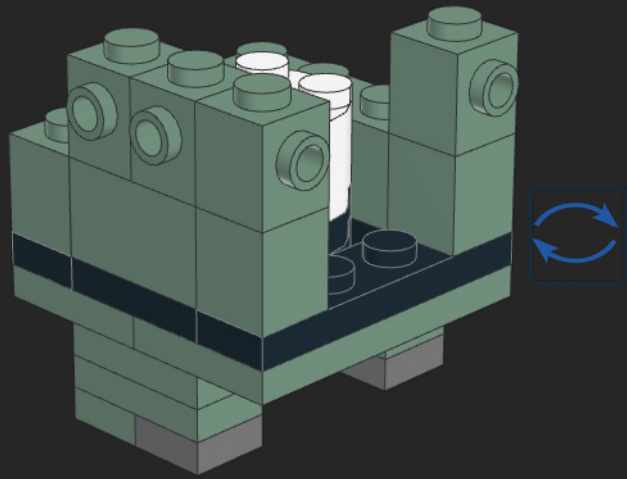

14

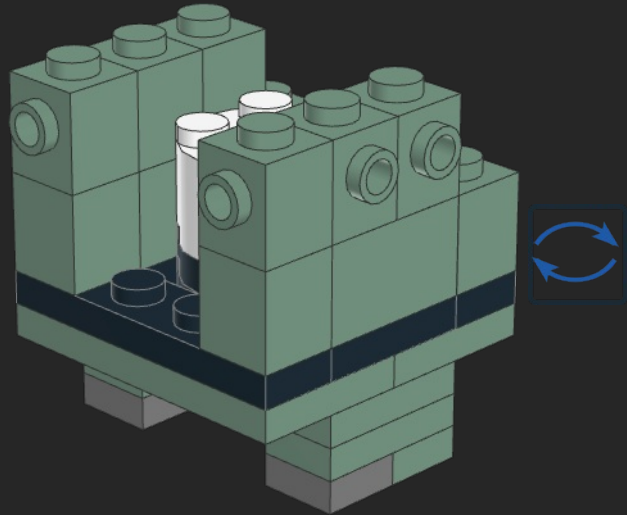

15

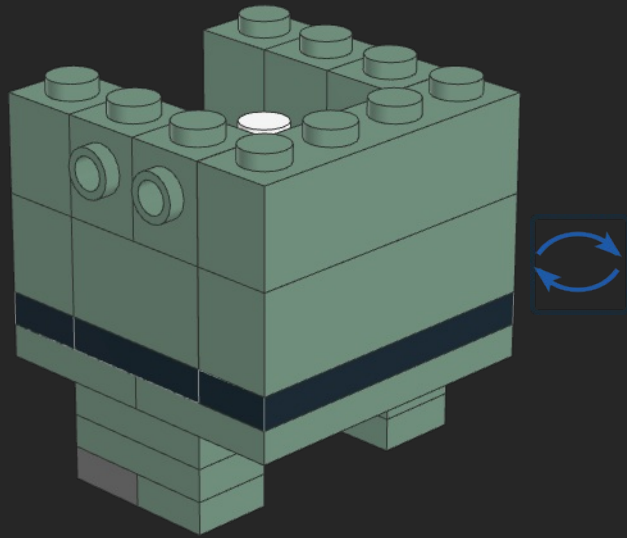
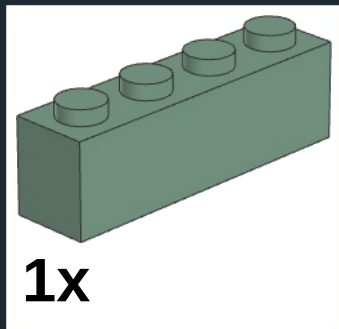

16

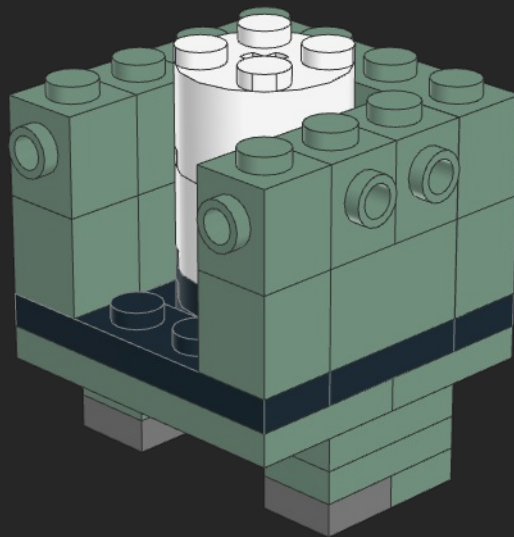
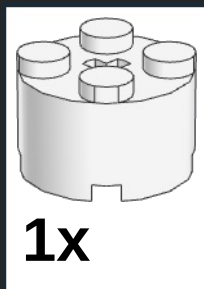

1

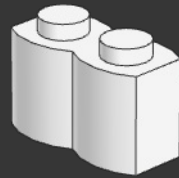
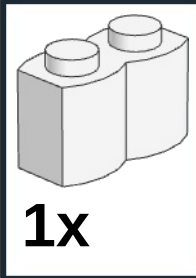

2

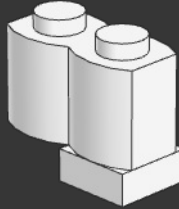
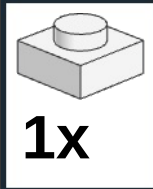

3

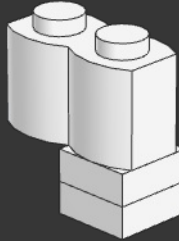
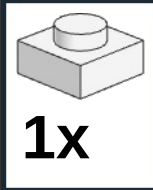

4

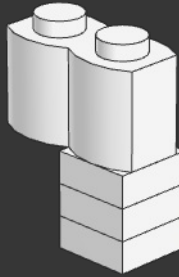
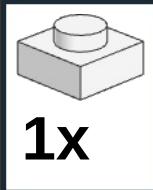

5

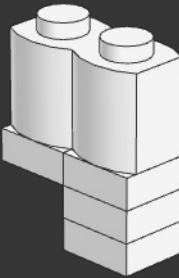
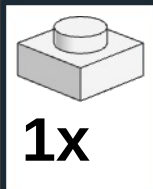

6

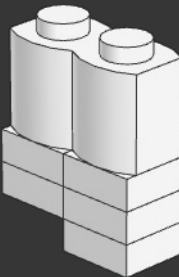
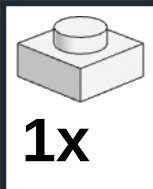

7

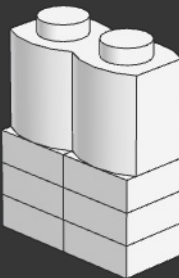
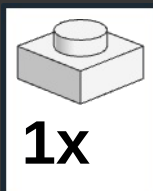

17

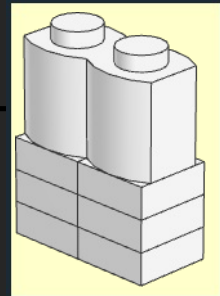
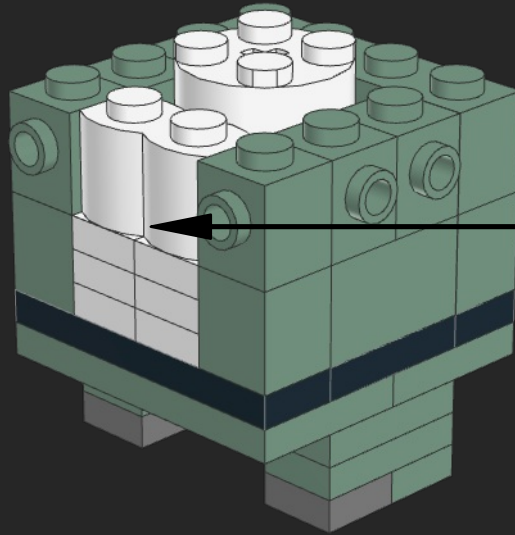

18

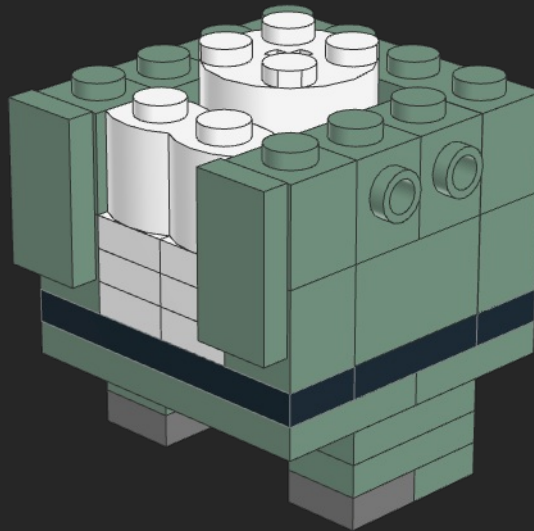
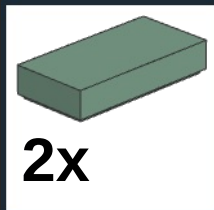

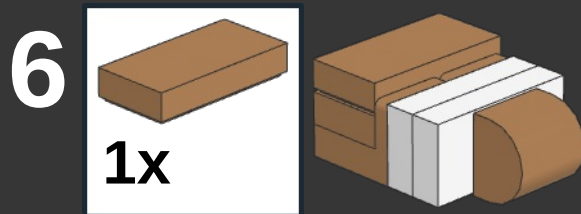
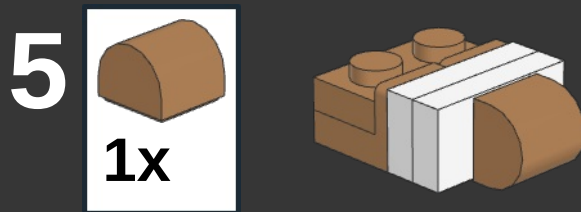
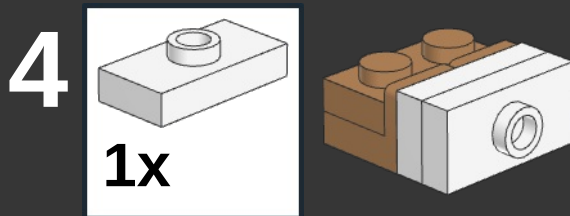
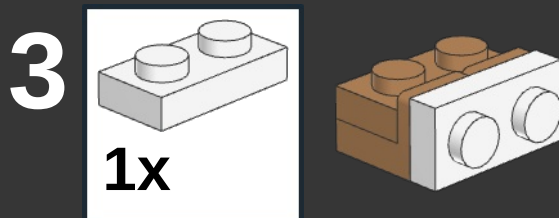
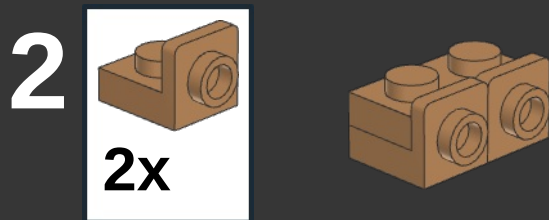
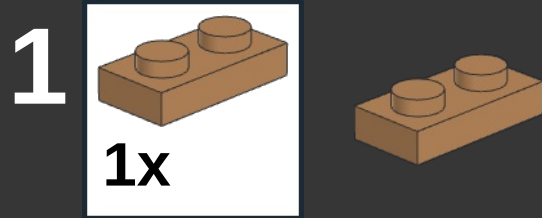

x2

19

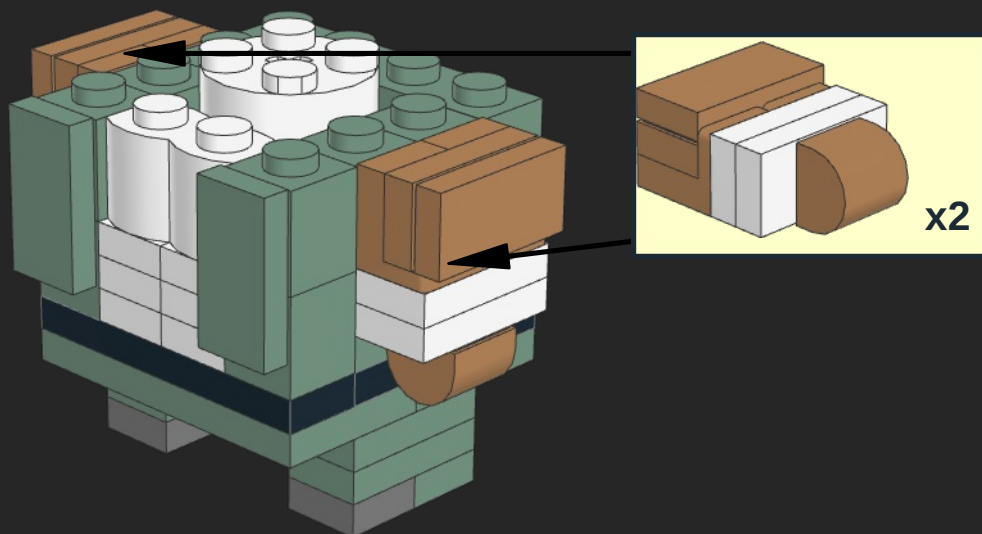

20

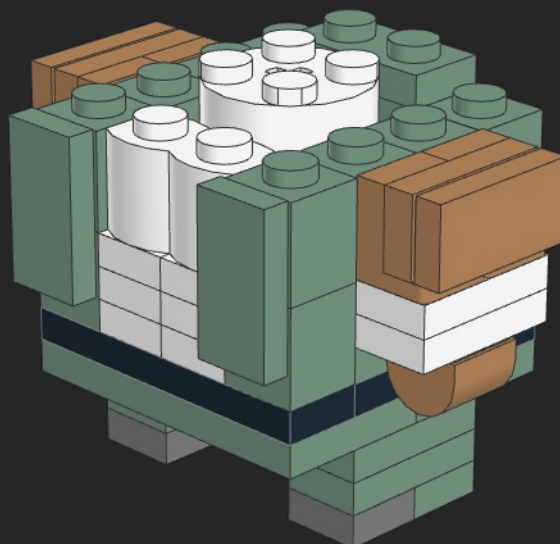
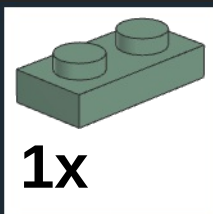

21

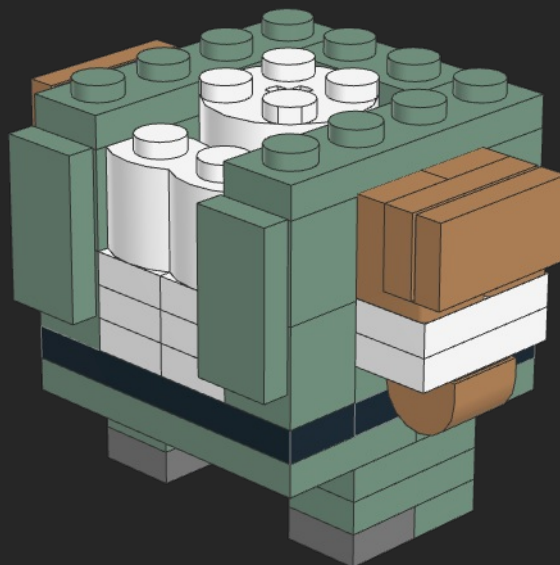
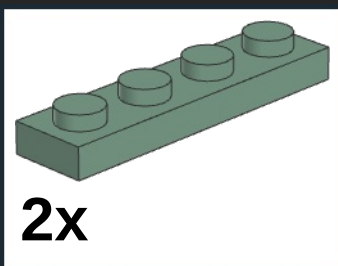

22

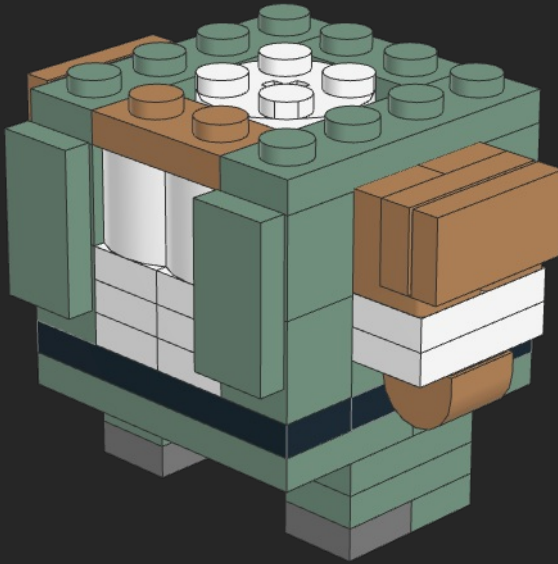
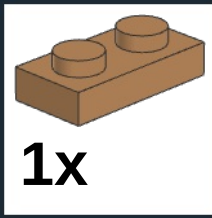

23

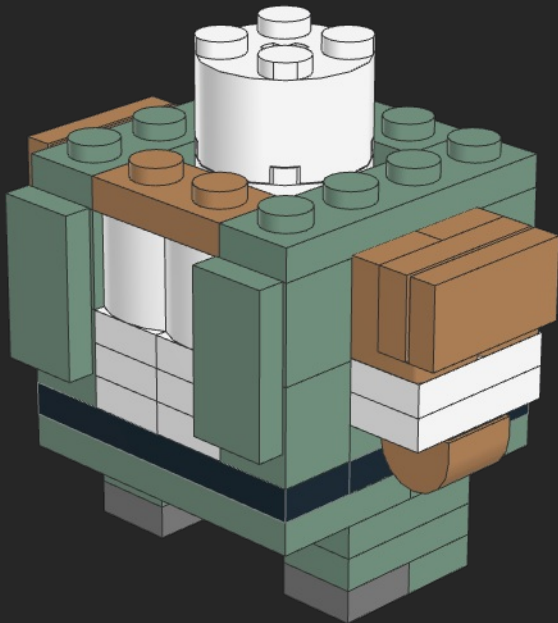
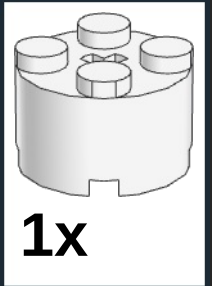

24

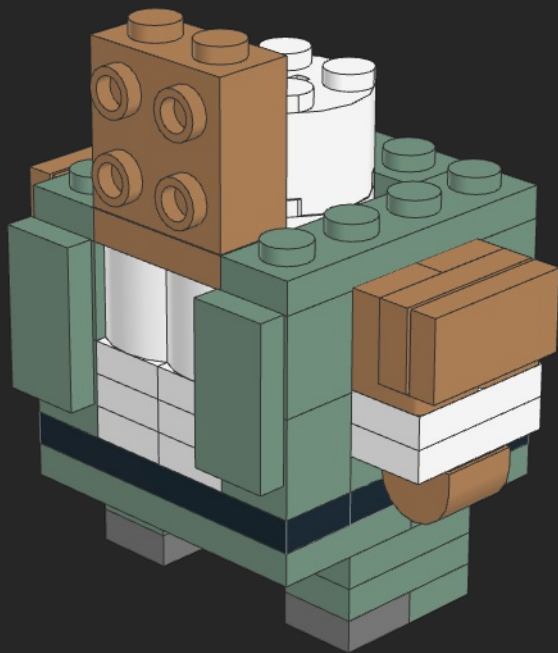
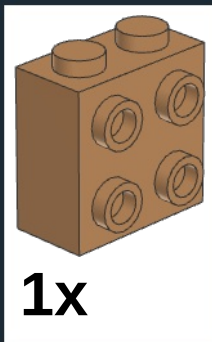

25

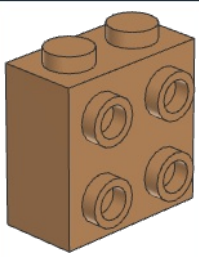

2x

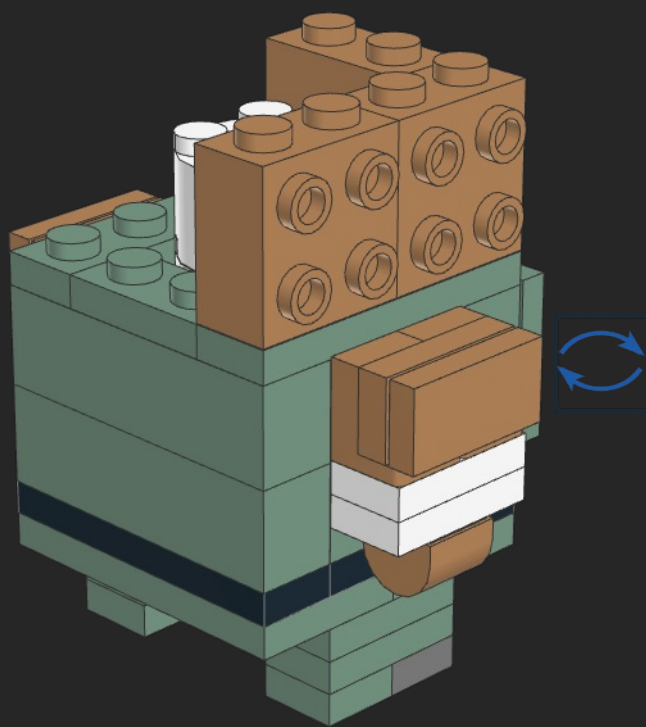

26

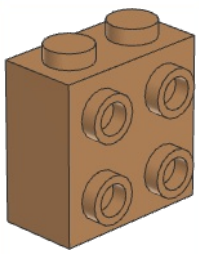

1x

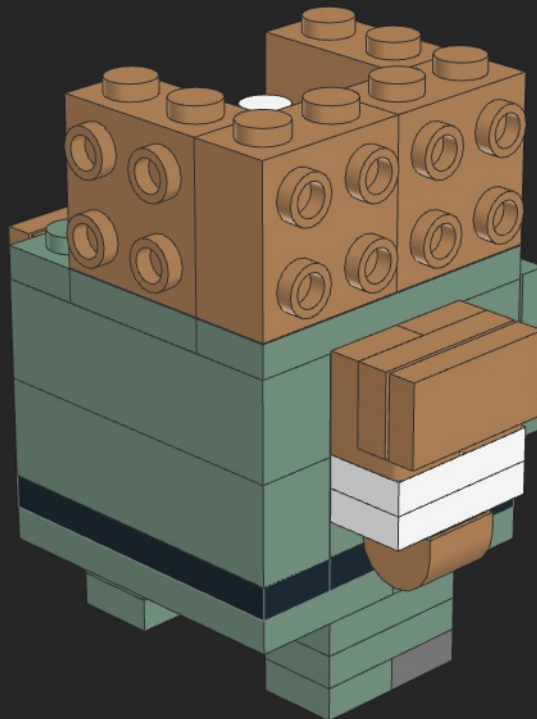

27

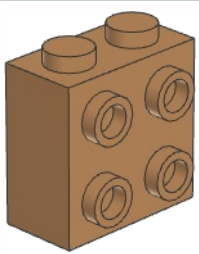

2x

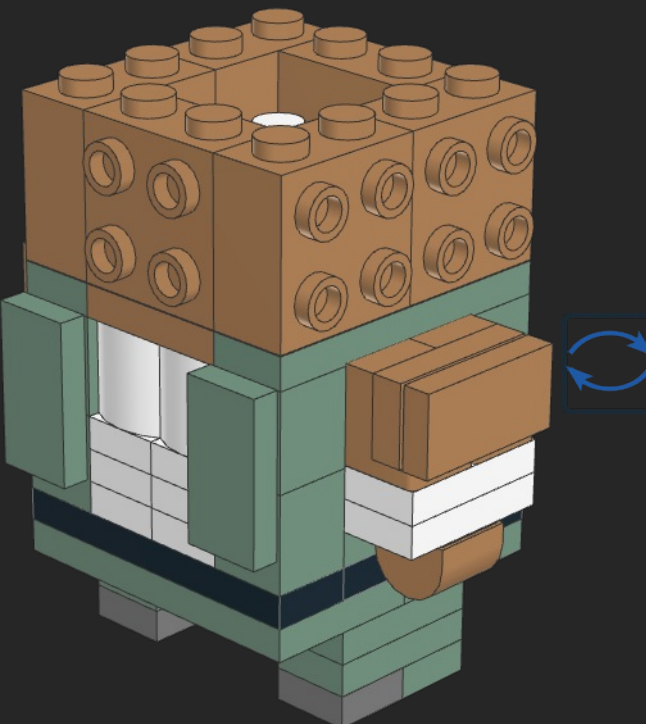

28

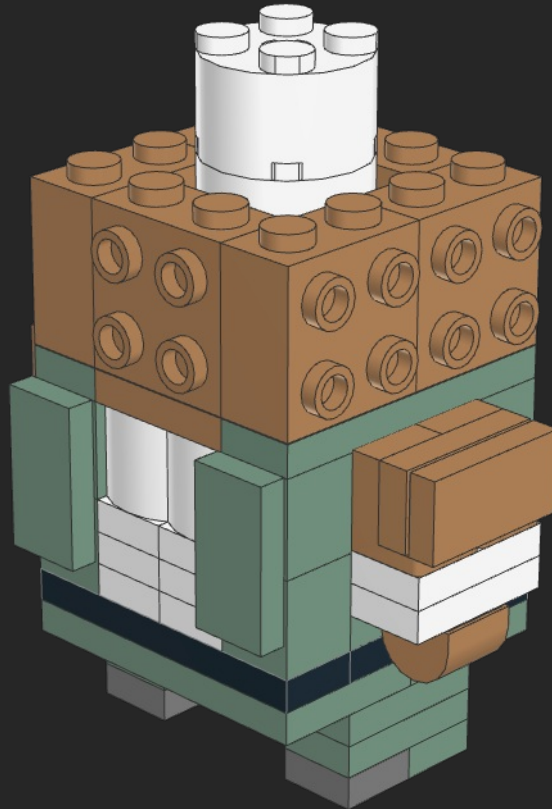
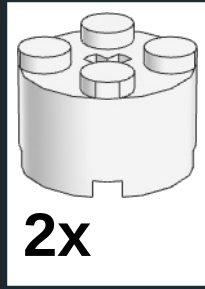

29

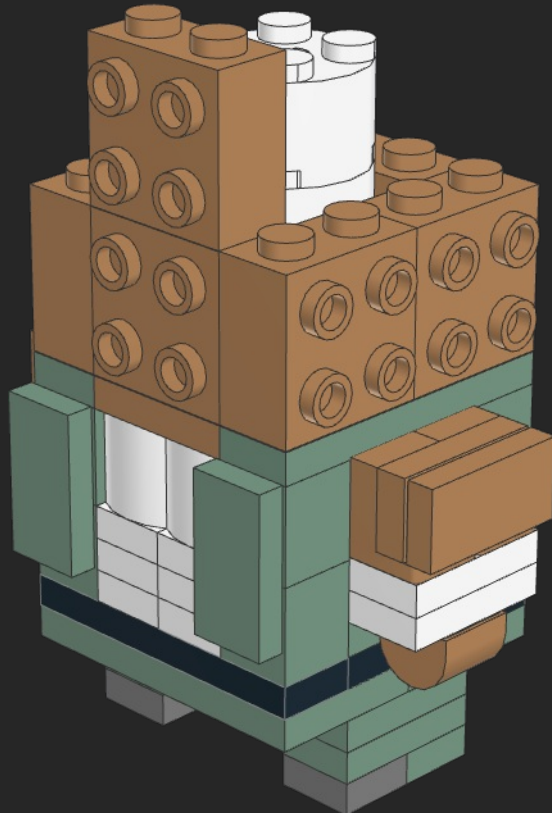
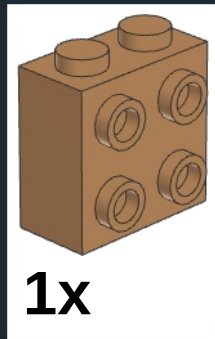

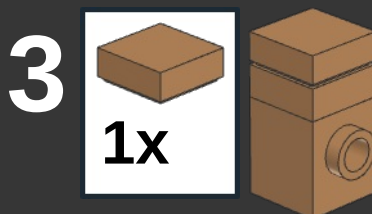
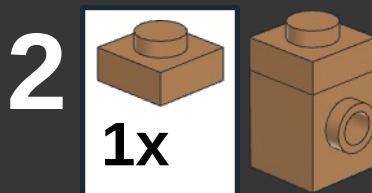
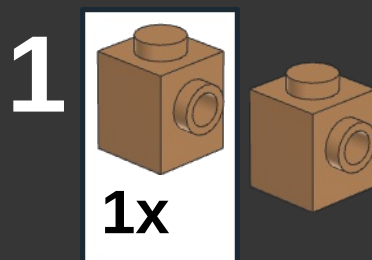

x2

30

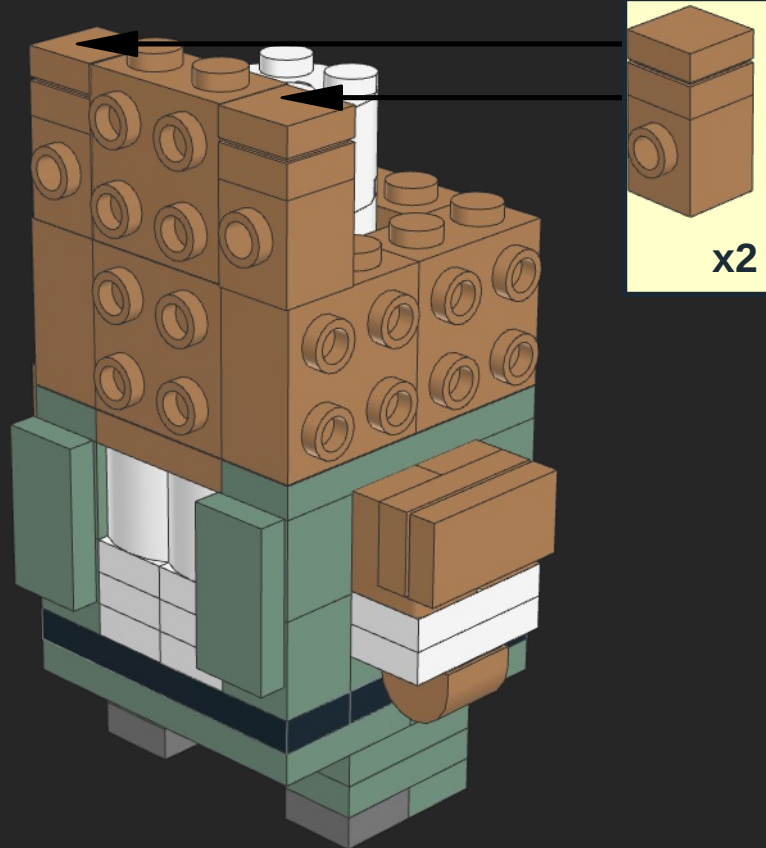

31

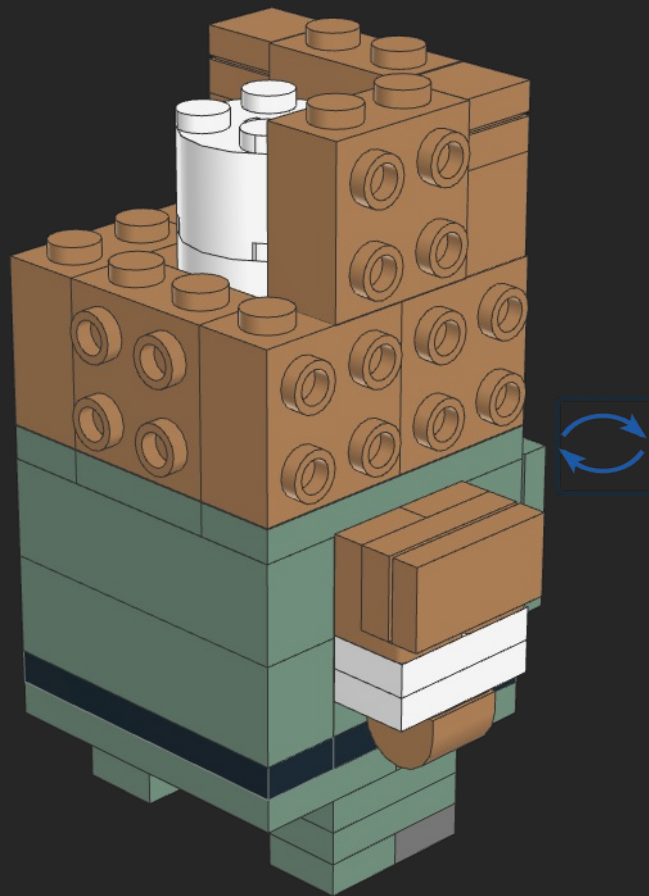
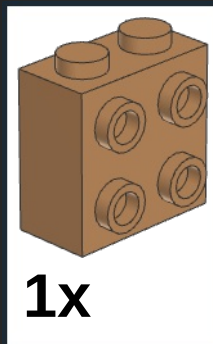

32

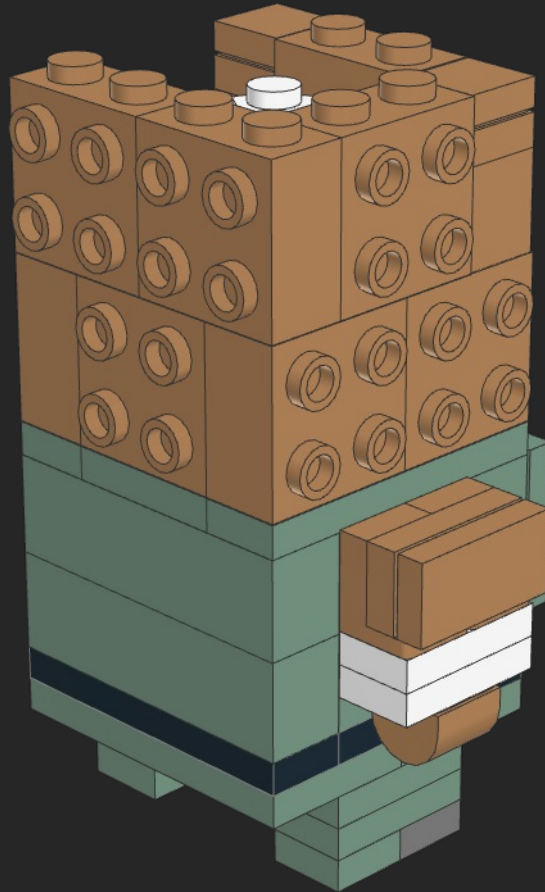
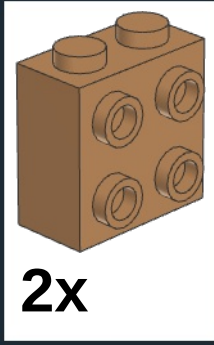

33

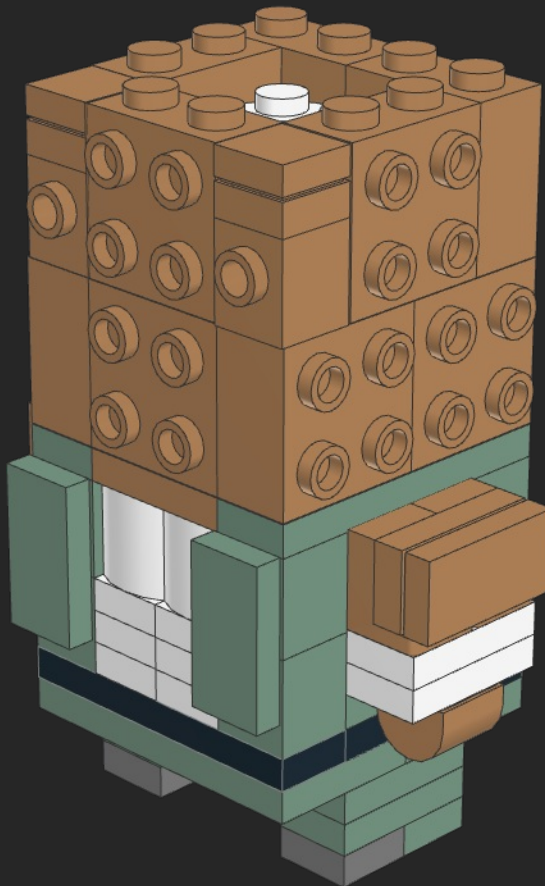
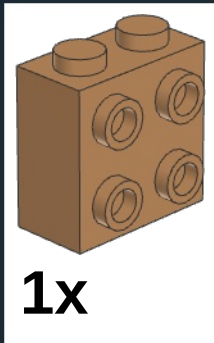

34

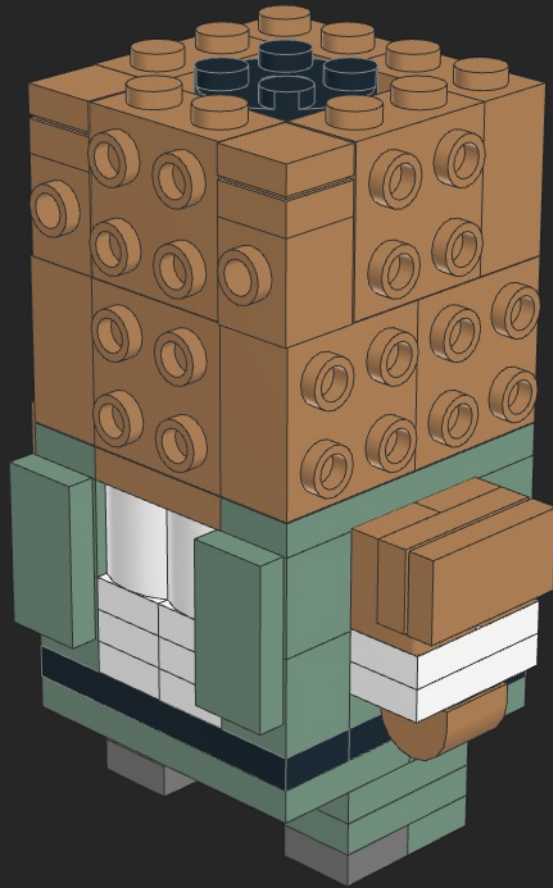
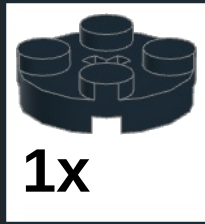

35

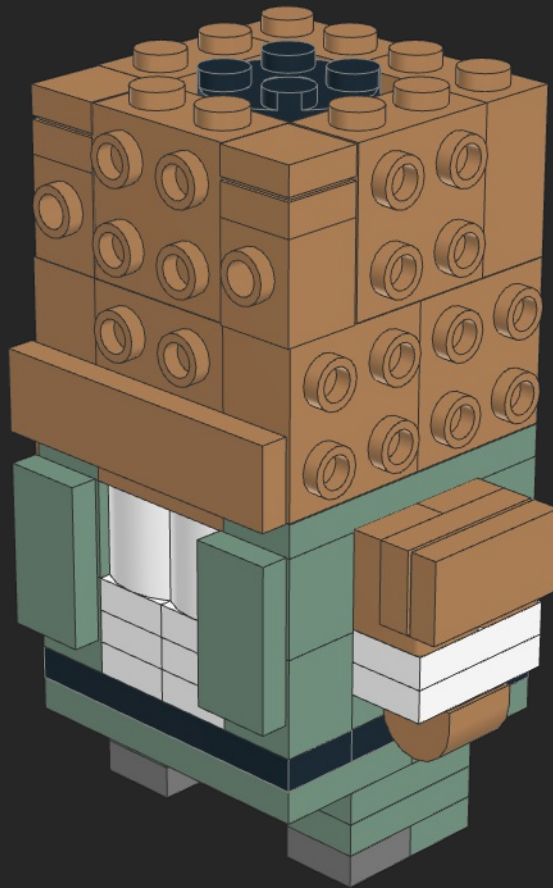
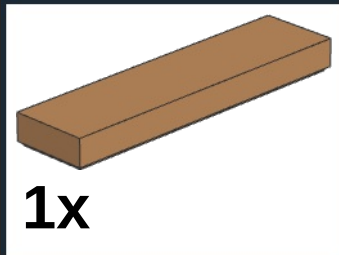

36

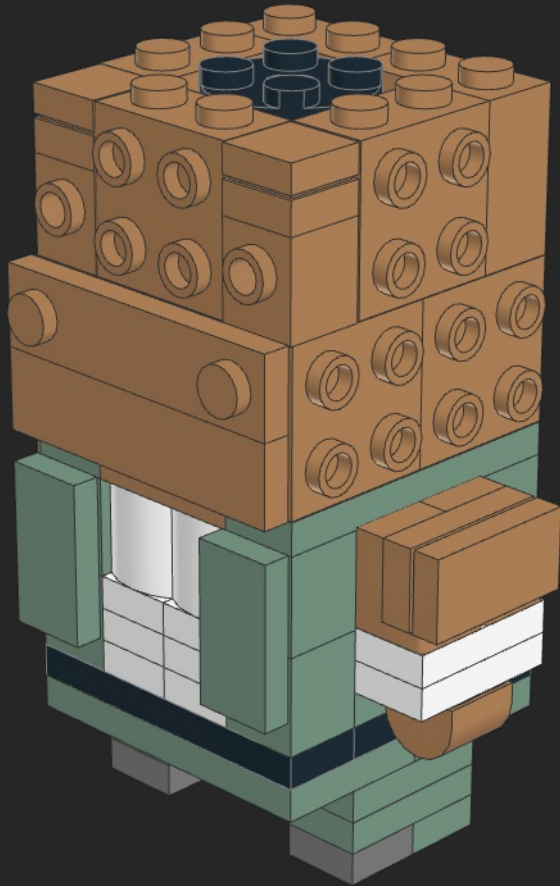
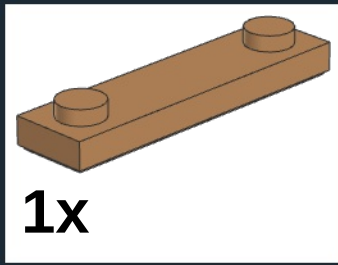

37

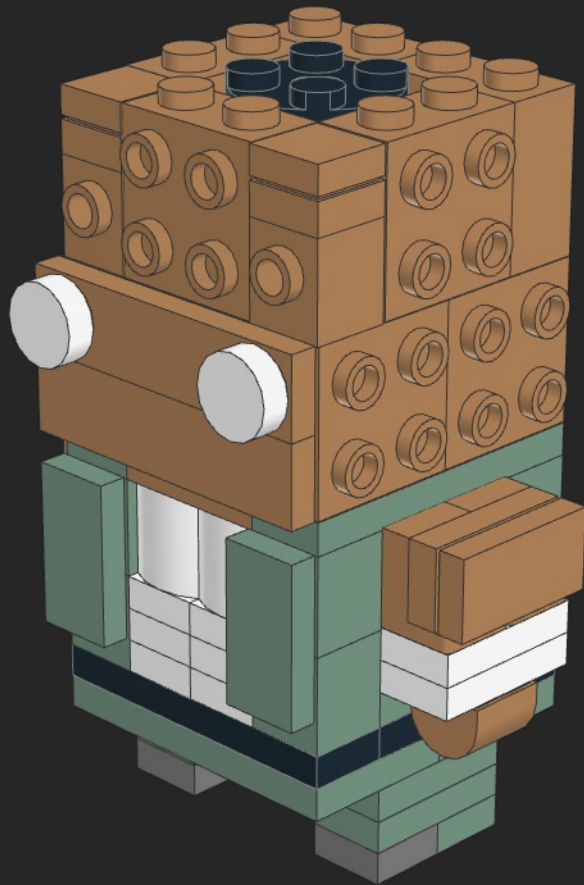

38

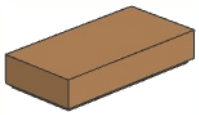

1x

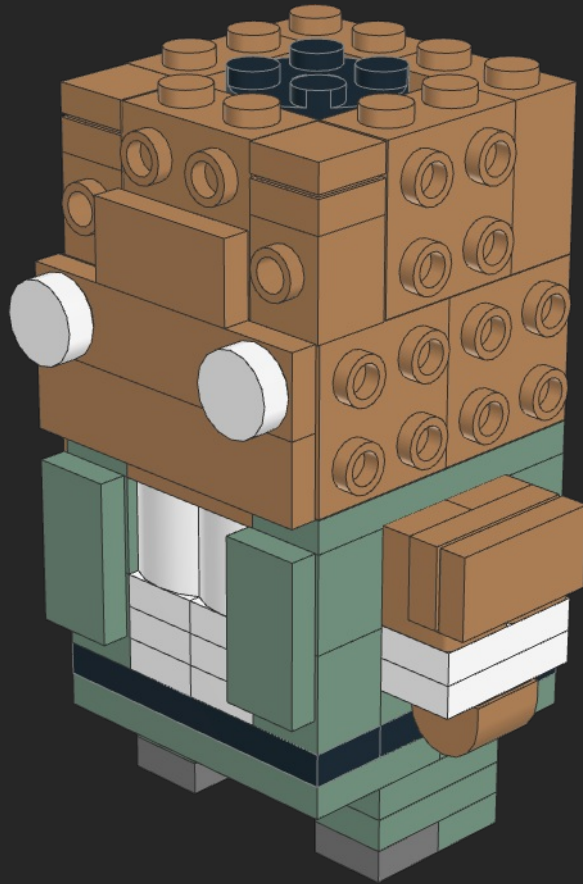

39

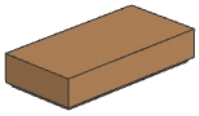

2x

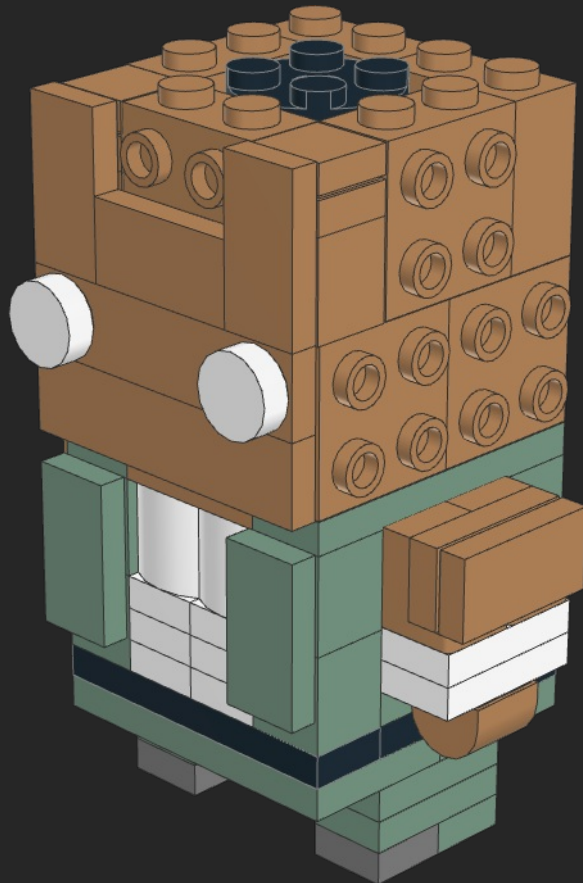

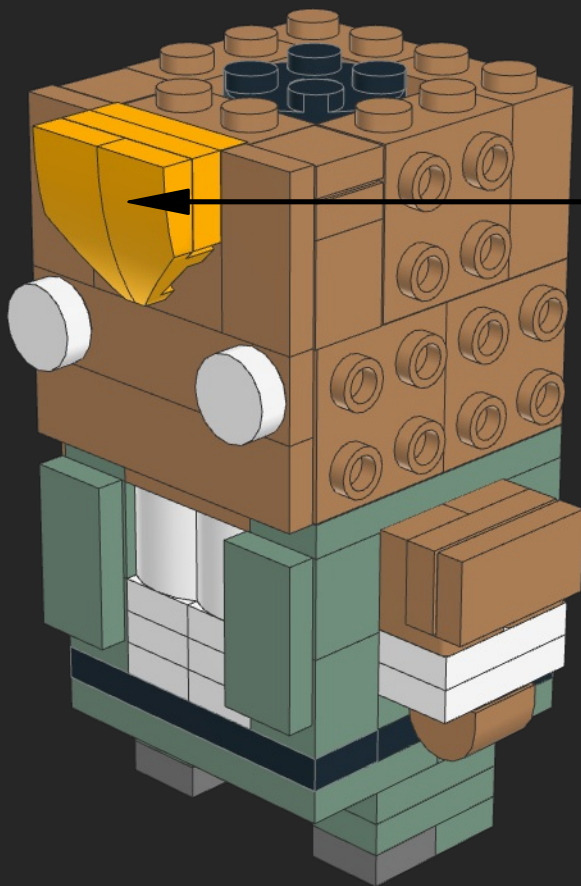

1

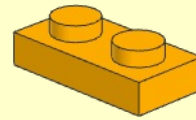
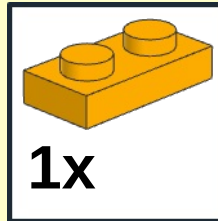

2

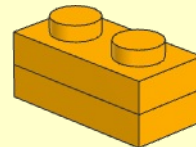
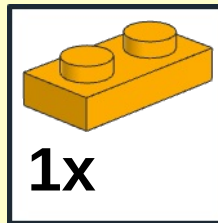

3

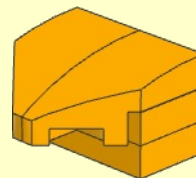
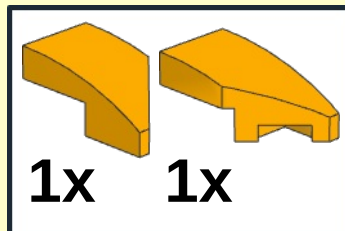

1

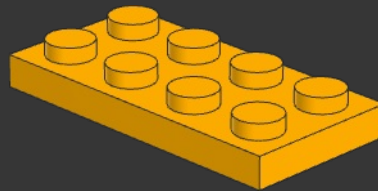
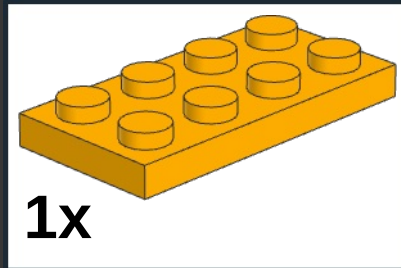

2

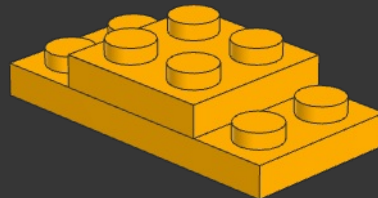
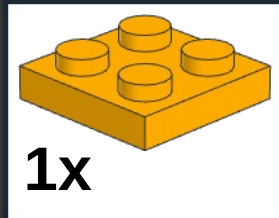

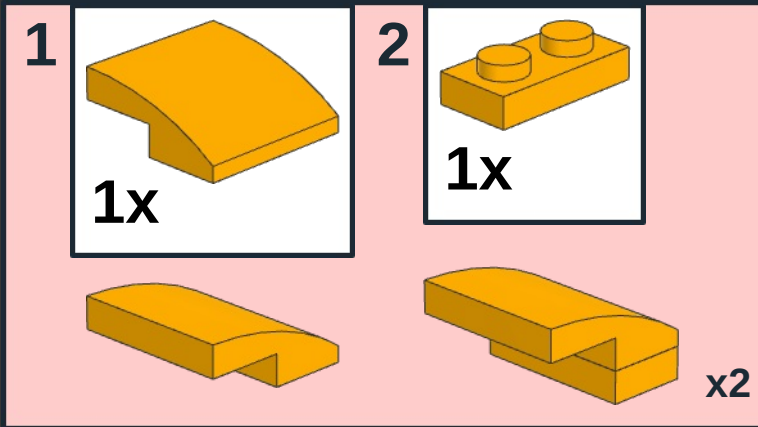

3

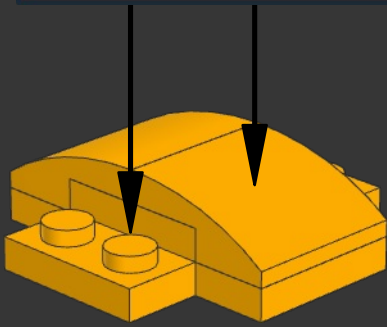

4

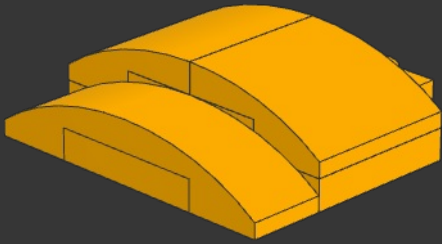

5

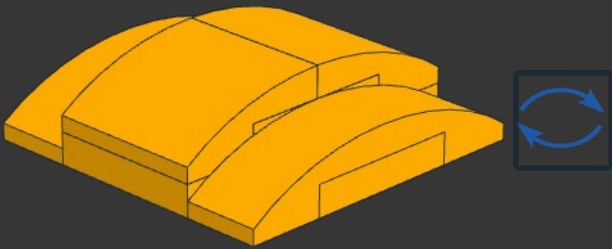

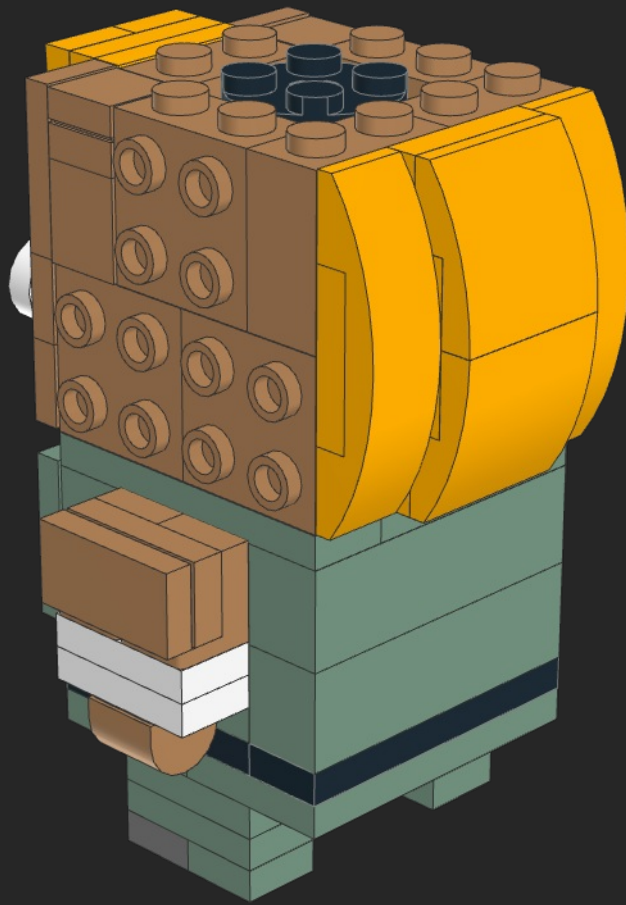

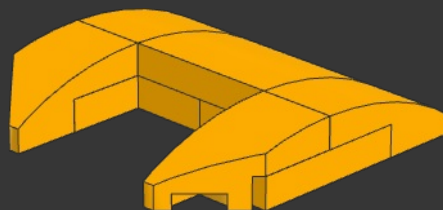
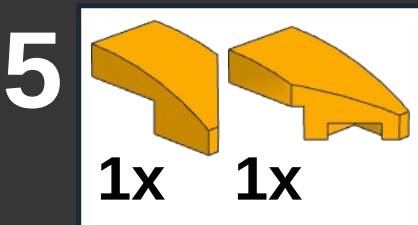
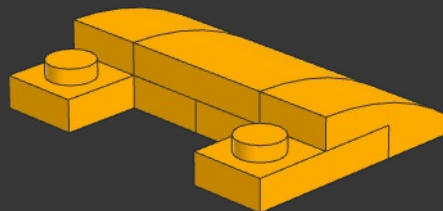
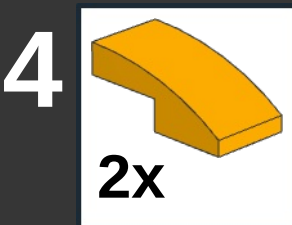
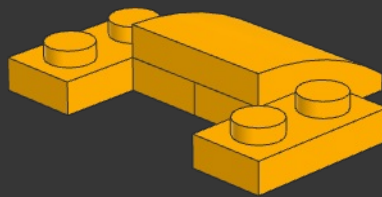
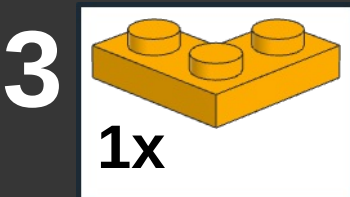
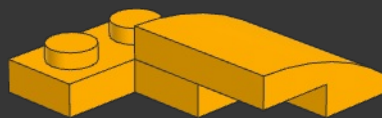
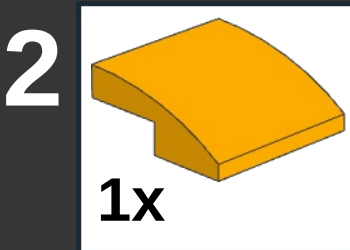
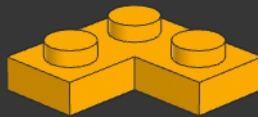
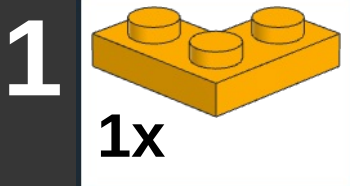

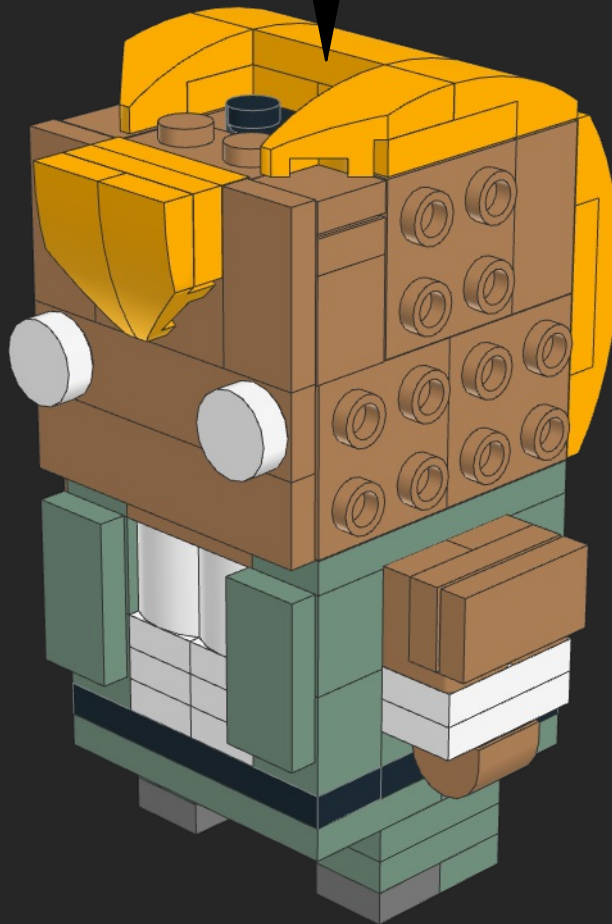
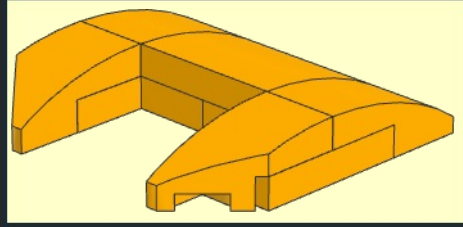

1

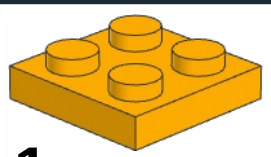

1x

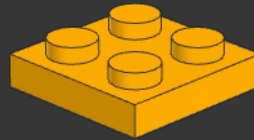

2

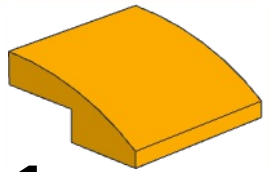

1x

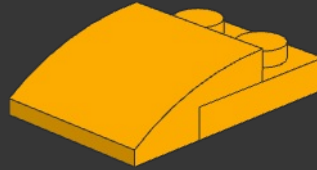

3

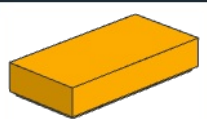

1x

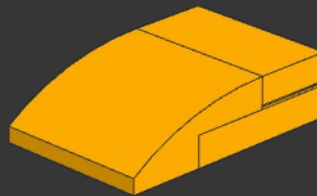

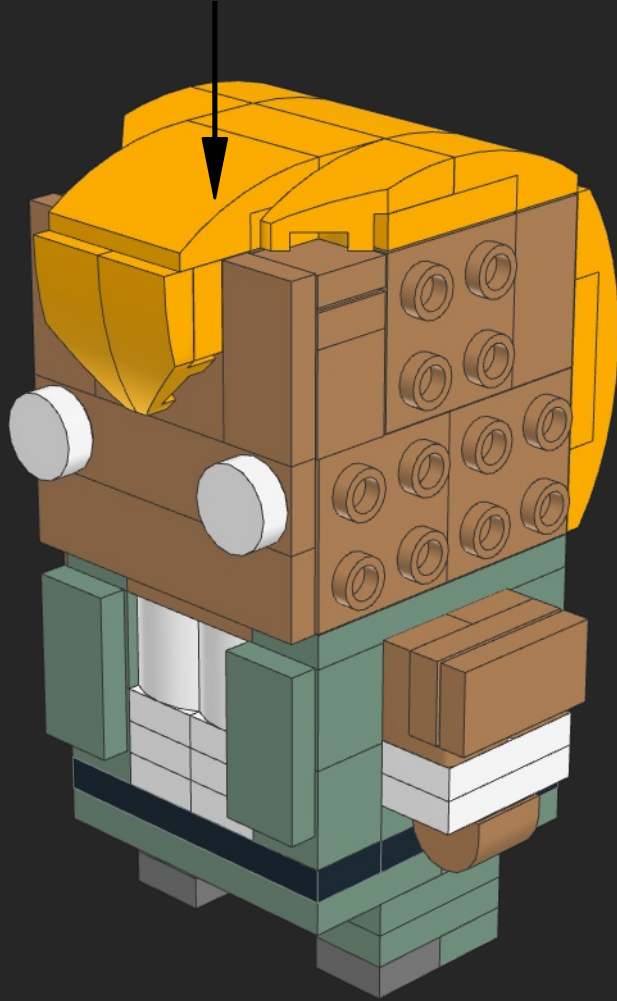
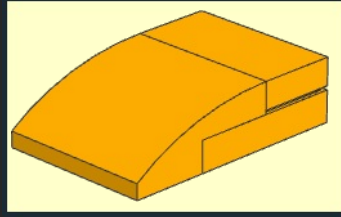

44

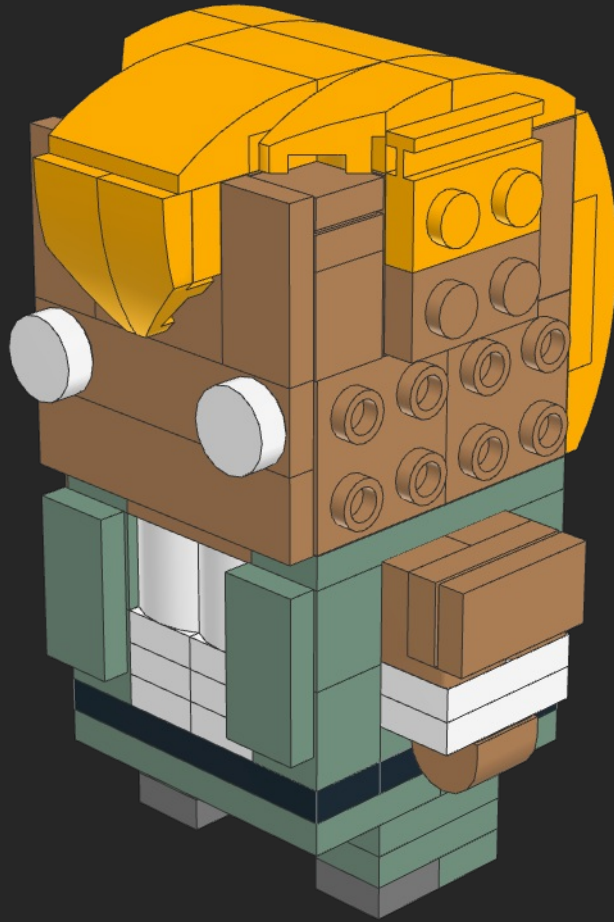
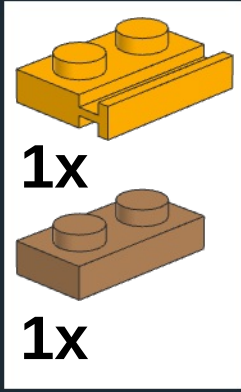

45

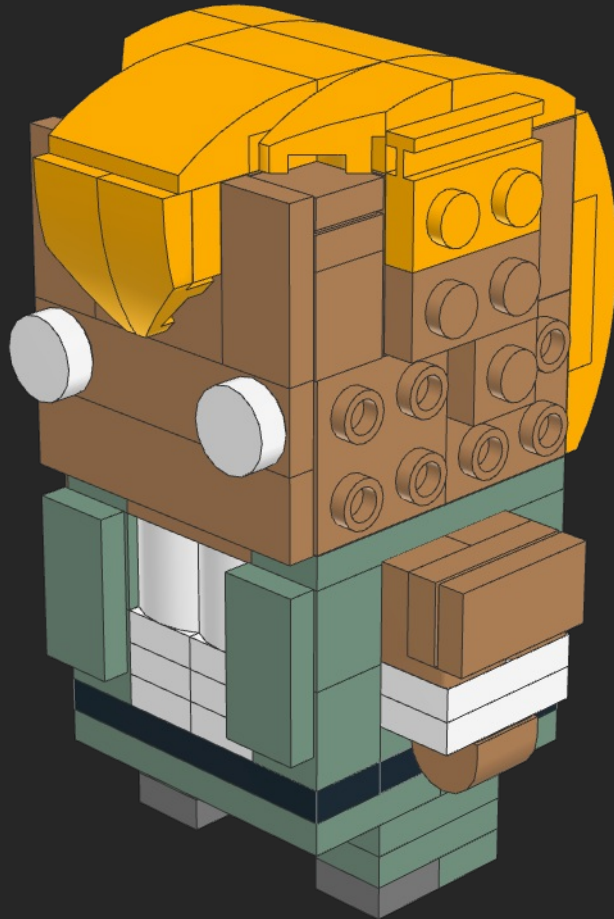
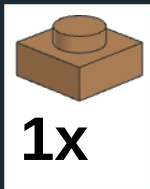

46

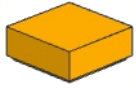

1x



1x

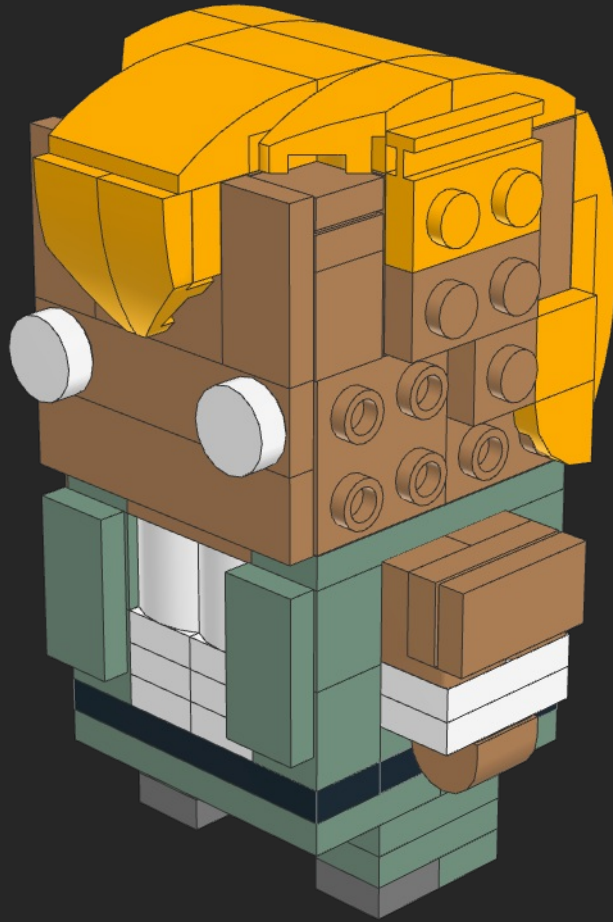

47

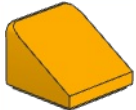

1x

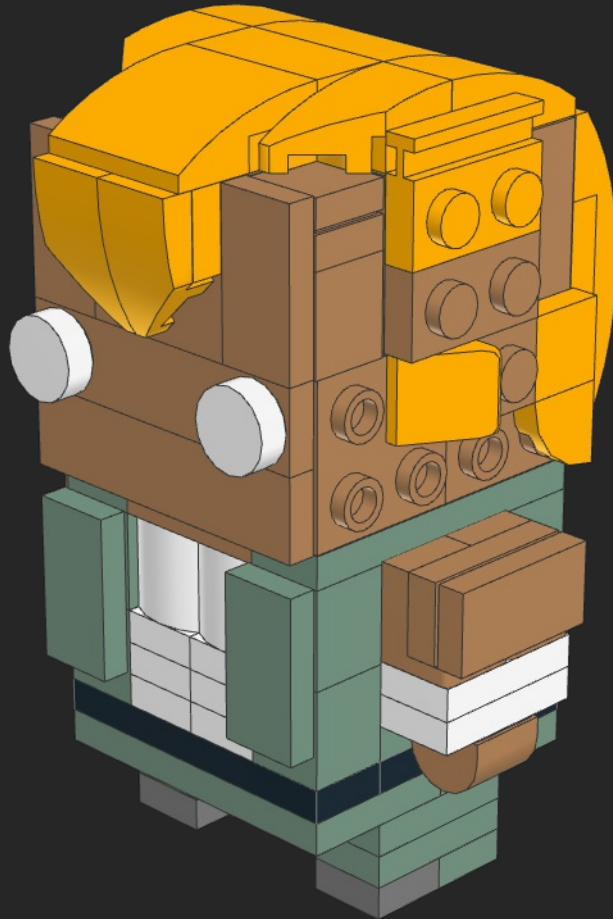

48

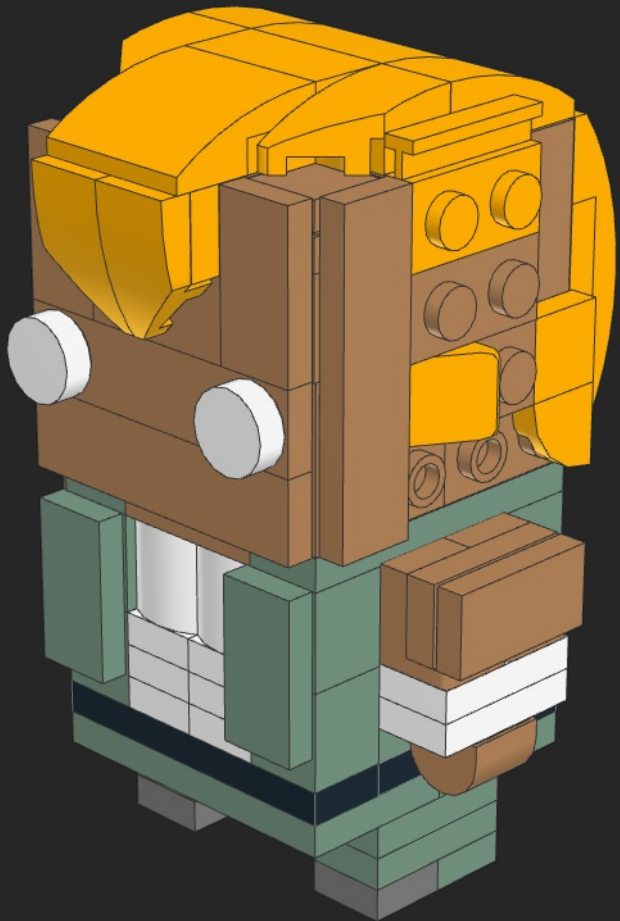
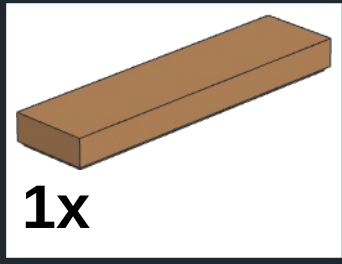

49

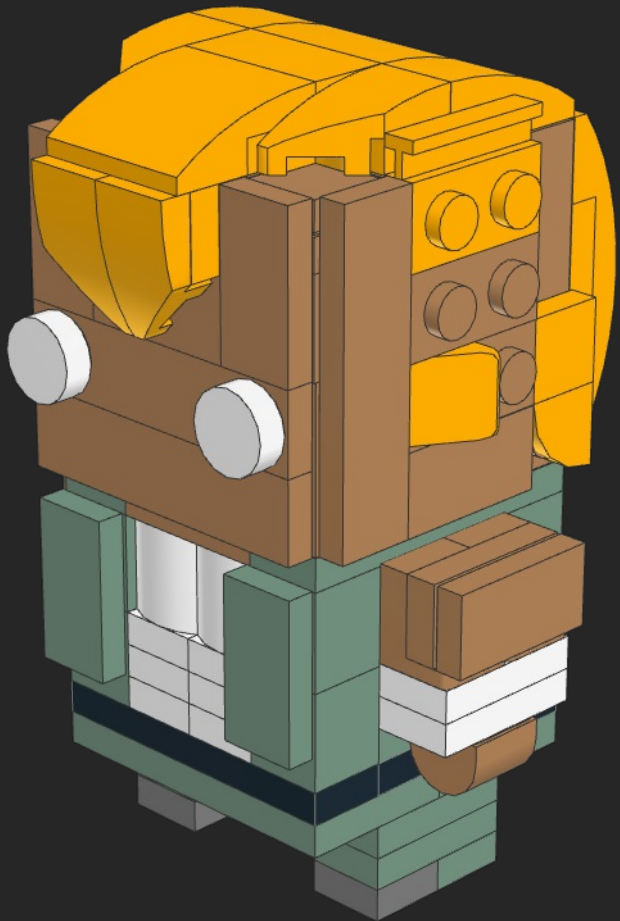
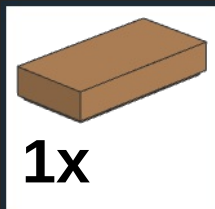

50

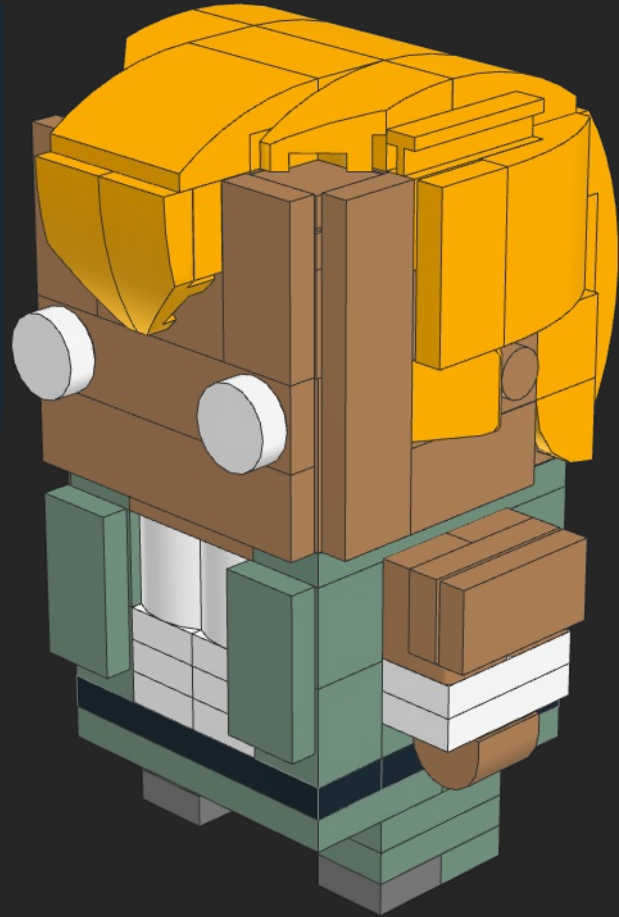
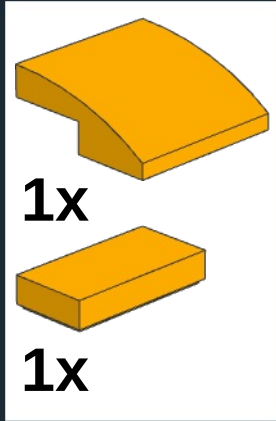

51

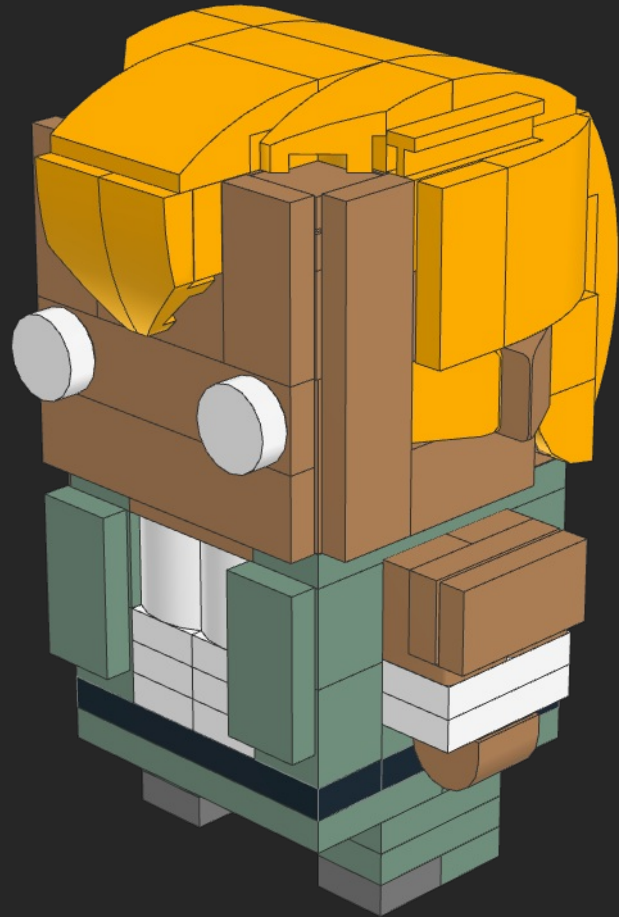
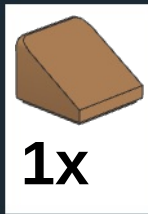

52

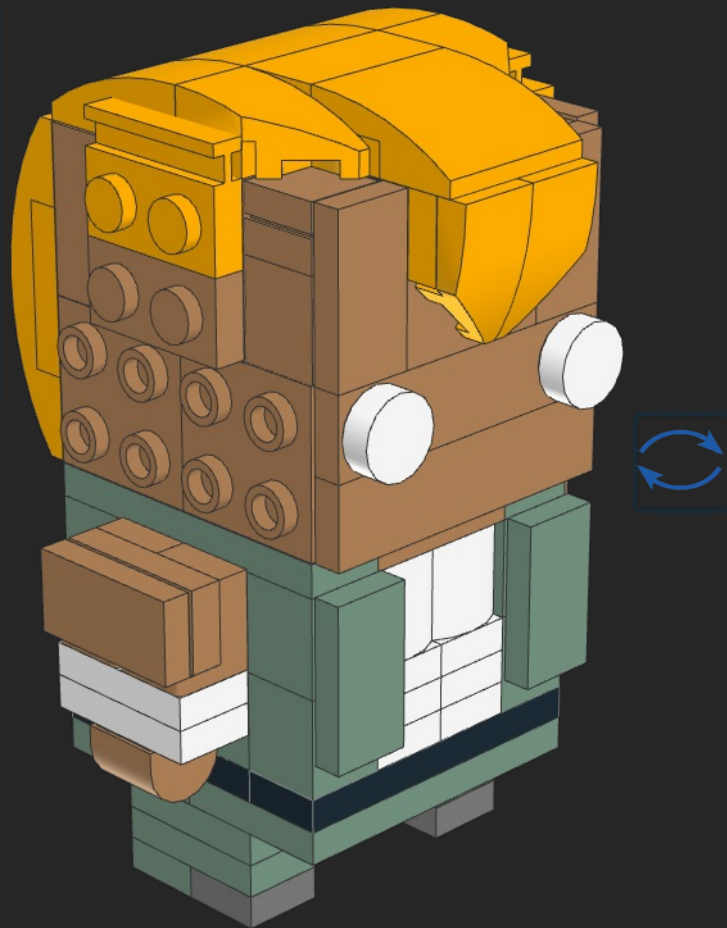
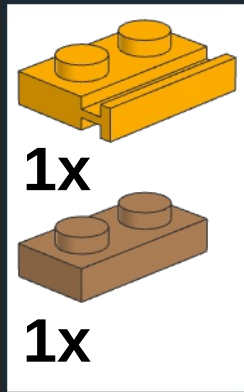

53

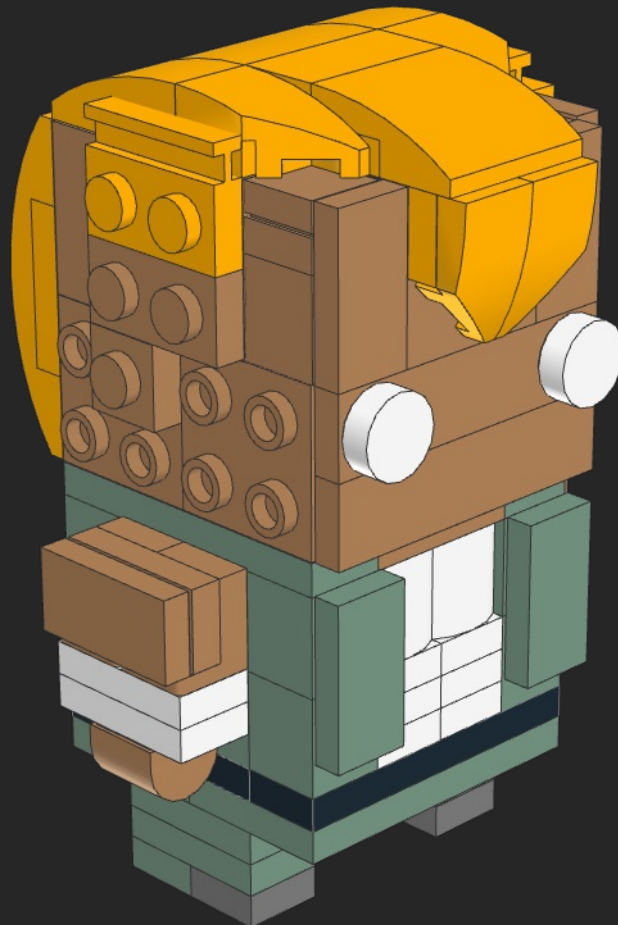
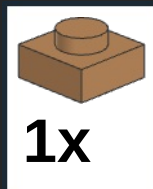

54

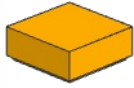

1x



1x

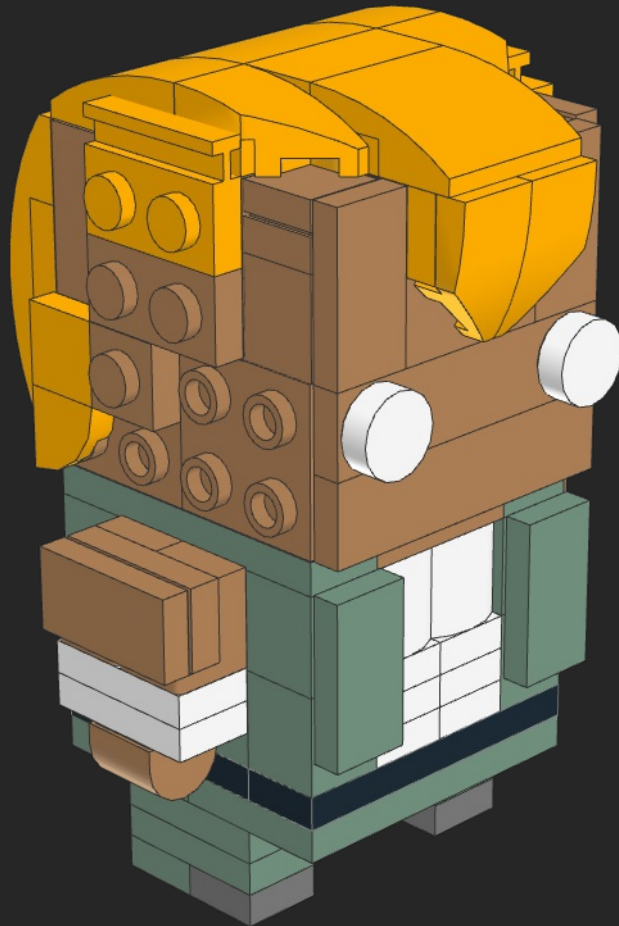

55



1x

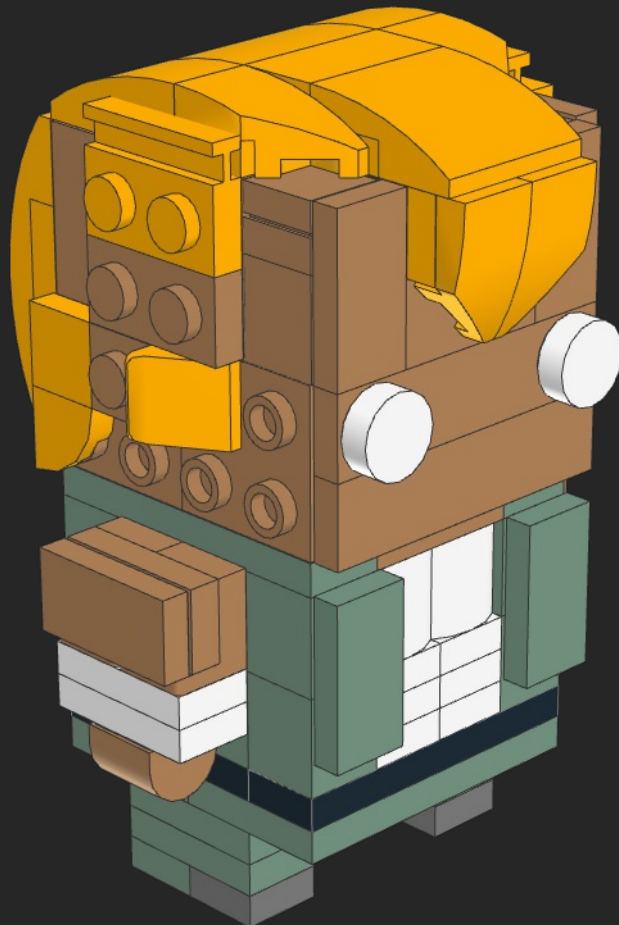

56

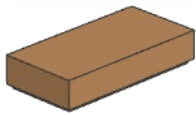

1x

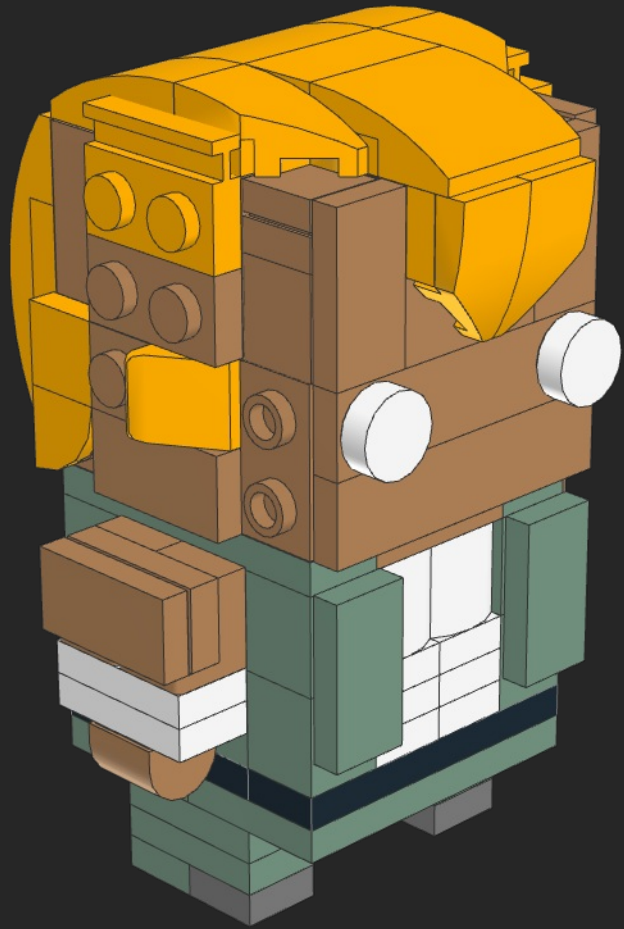

57

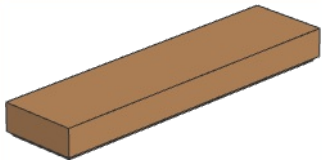

1x

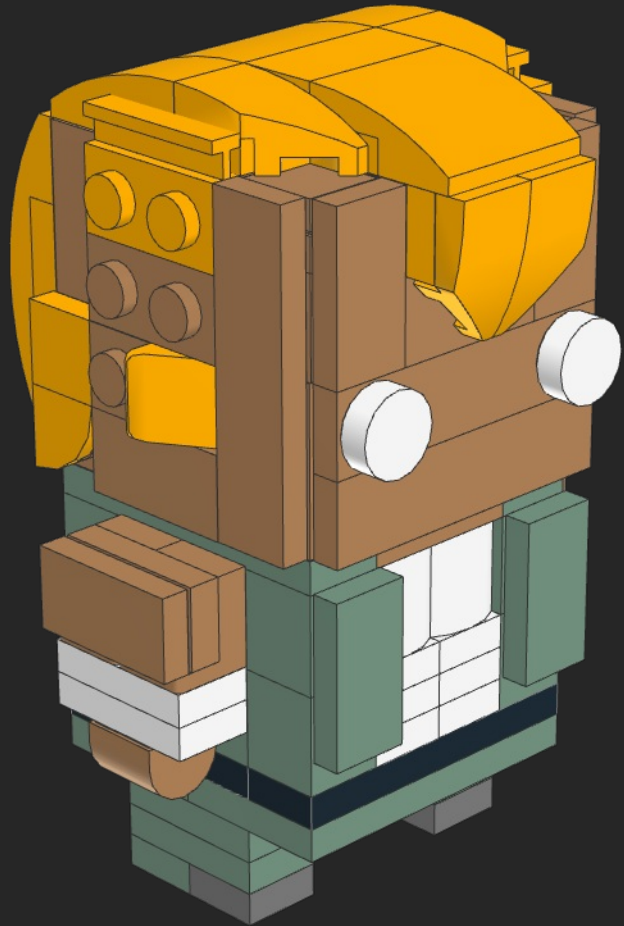

58

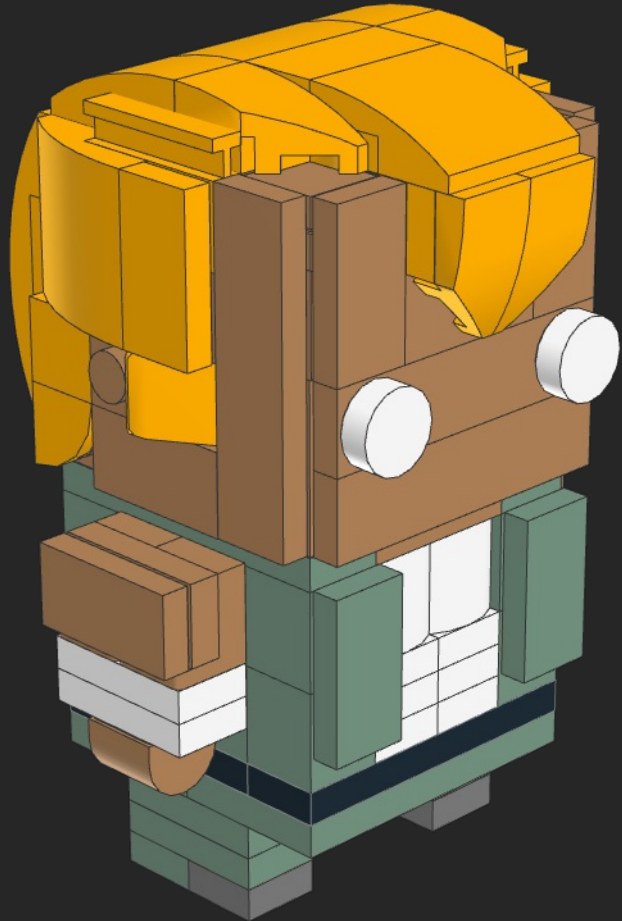
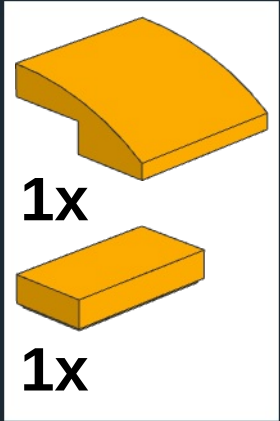

59

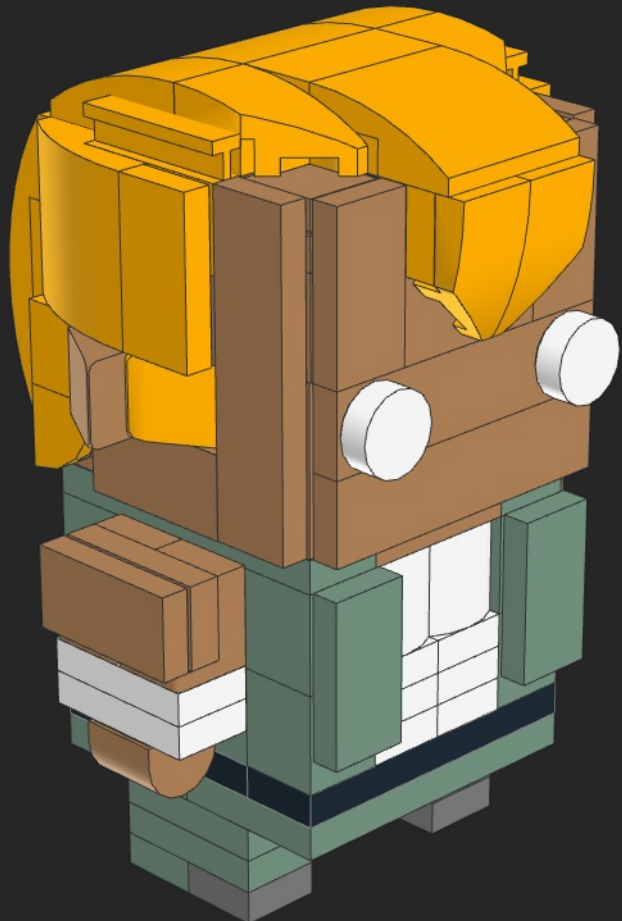
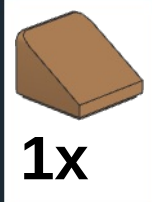



7x



2x

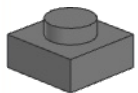

2x

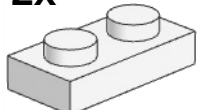

2x

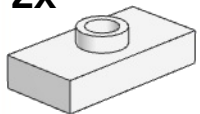

2x

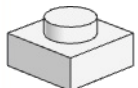

6x

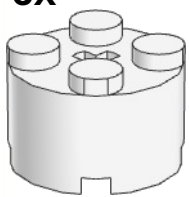

5x

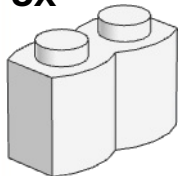

1x



2x

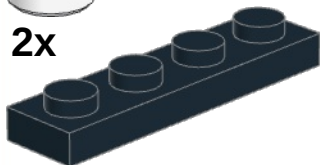

2x

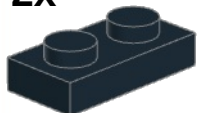

2x



3x

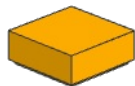

2x



2x

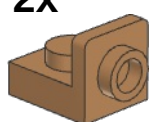

4x



2x

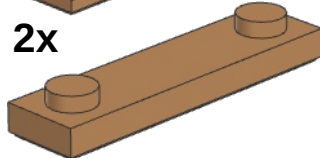

1x

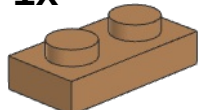

5x

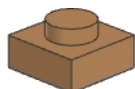

4x

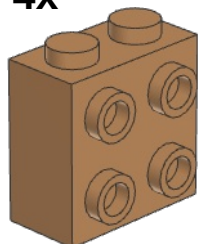

11x

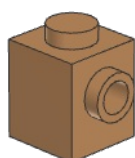

2x



2x

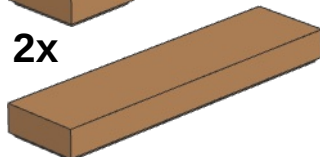

3x

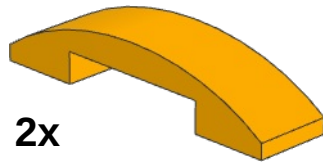

2x

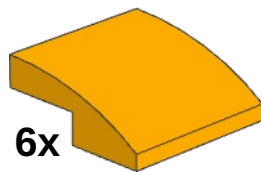

6x

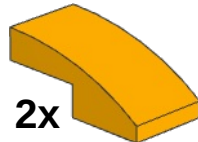

2x



2x

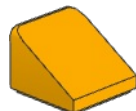

2x

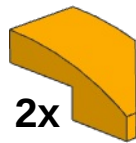

2x

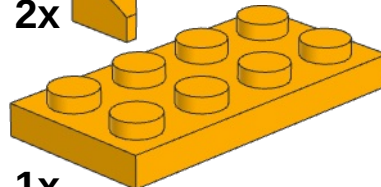

1x

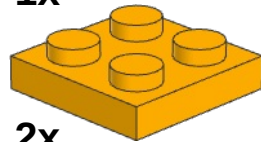

2x

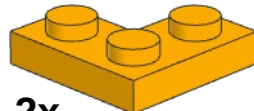

2x

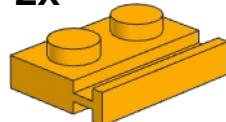

2x

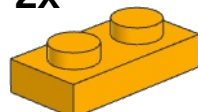

4x

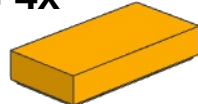

3x

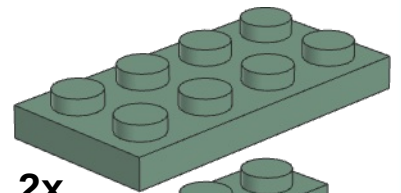

2x

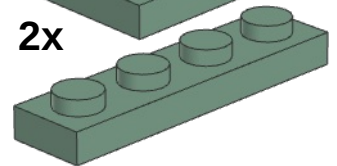

2x

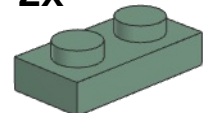

5x

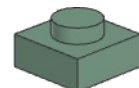

2x

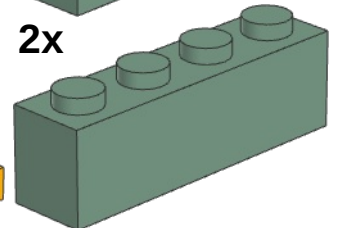

2x

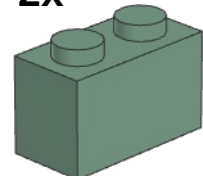

2x

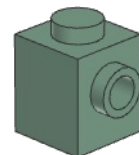

6x

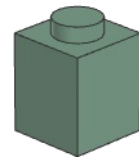

2x

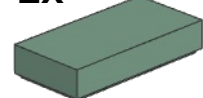

2x

Honorable mentions of contributors:

Teg12345



Hope you had fun with this model and instructions.

As always you can reach out to me via email:

birdbrickbuilds@gmail.com

You can also check my work on rebrickable and instagram:

<https://rebrickable.com/users/birdbrickbuilds/>

<https://www.instagram.com/birdbrickbuilds/>

If you wish to help me continue to make this models and instructions you can buy me a coffee to help me stay up late:

<https://www.buymeacoffee.com/birdbrickbl>

Or you can buy my Coffee Espresso MOC:

<https://reb.li/m/118798>

Or even you can buy my Beer Mug MOC:

<https://reb.li/m/137364>



This work is licensed under a [Creative Commons Attribution-NonCommercial-ShareAlike 4.0 International License](https://creativecommons.org/licenses/by-nc-sa/4.0/).