

DEATH STAR VS ALDERAAN

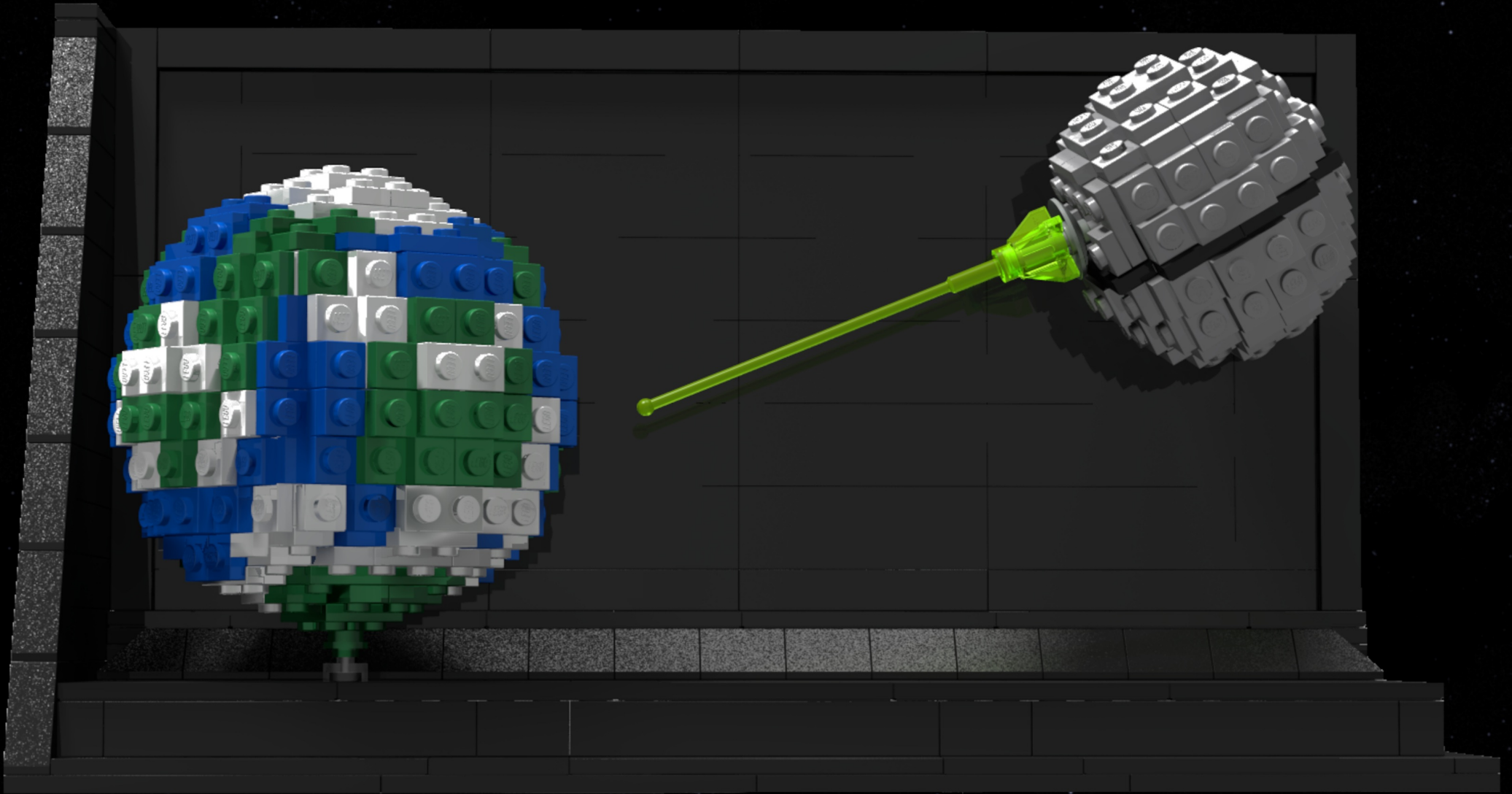

Model instructions by Eduardo Sousa
595 Parts
Diorama of the last moments of Alderaan



Attribution-NonCommercial-ShareAlike 4.0 International (CC BY-NC-SA 4.0)

This is a human-readable summary of (and not a substitute for) the [license](#). [Disclaimer](#).

You are free to:

Share — copy and redistribute the material in any medium or format

Adapt — remix, transform, and build upon the material

The licensor cannot revoke these freedoms as long as you follow the license terms.

Under the following terms:



Attribution — You must give [appropriate credit](#), provide a link to the license, and [indicate if changes were made](#). You may do so in any reasonable manner, but not in any way that suggests the licensor endorses you or your use.



NonCommercial — You may not use the material for [commercial purposes](#).



ShareAlike — If you remix, transform, or build upon the material, you must distribute your contributions under the [same license](#) as the original.

No additional restrictions — You may not apply legal terms or [technological measures](#) that legally restrict others from doing anything the license permits.

Notices:

You do not have to comply with the license for elements of the material in the public domain or where your use is permitted by an applicable [exception or limitation](#).

No warranties are given. The license may not give you all of the permissions necessary for your intended use. For example, other rights such as [publicity, privacy, or moral rights](#) may limit how you use the material.

1

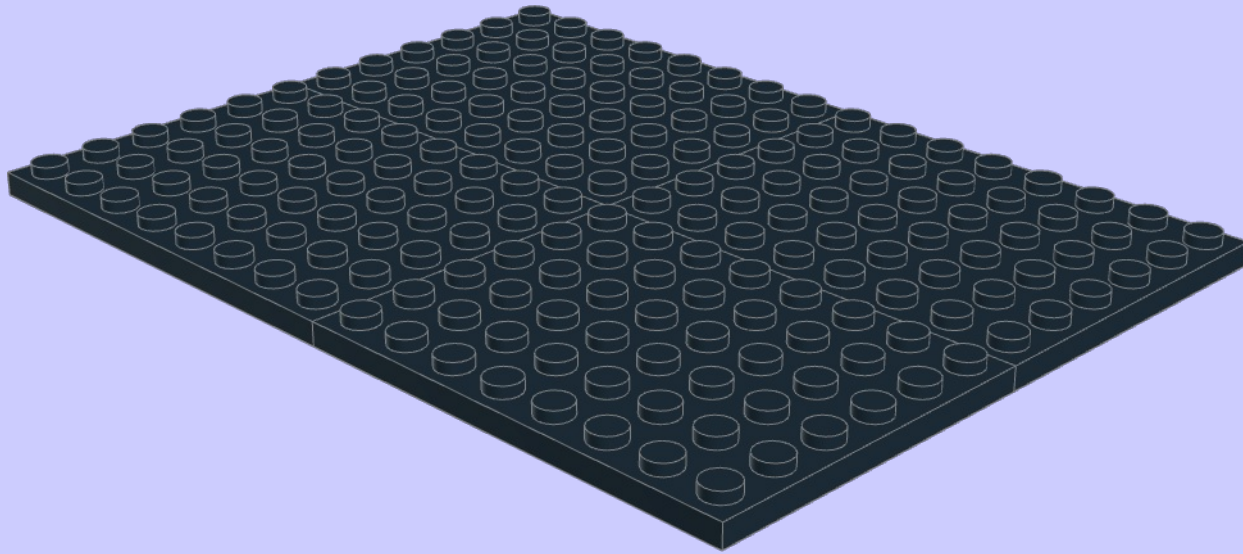
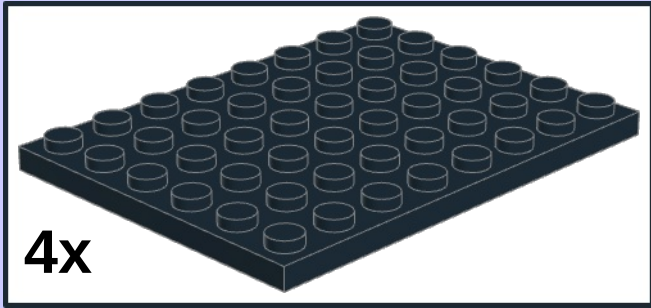

2

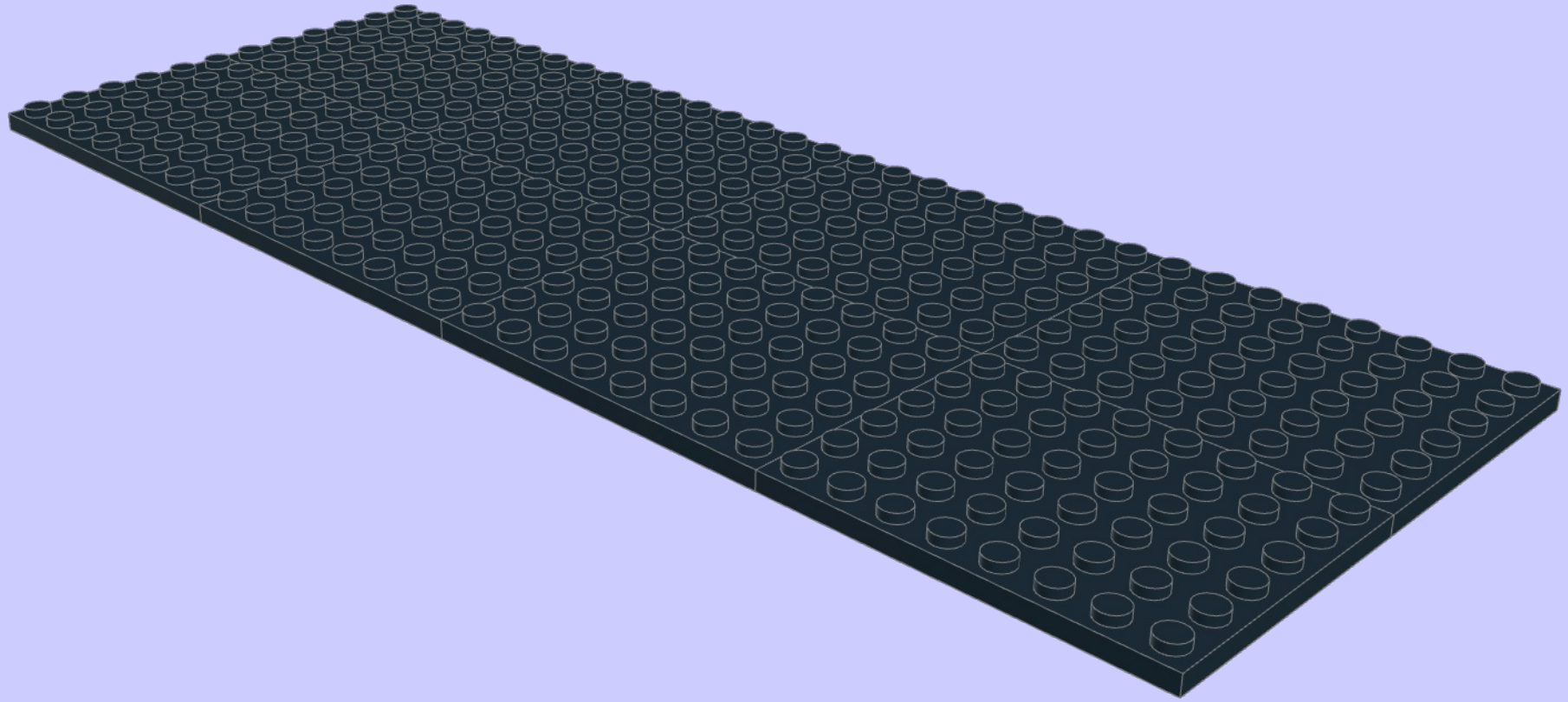
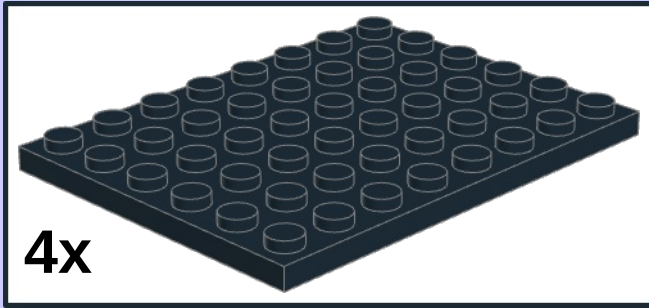

3

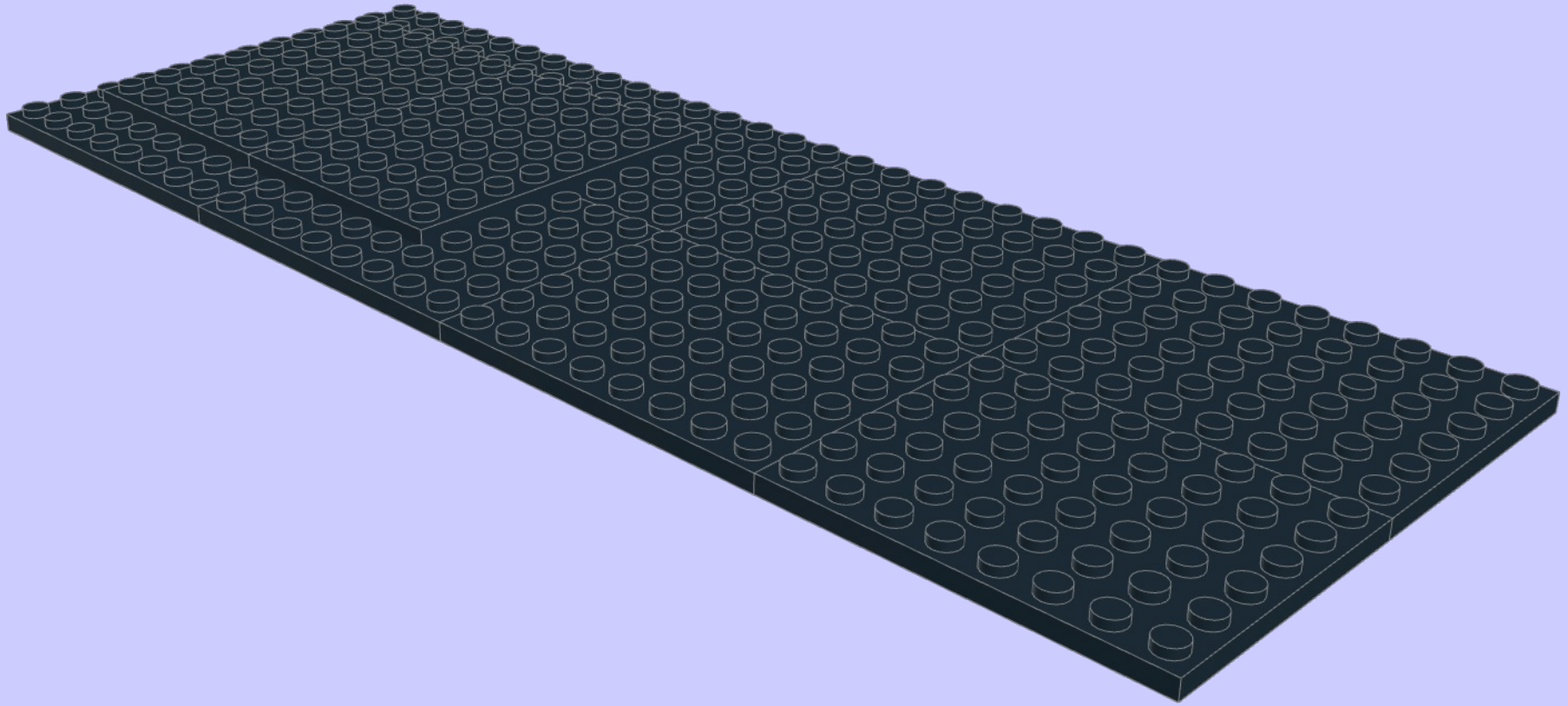
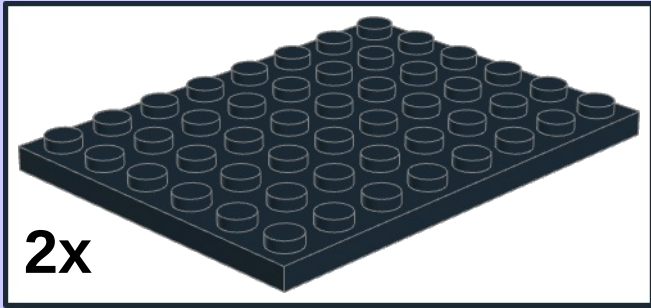

4

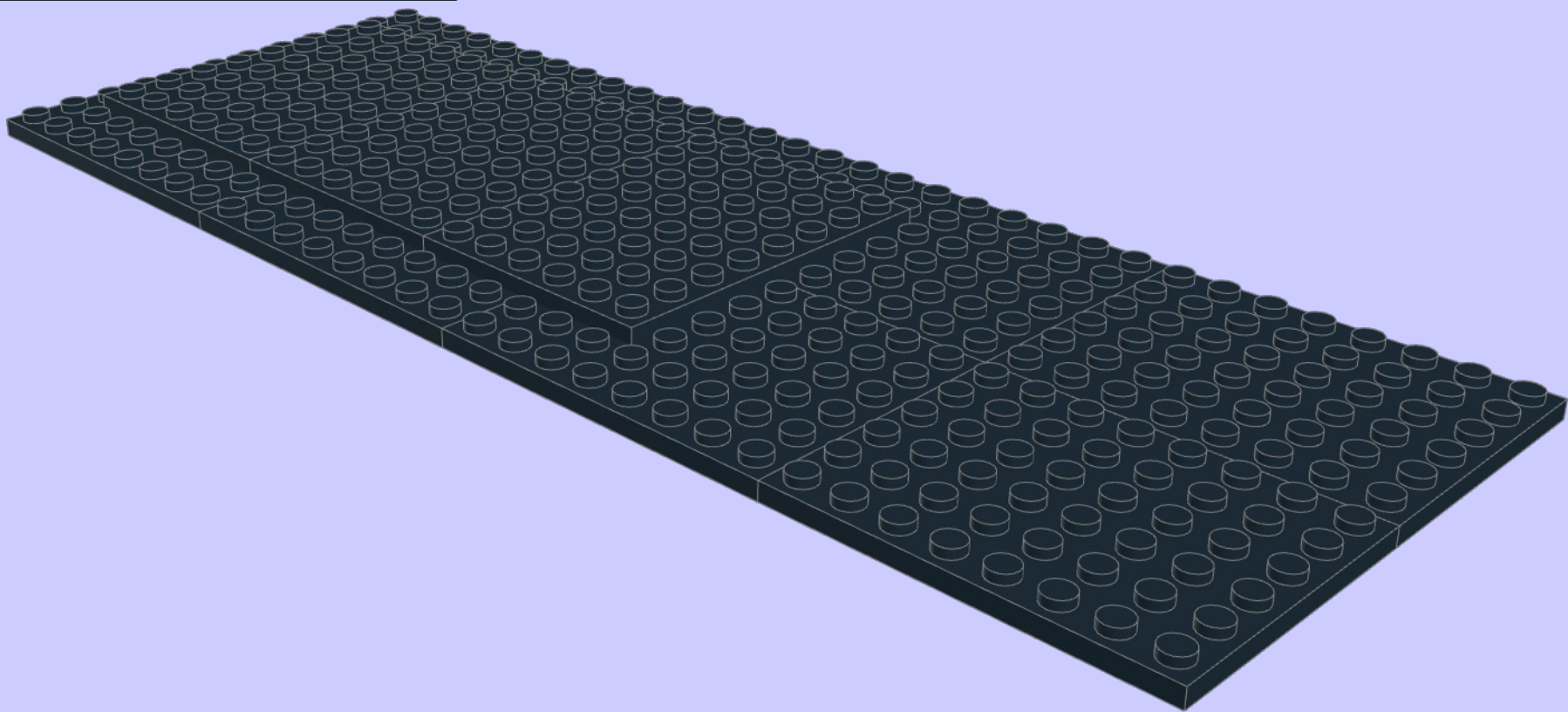
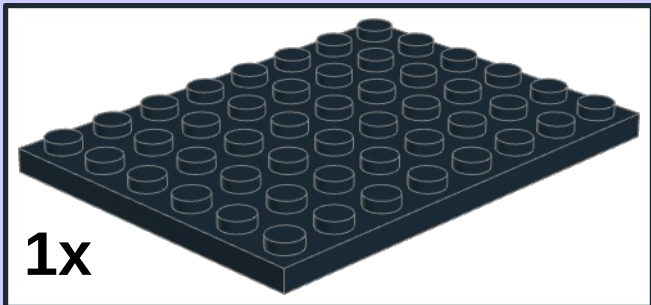

5

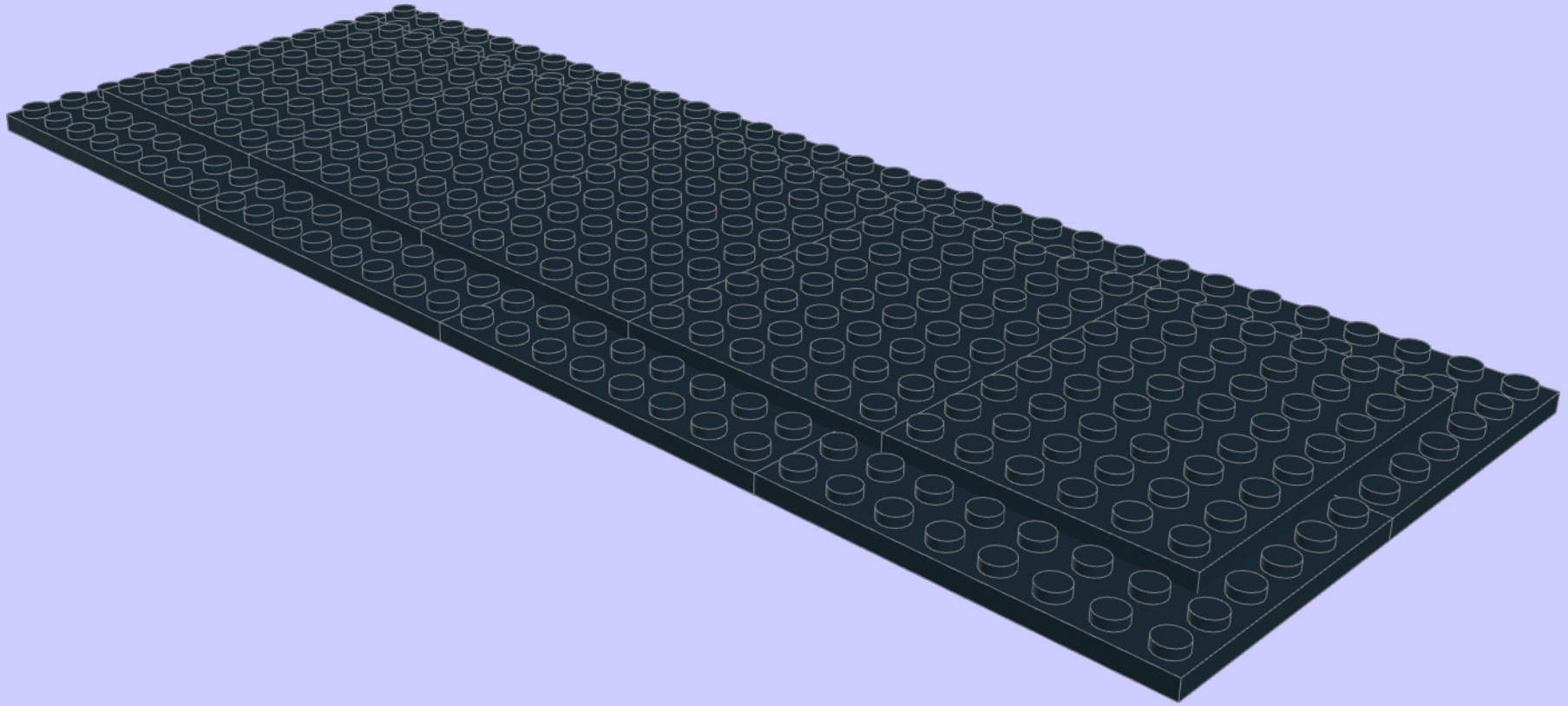
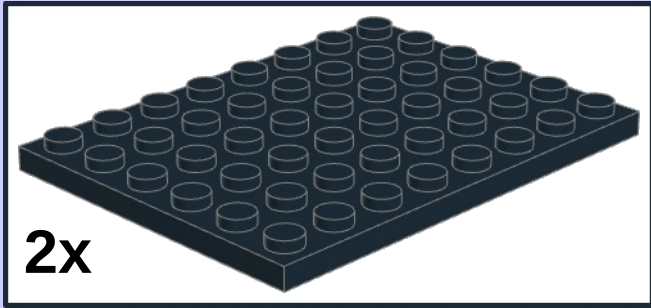

6

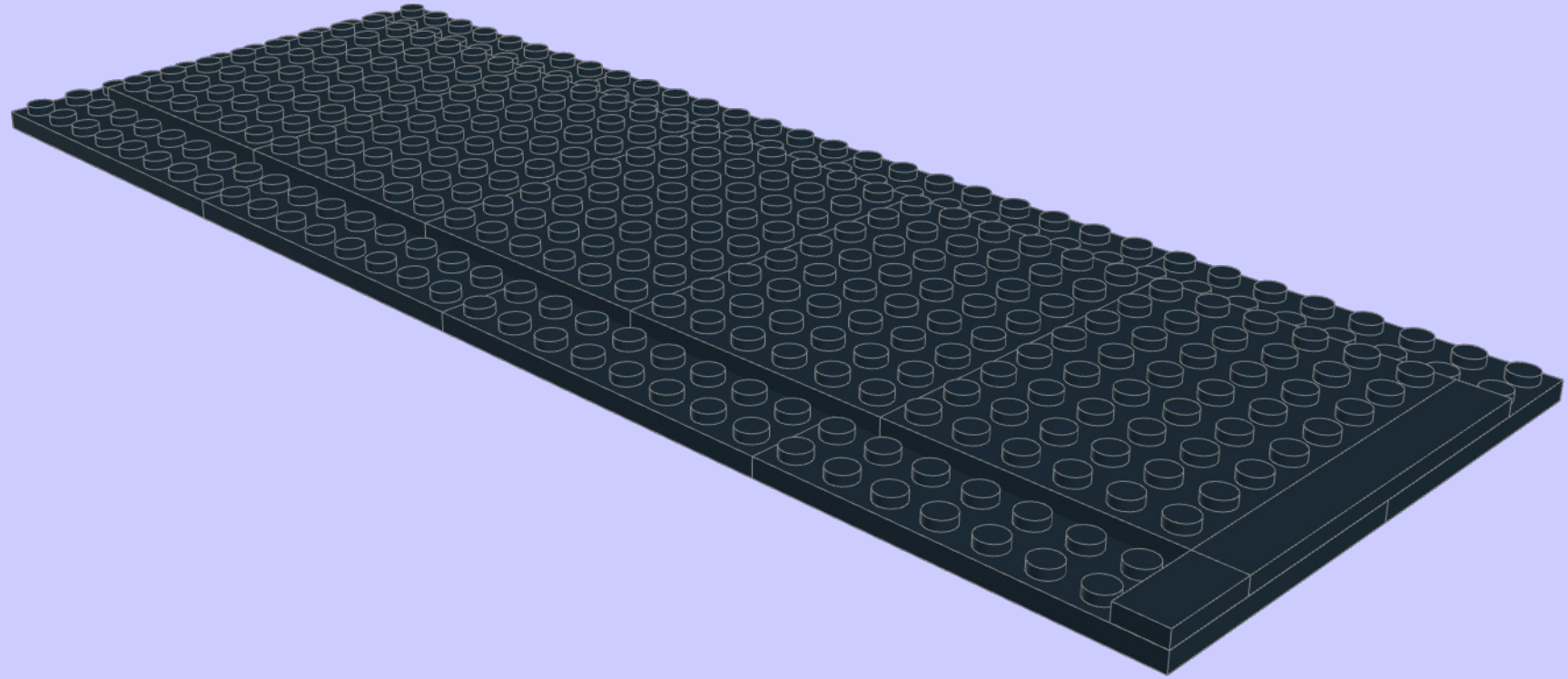
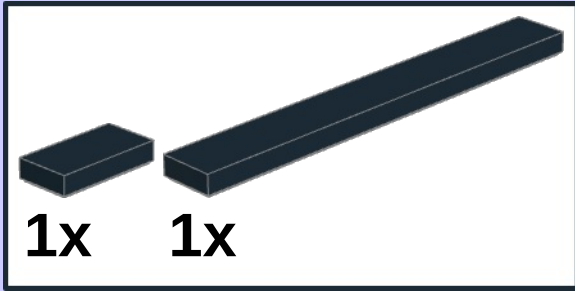

7

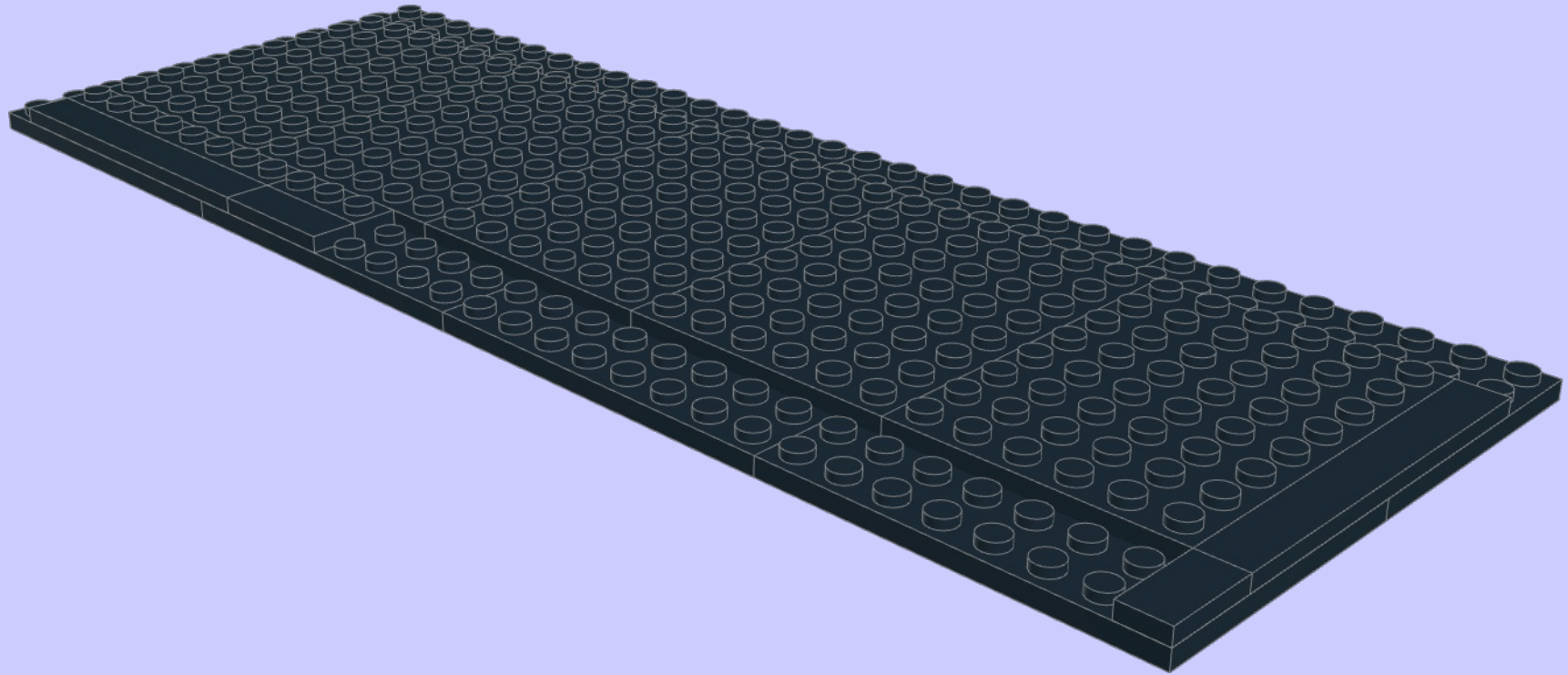
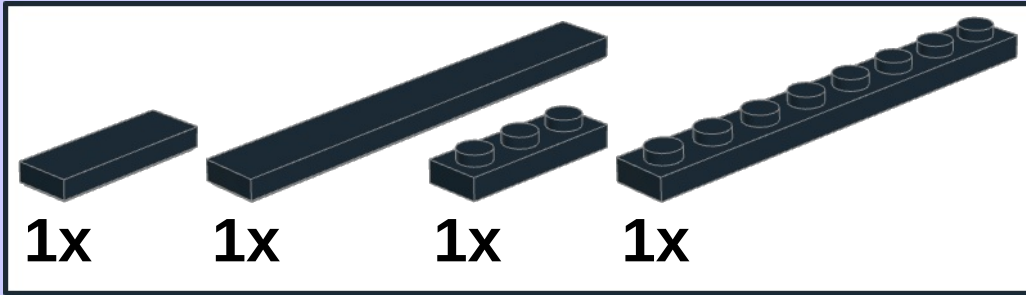

8

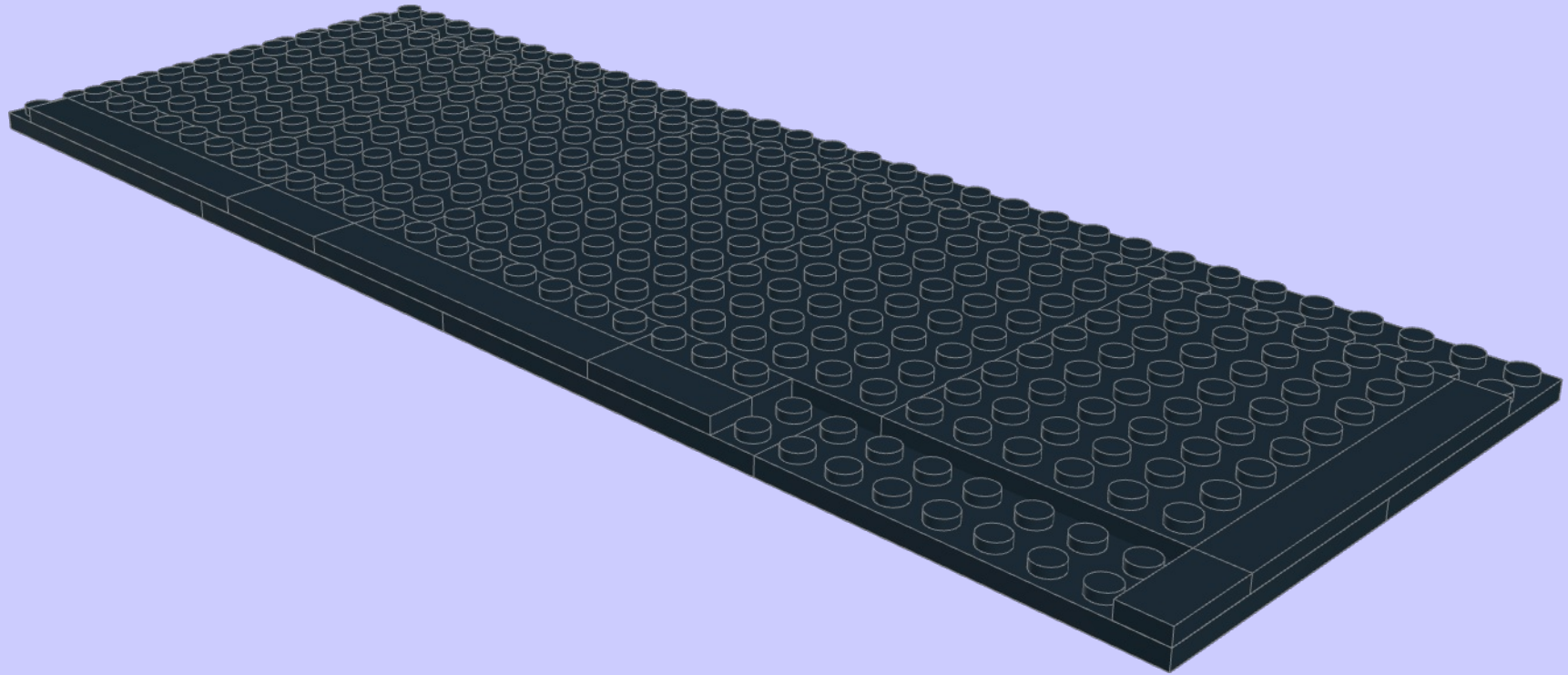
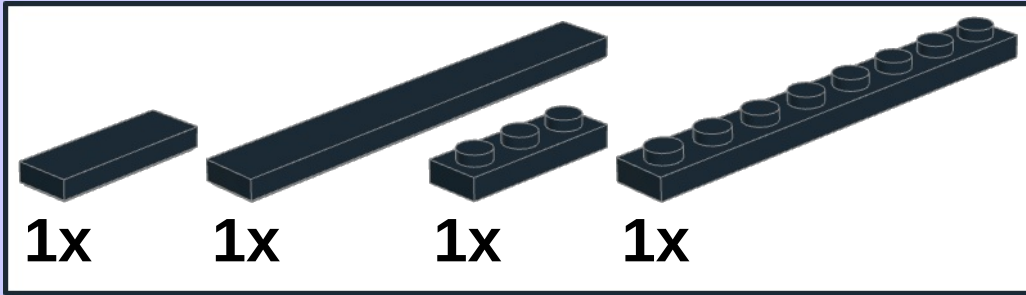

9

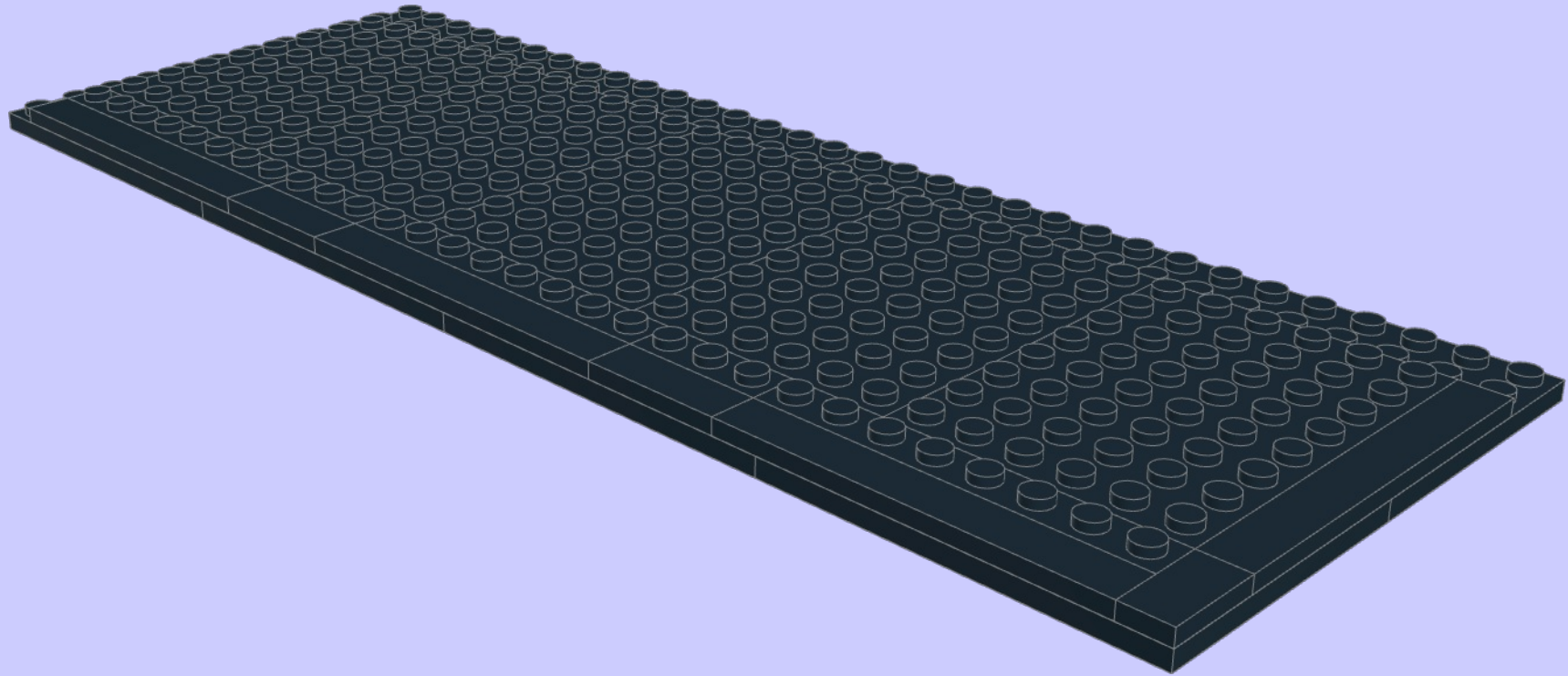
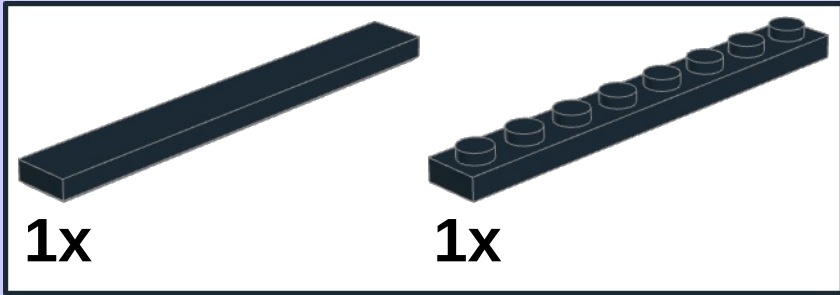

10

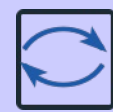
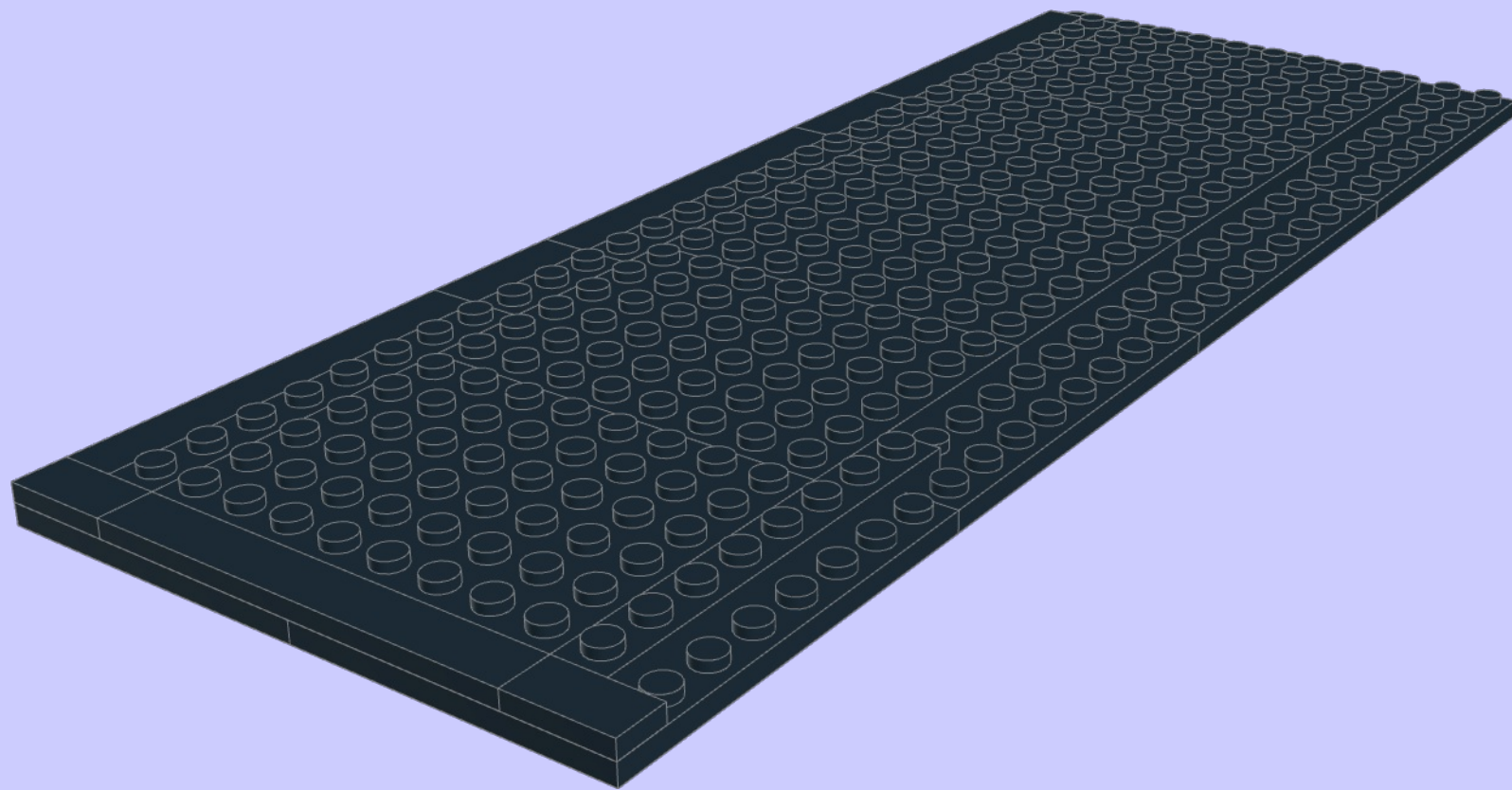
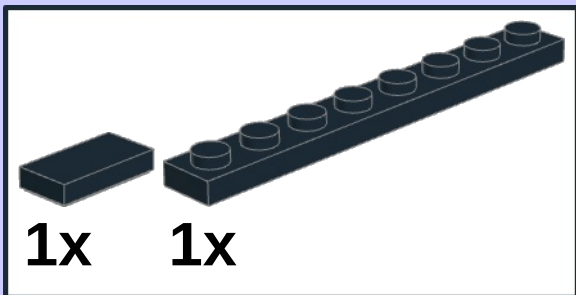

11

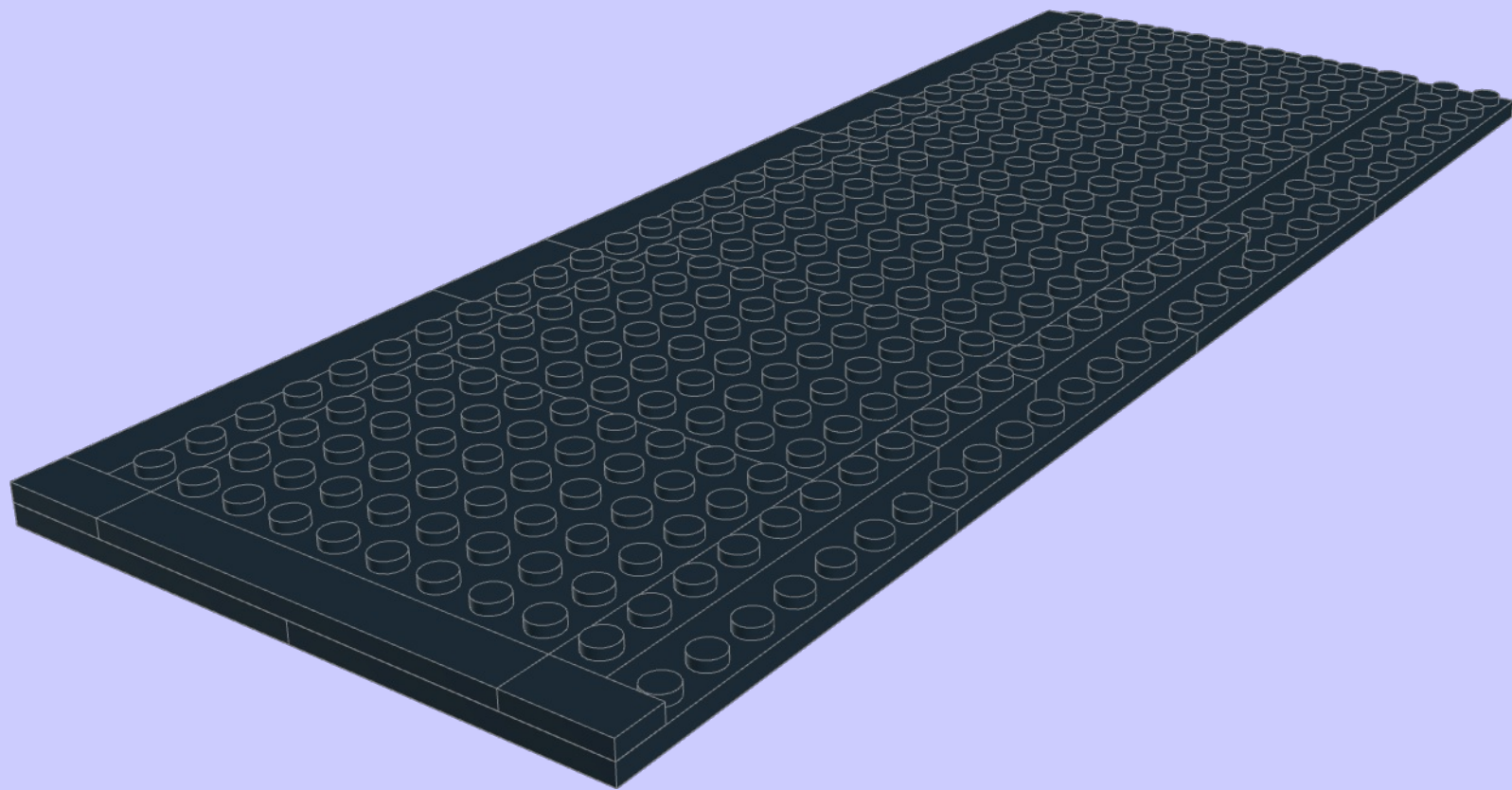
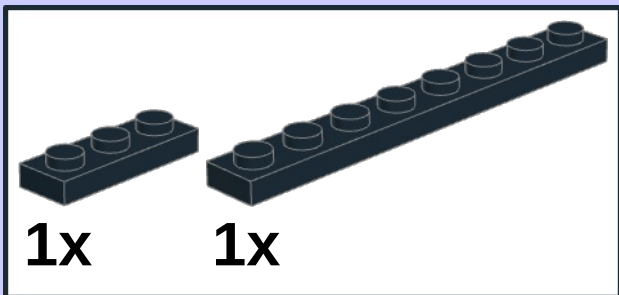

12

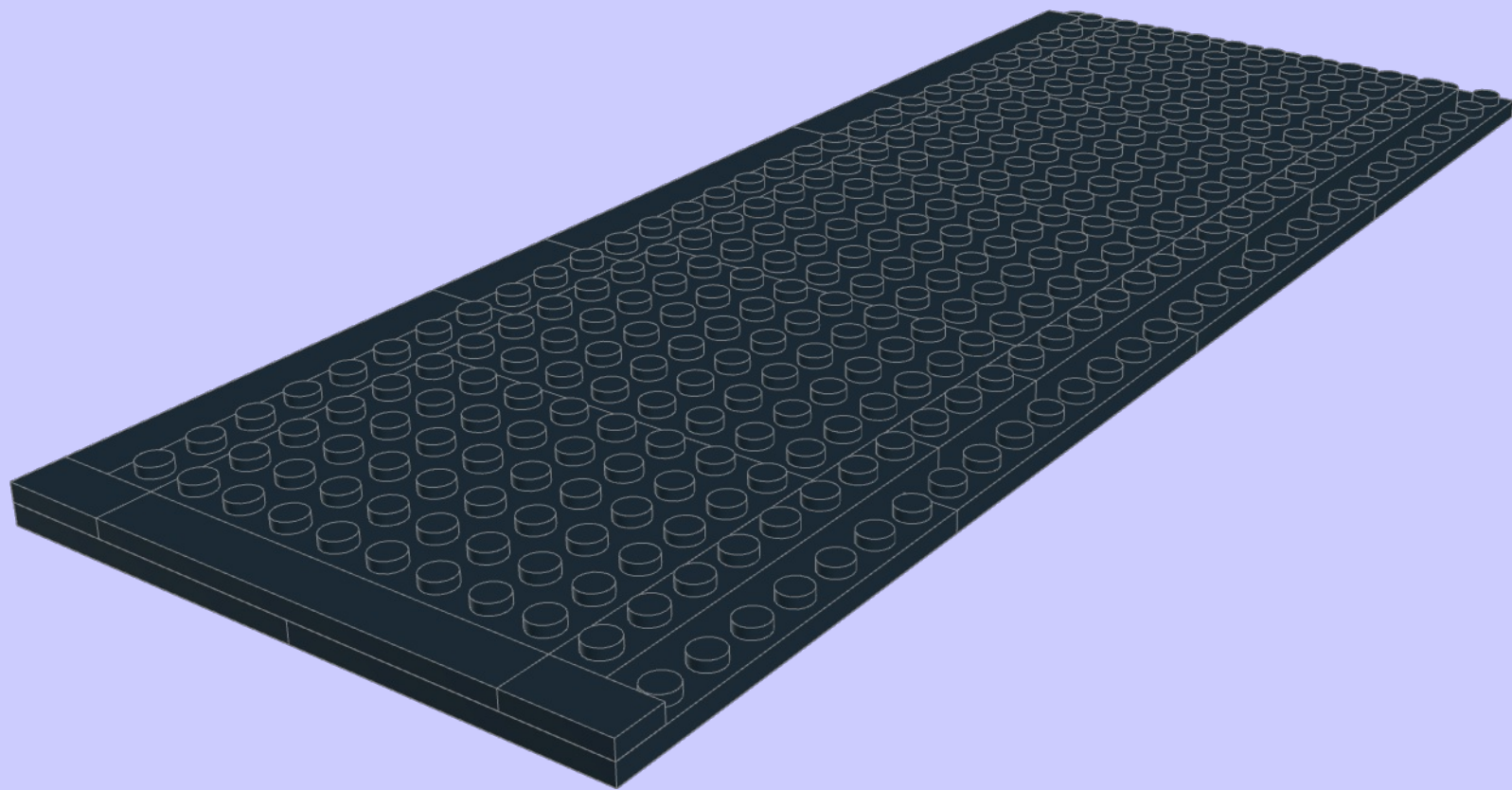
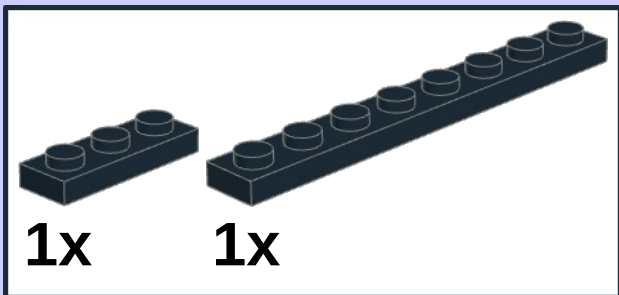

13

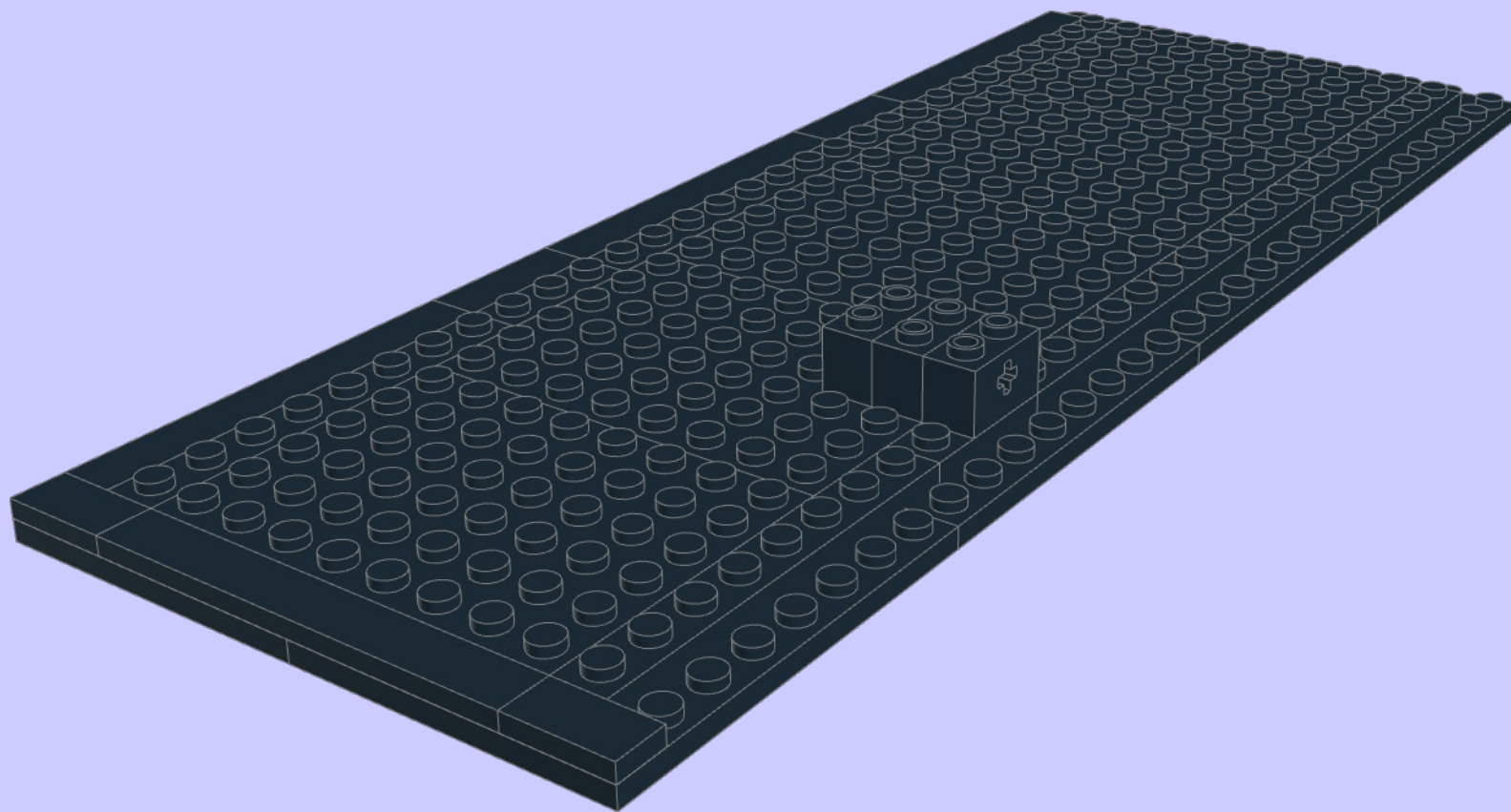

14

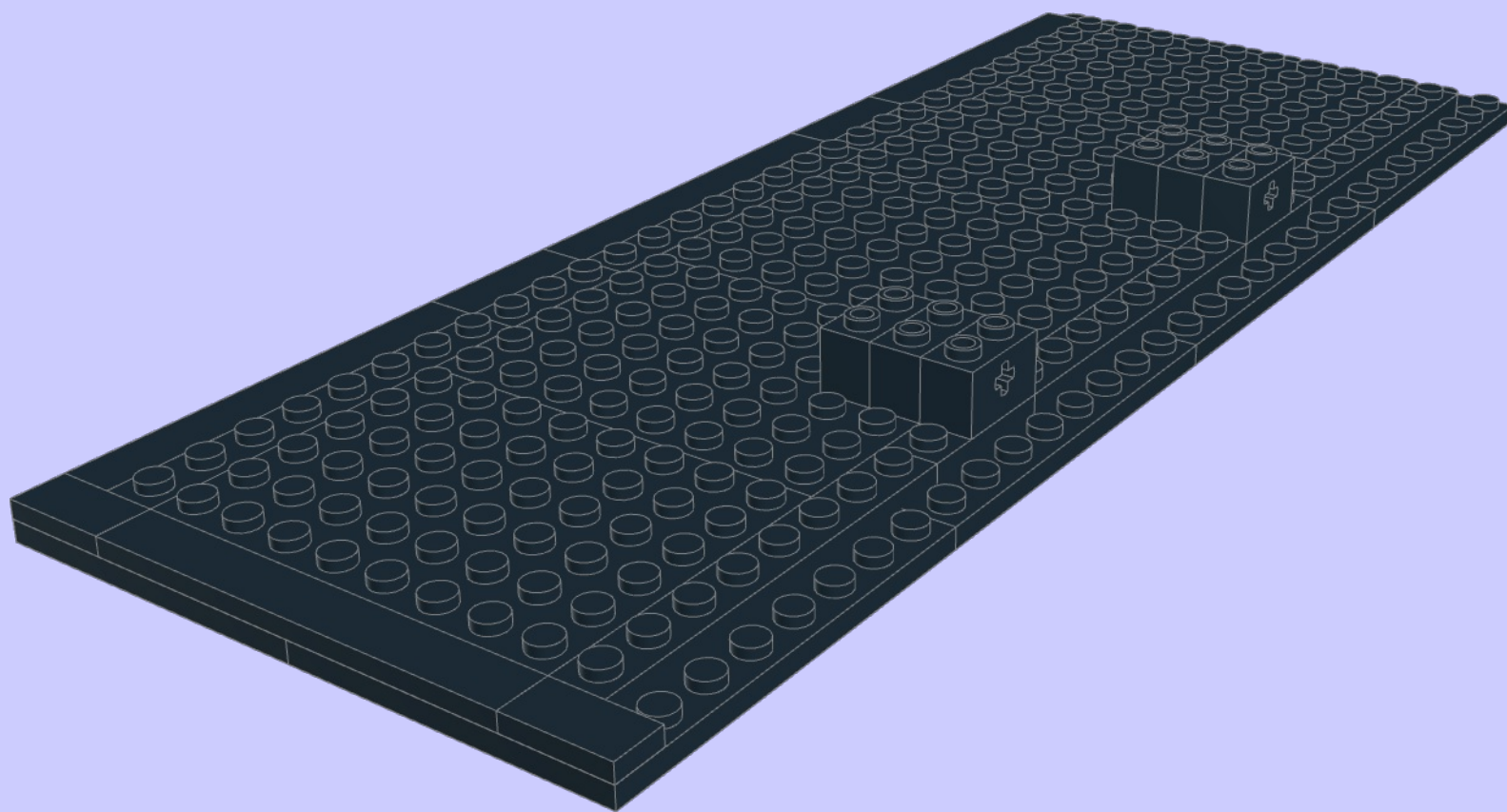

15

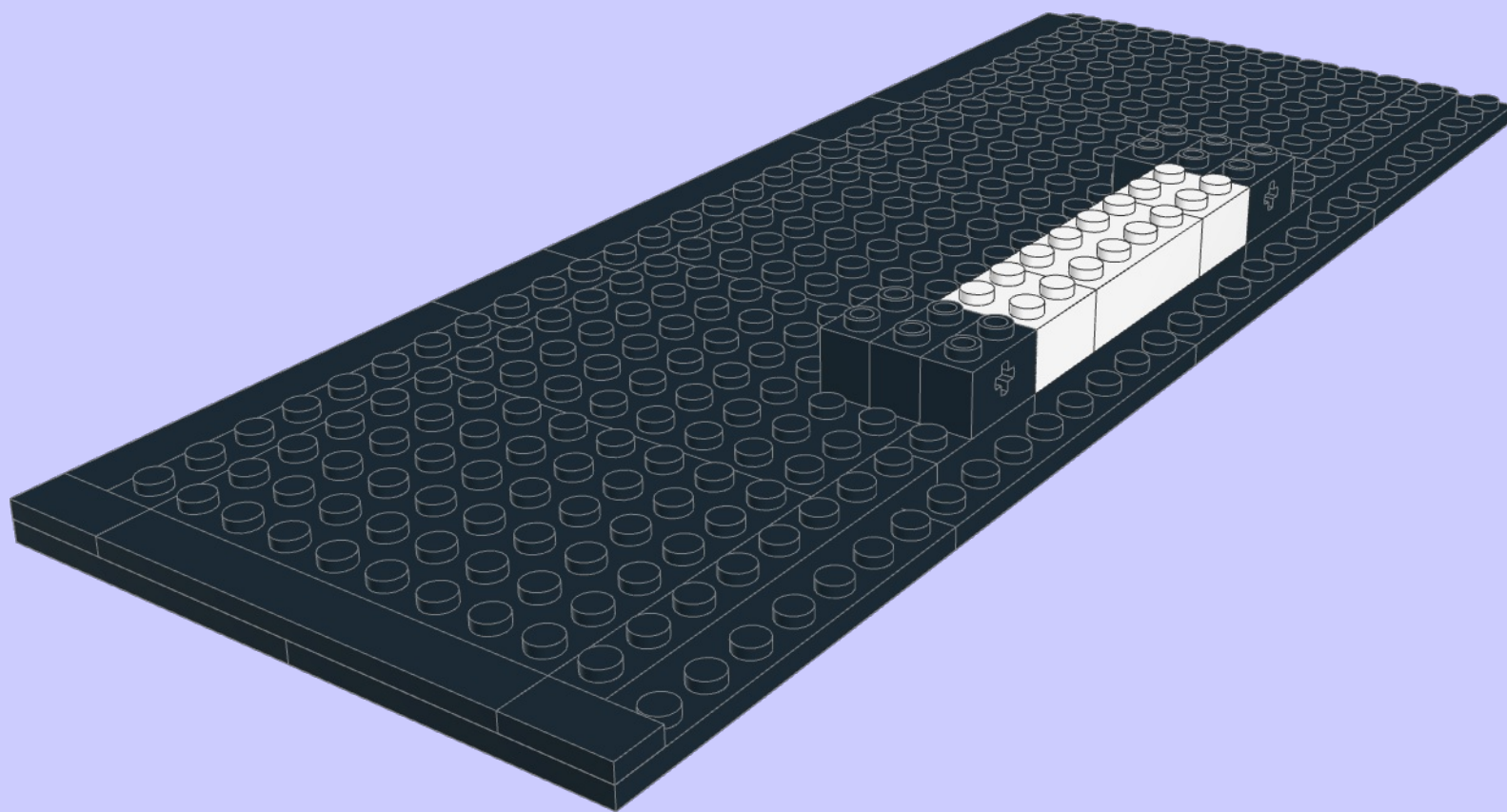
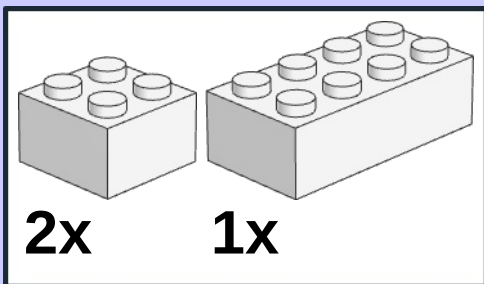

16

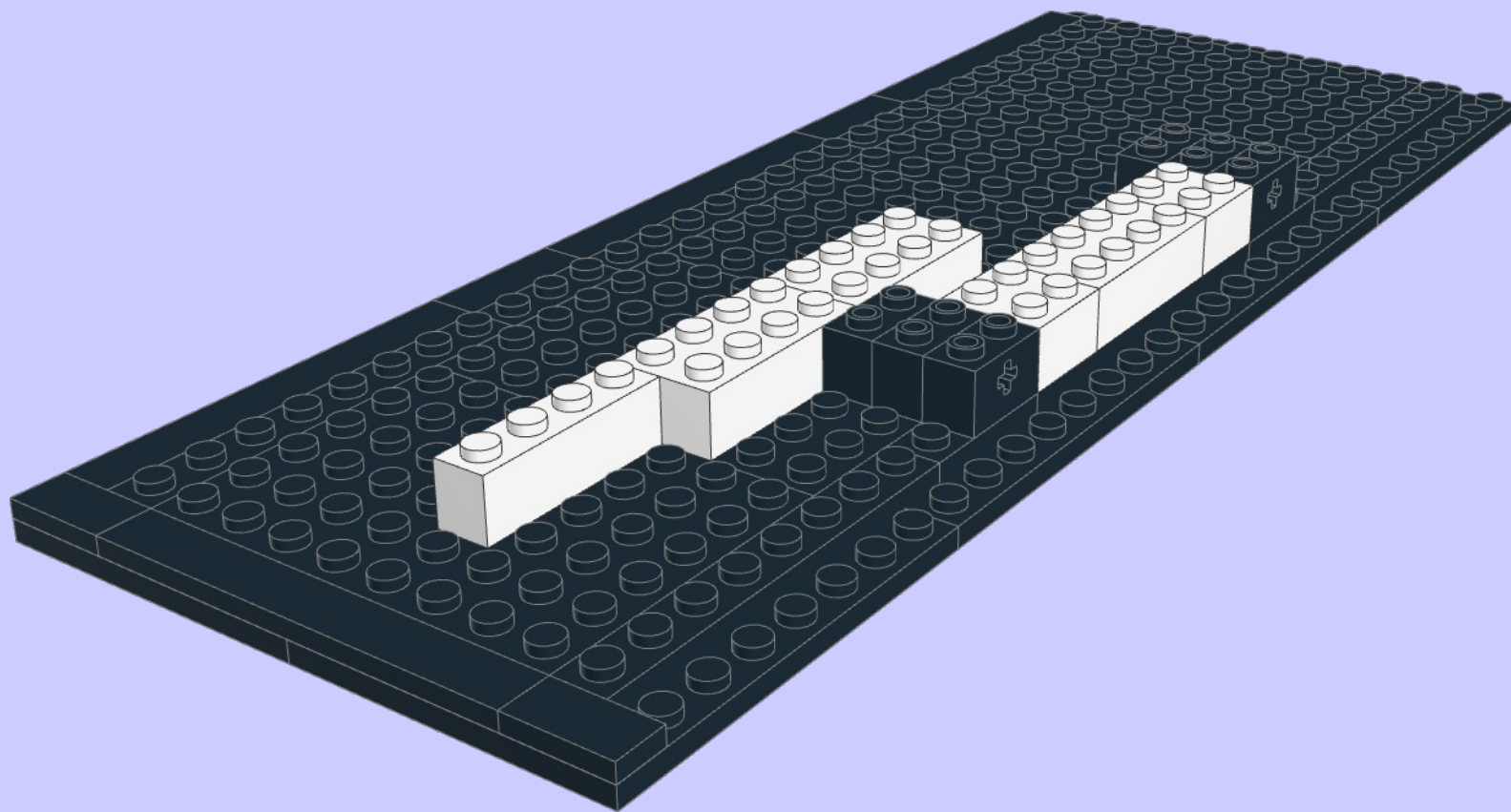
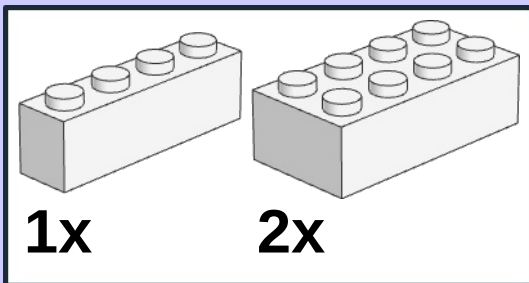

17

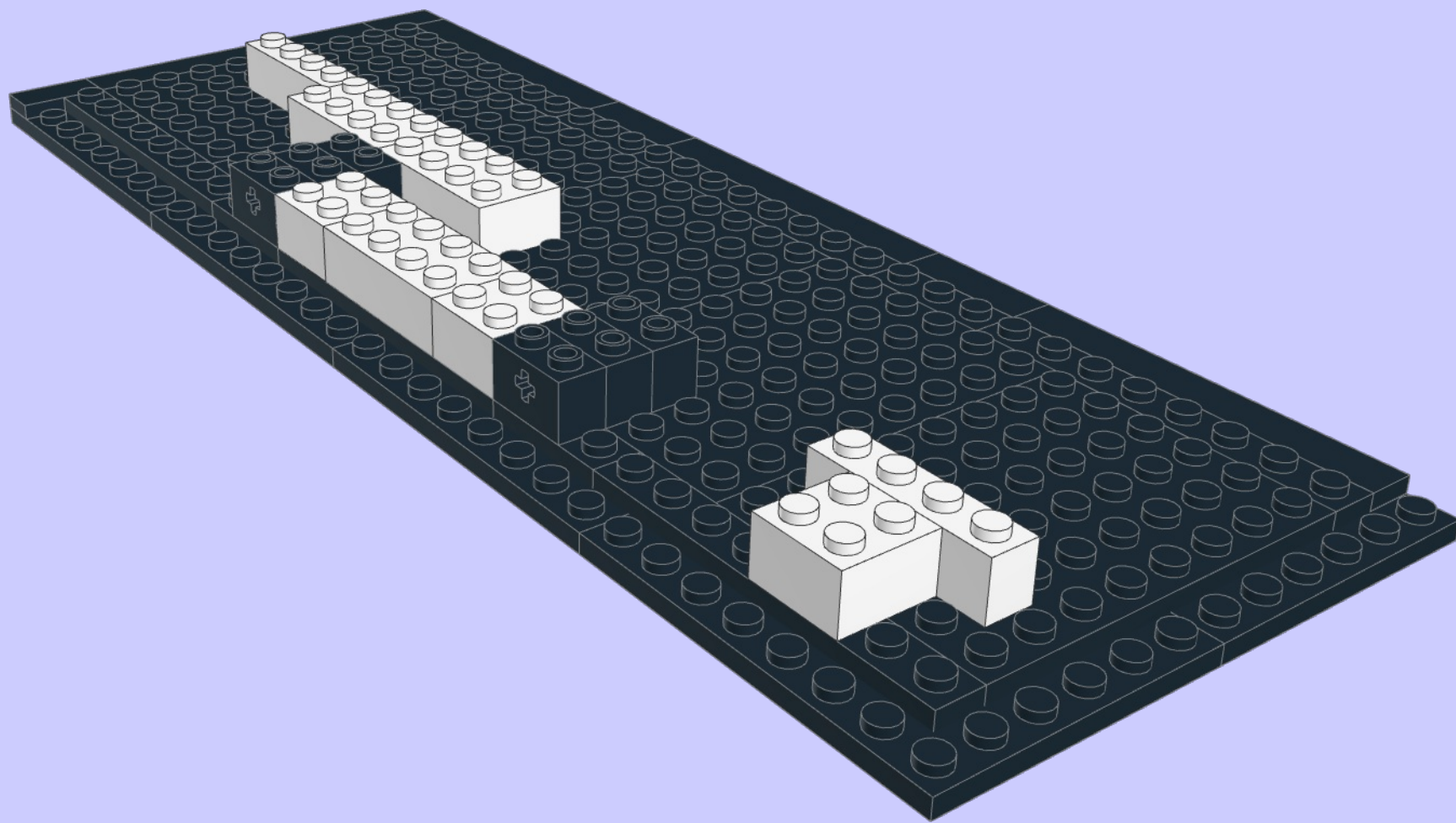
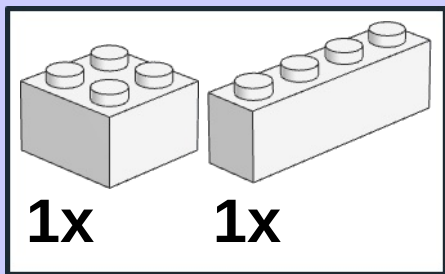

18

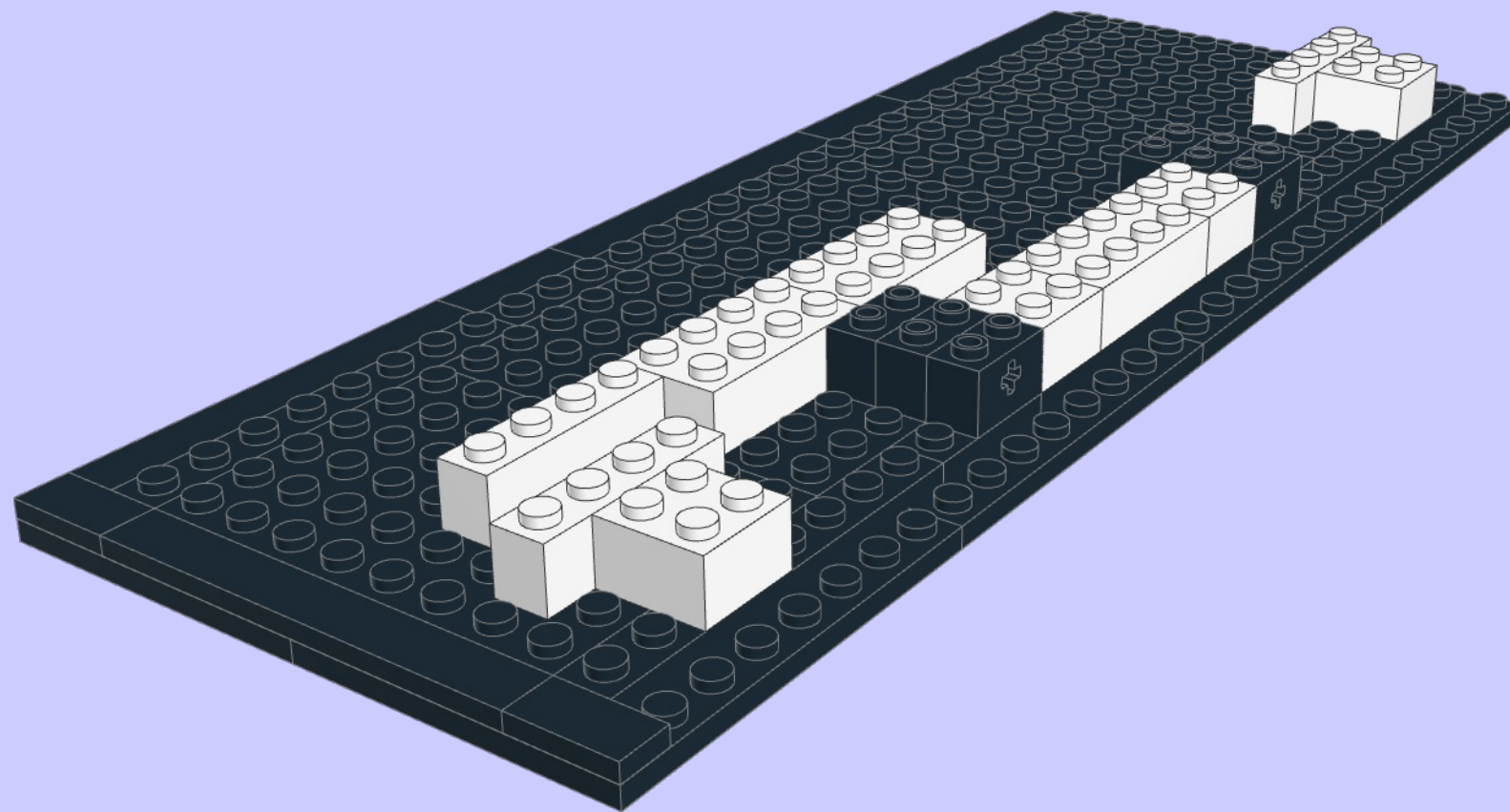
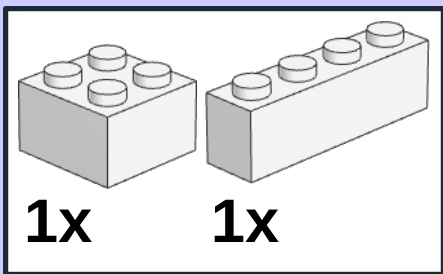

19

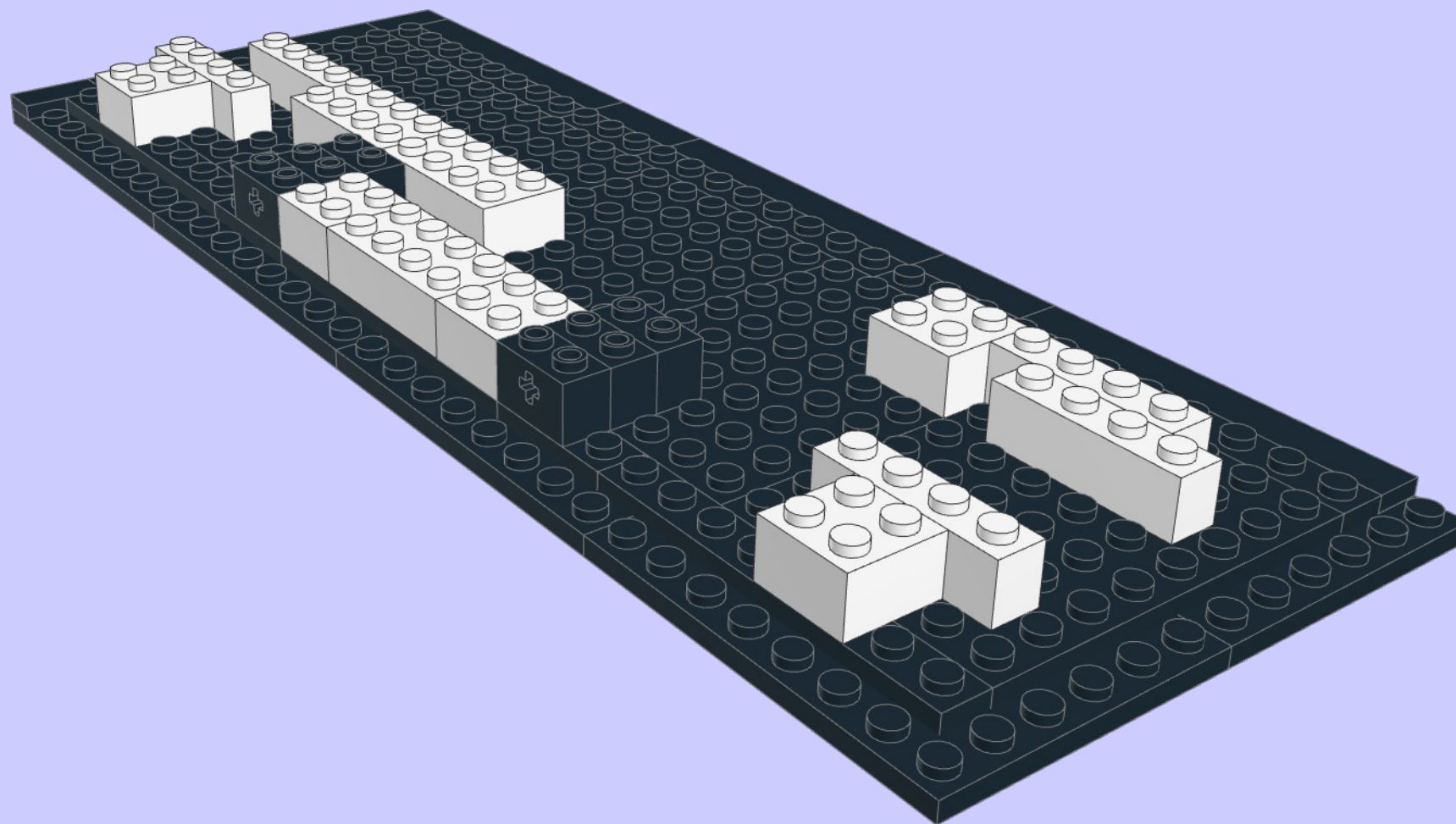
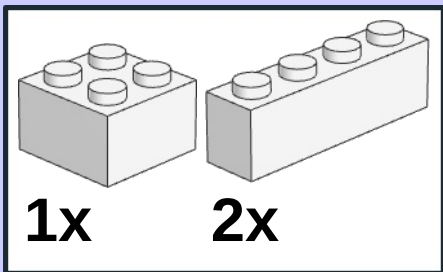

20

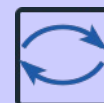
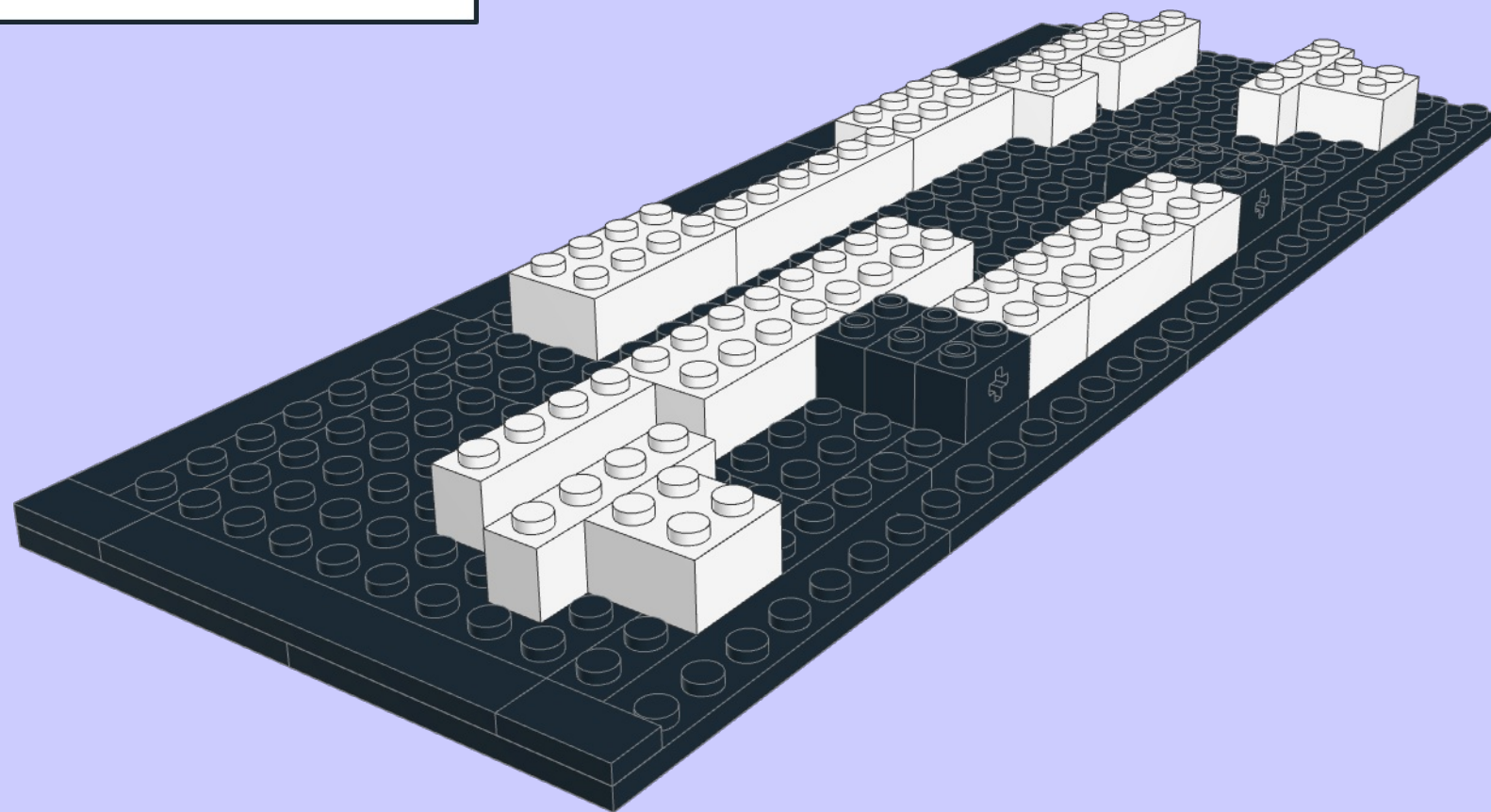
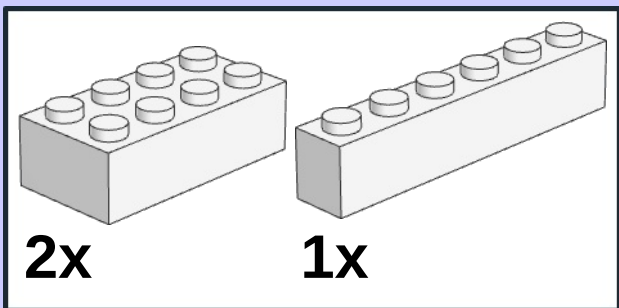

21

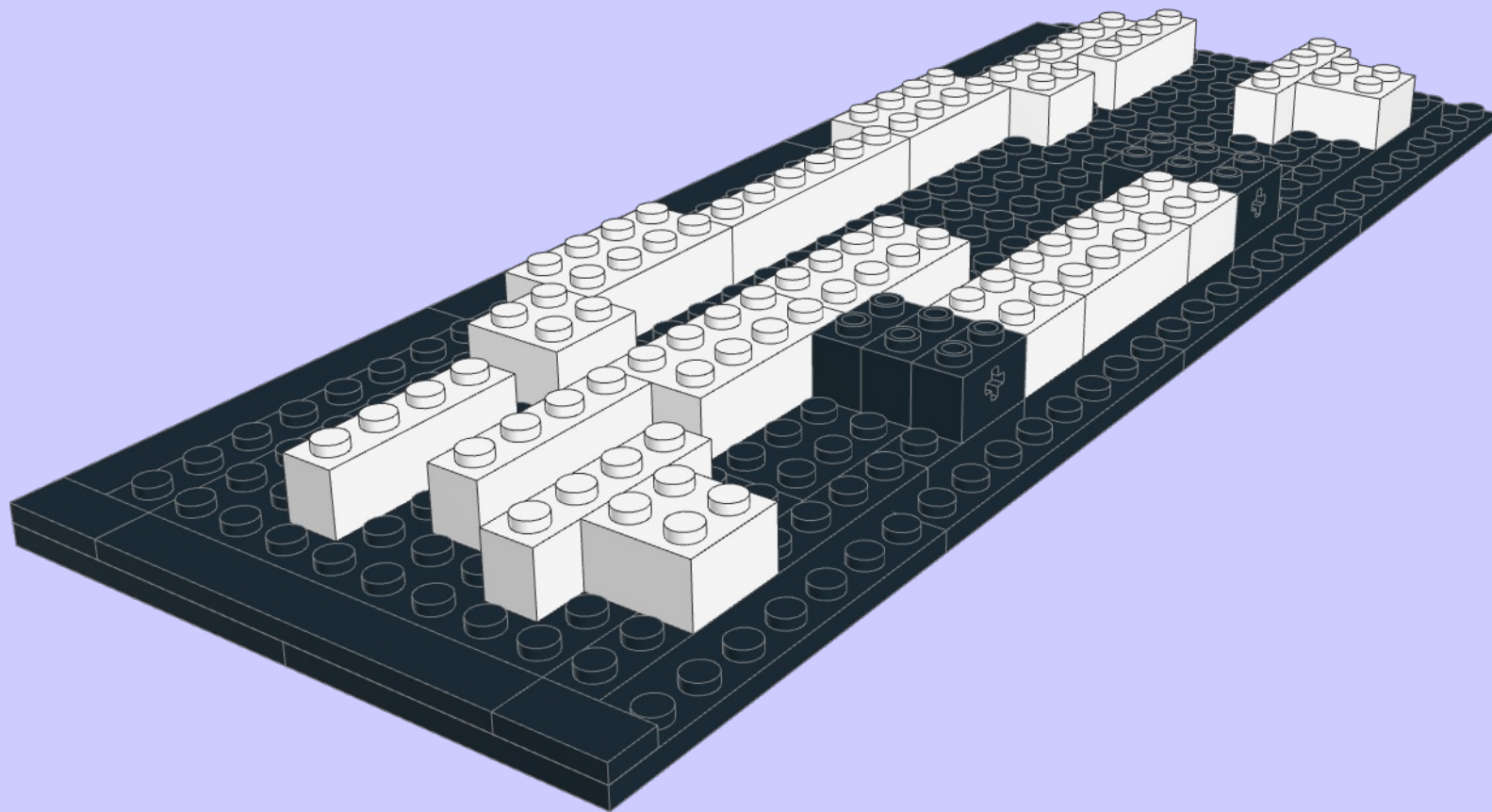
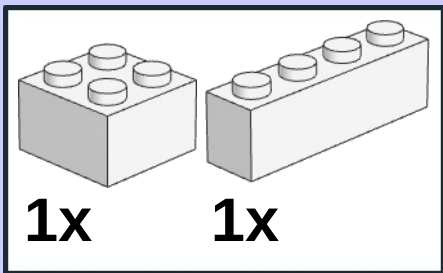

22

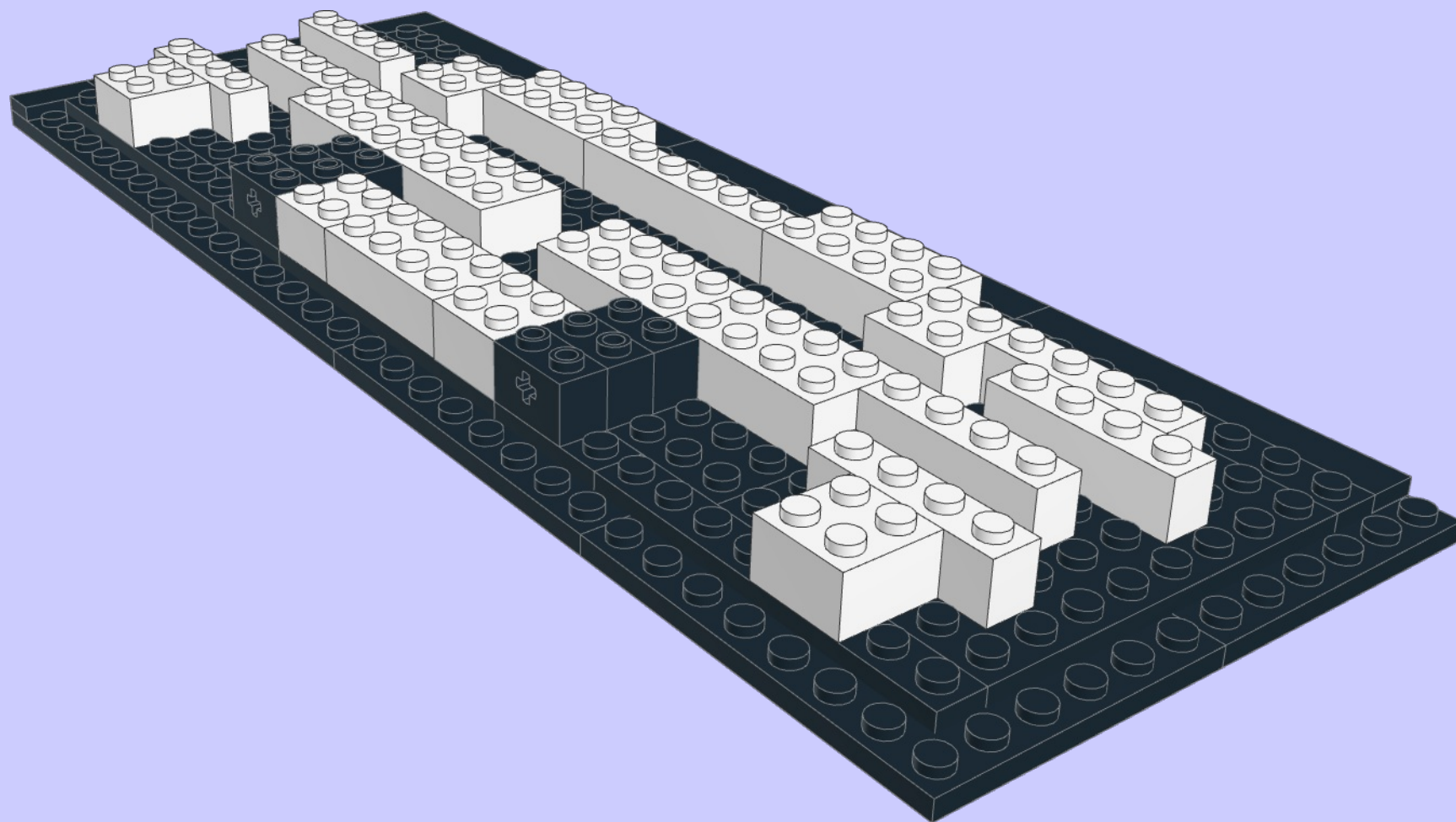
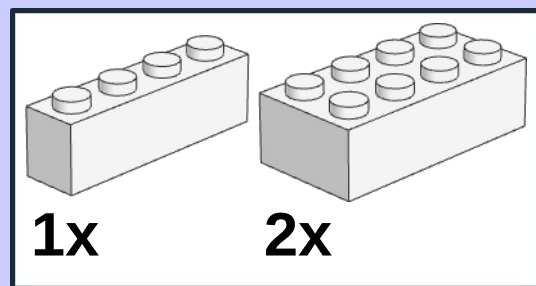

23

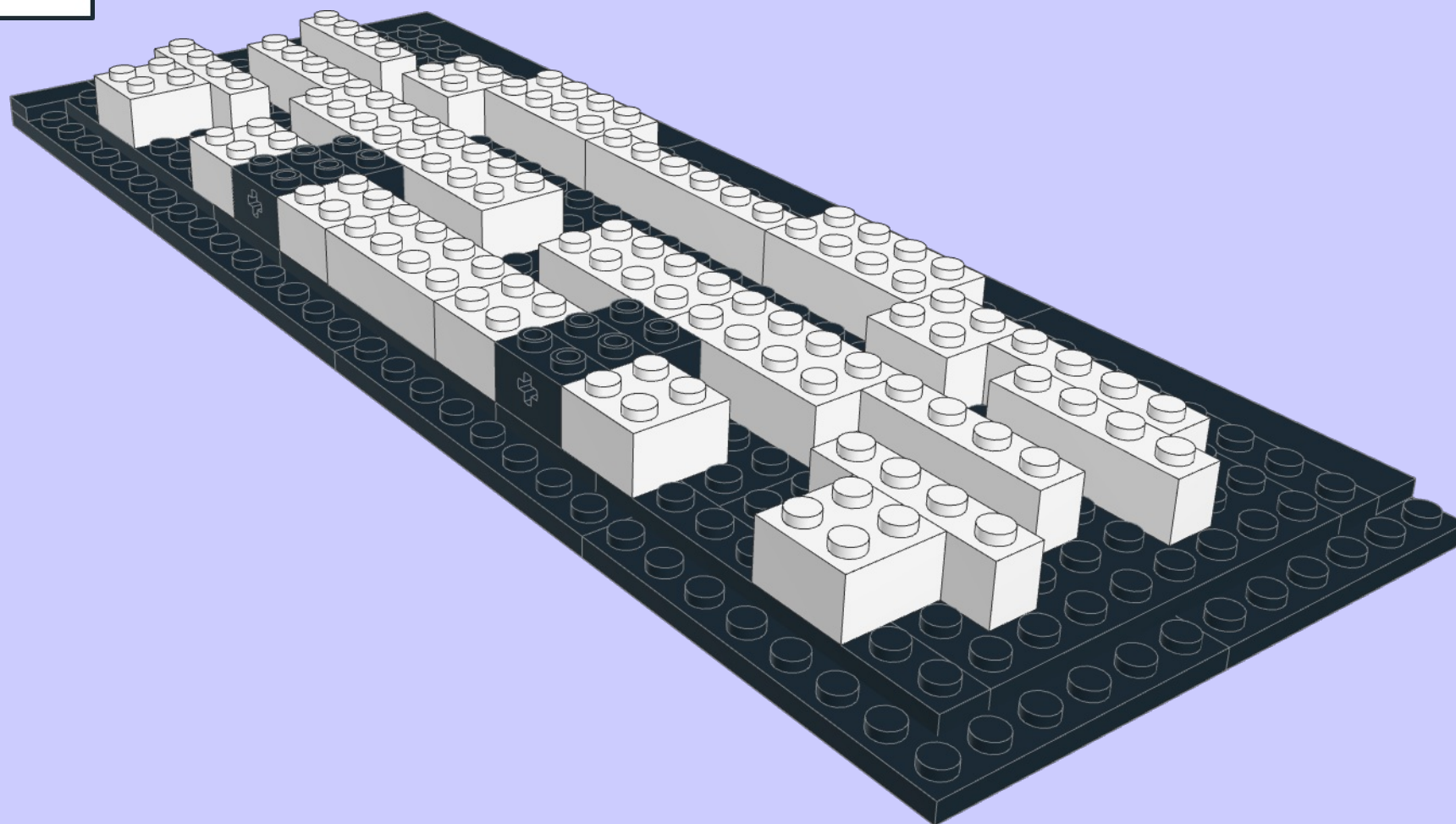
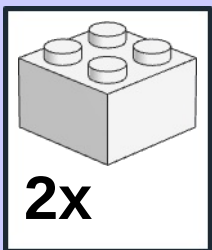

24

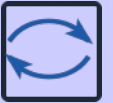
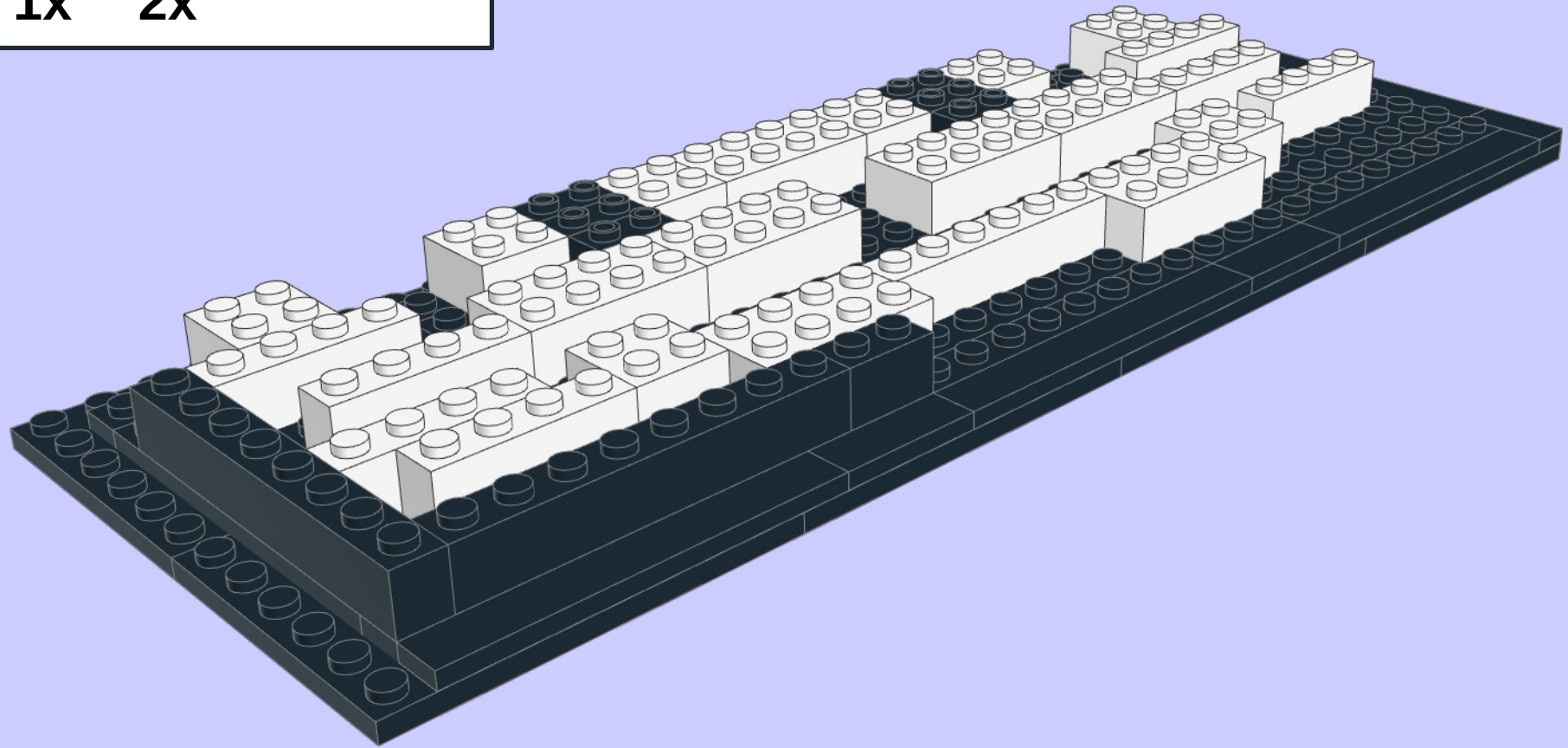
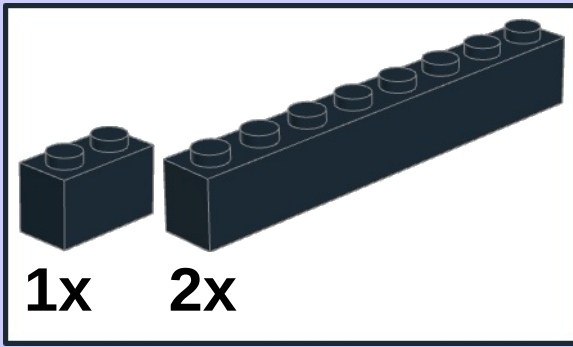

25

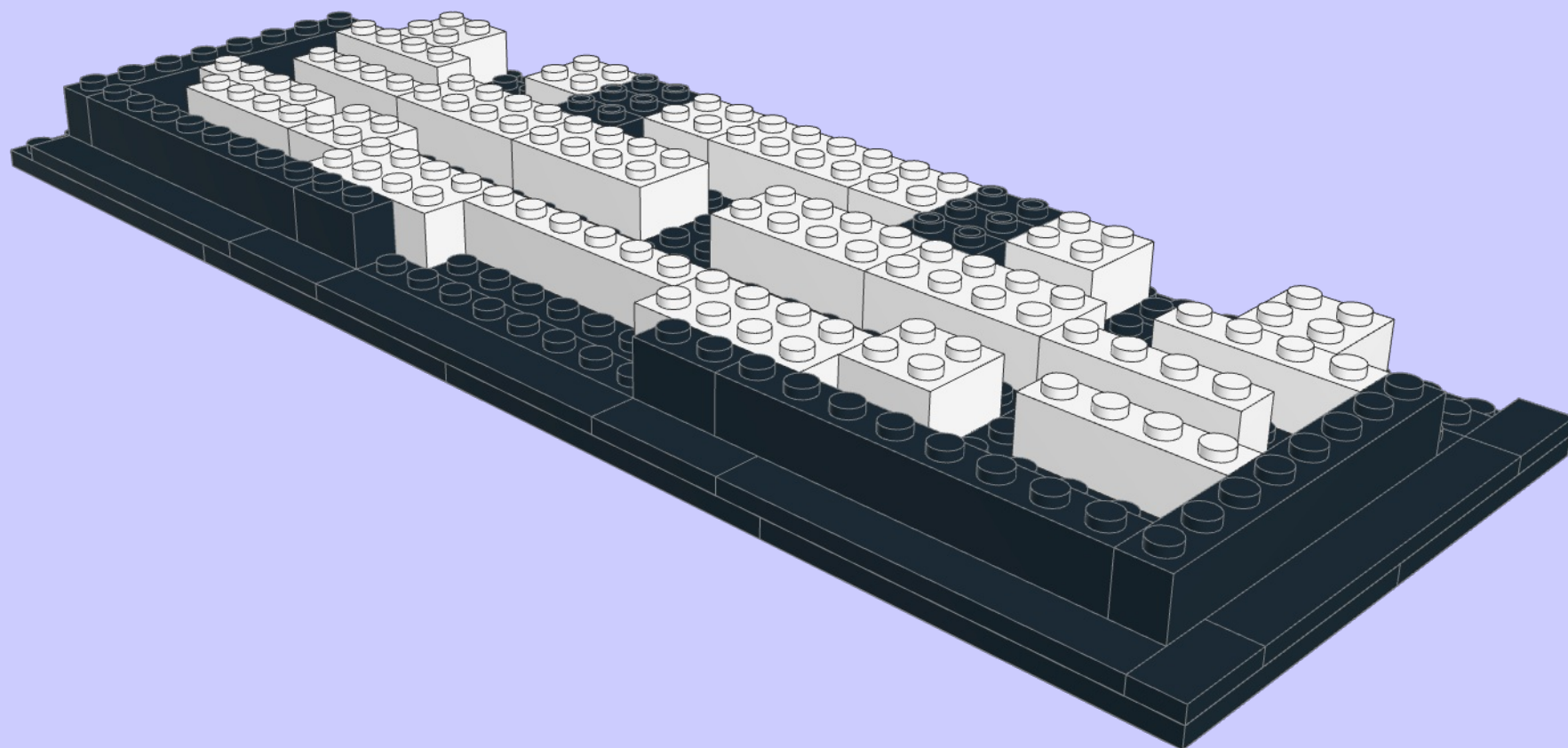
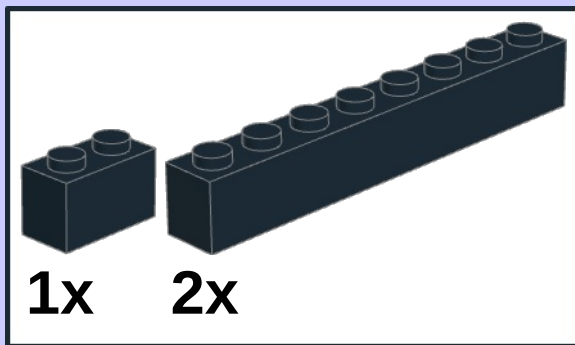

26

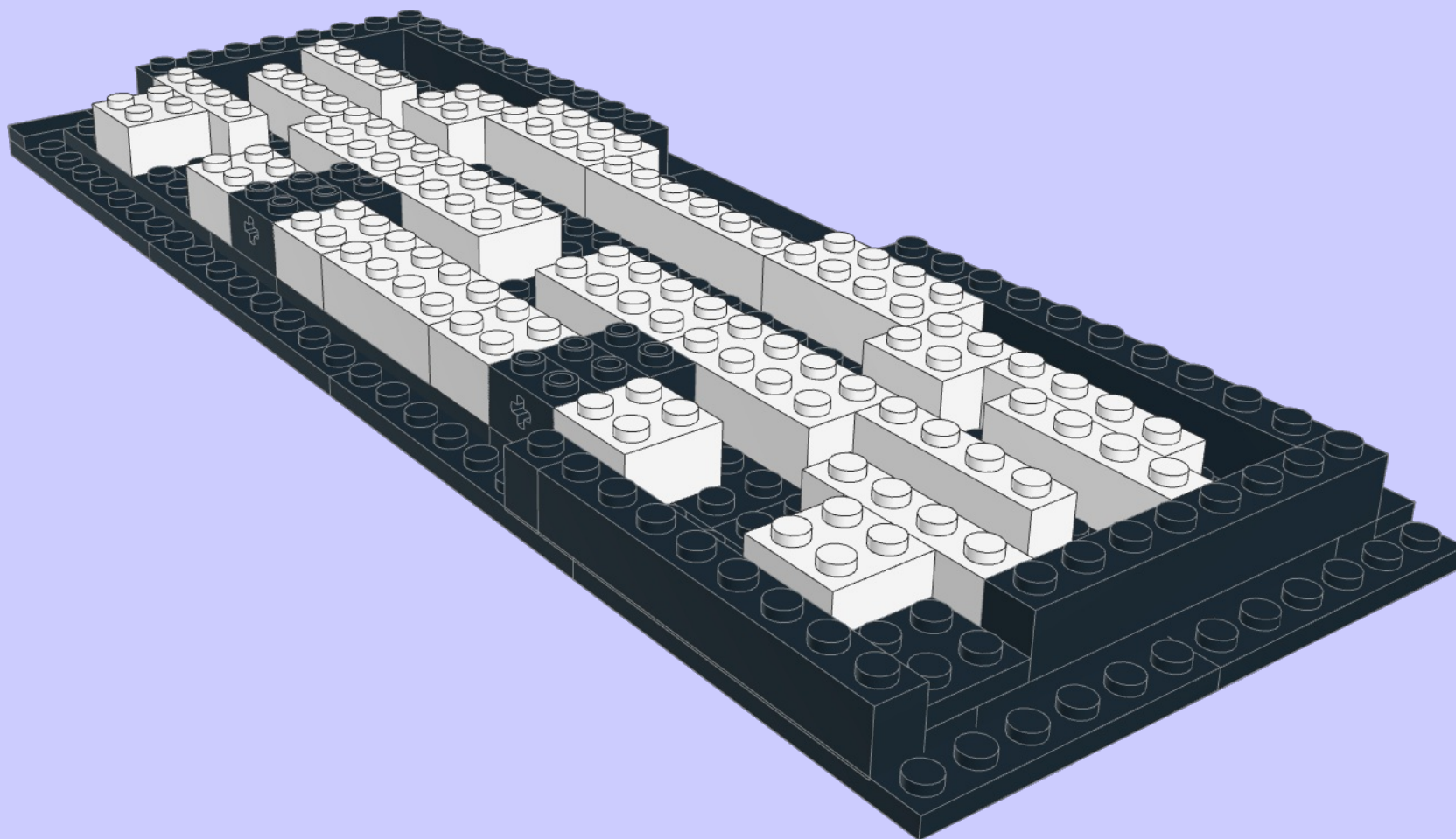
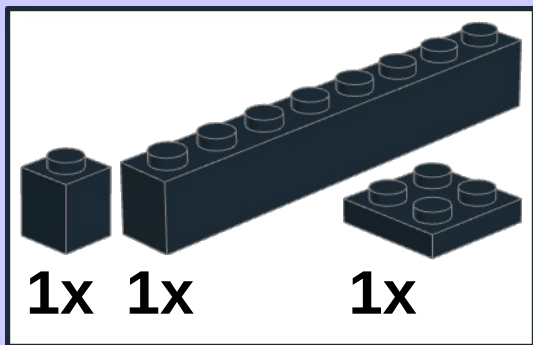

27

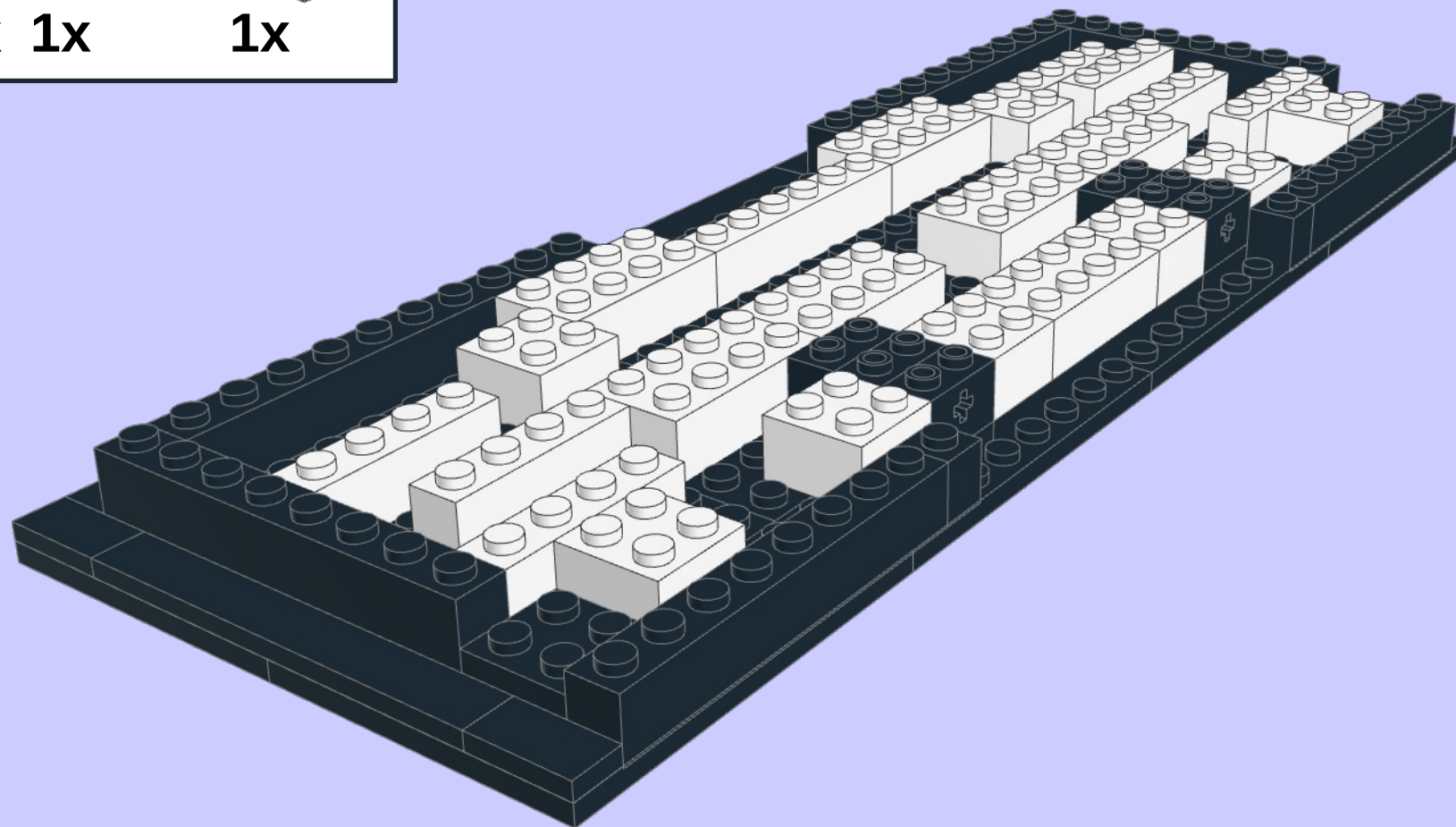
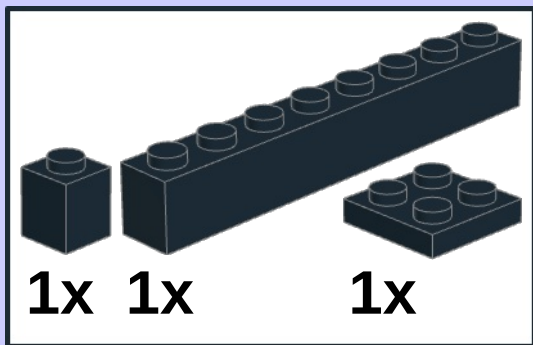

28

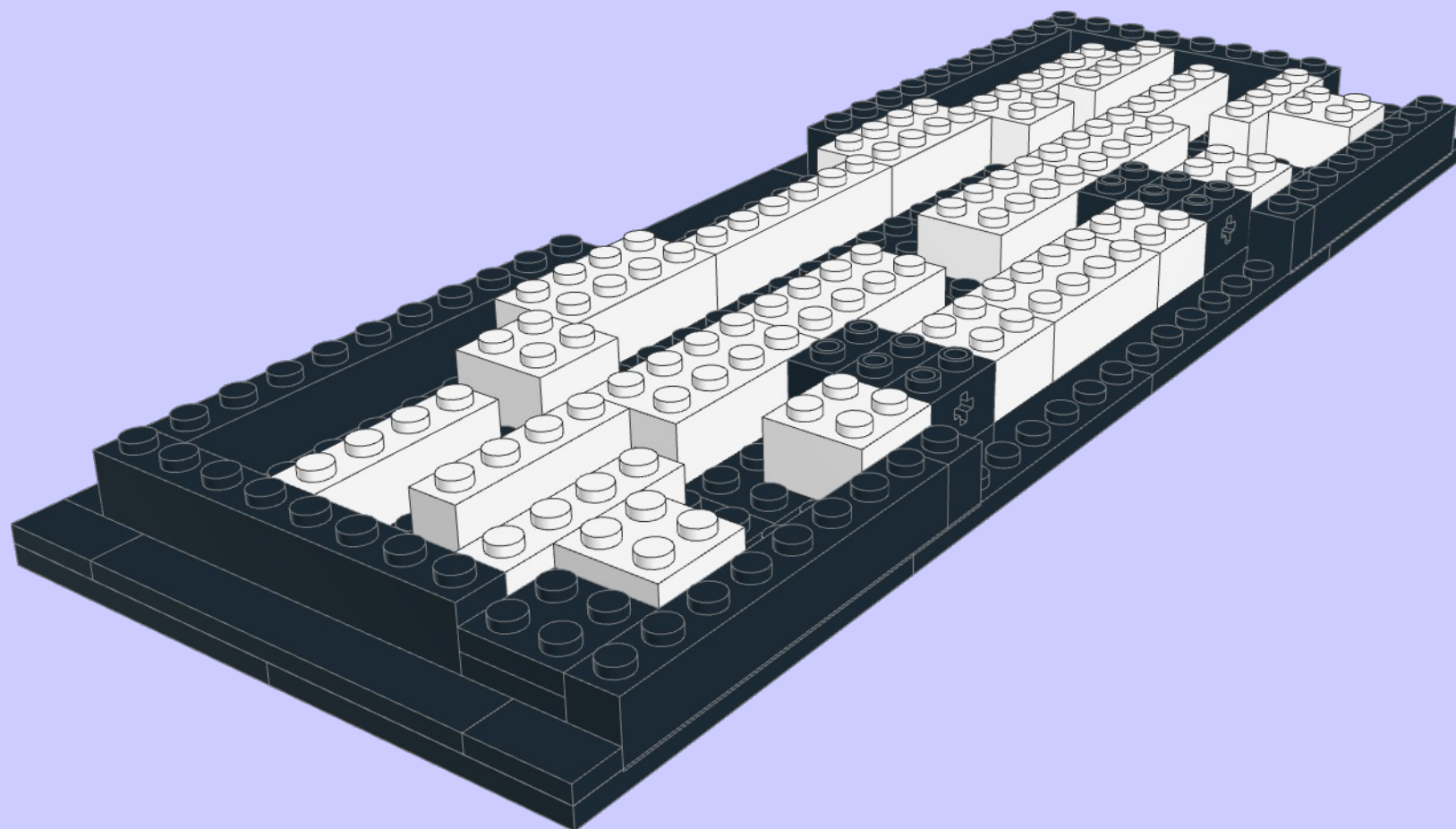
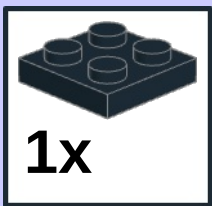

29

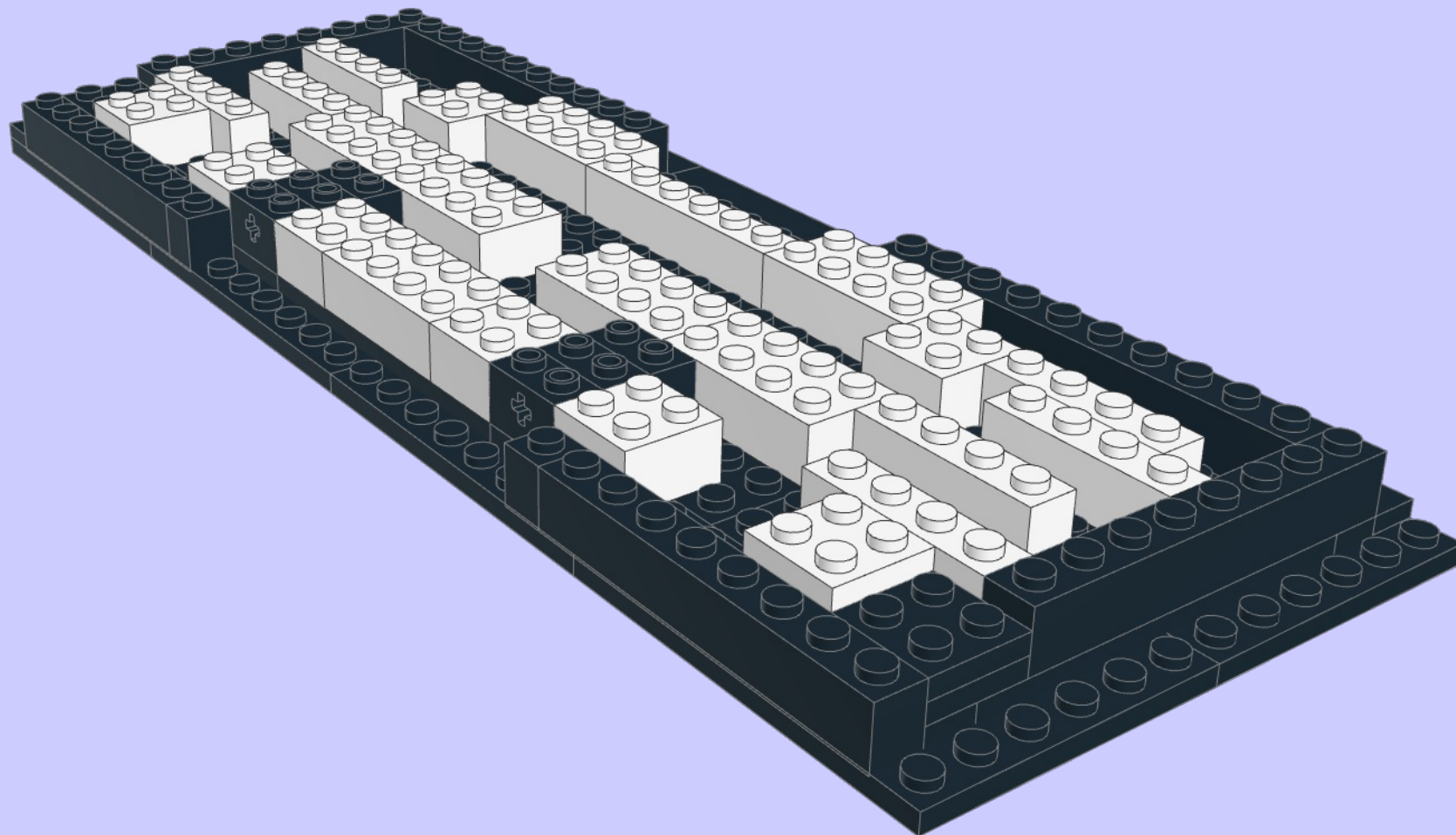
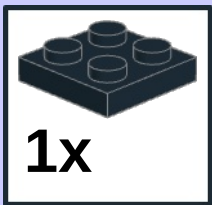

30

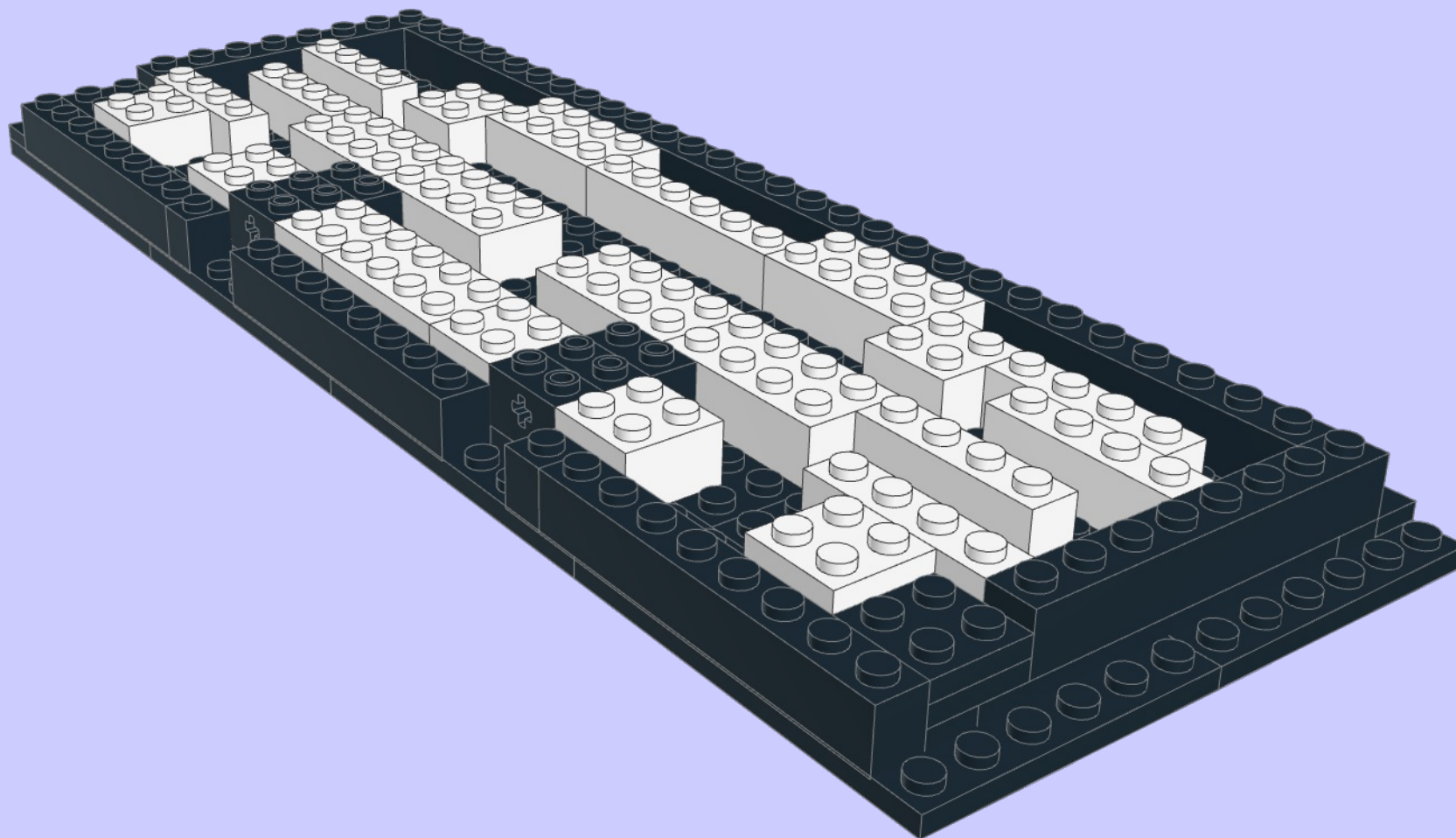
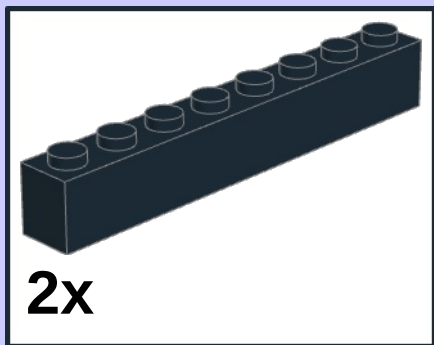

31

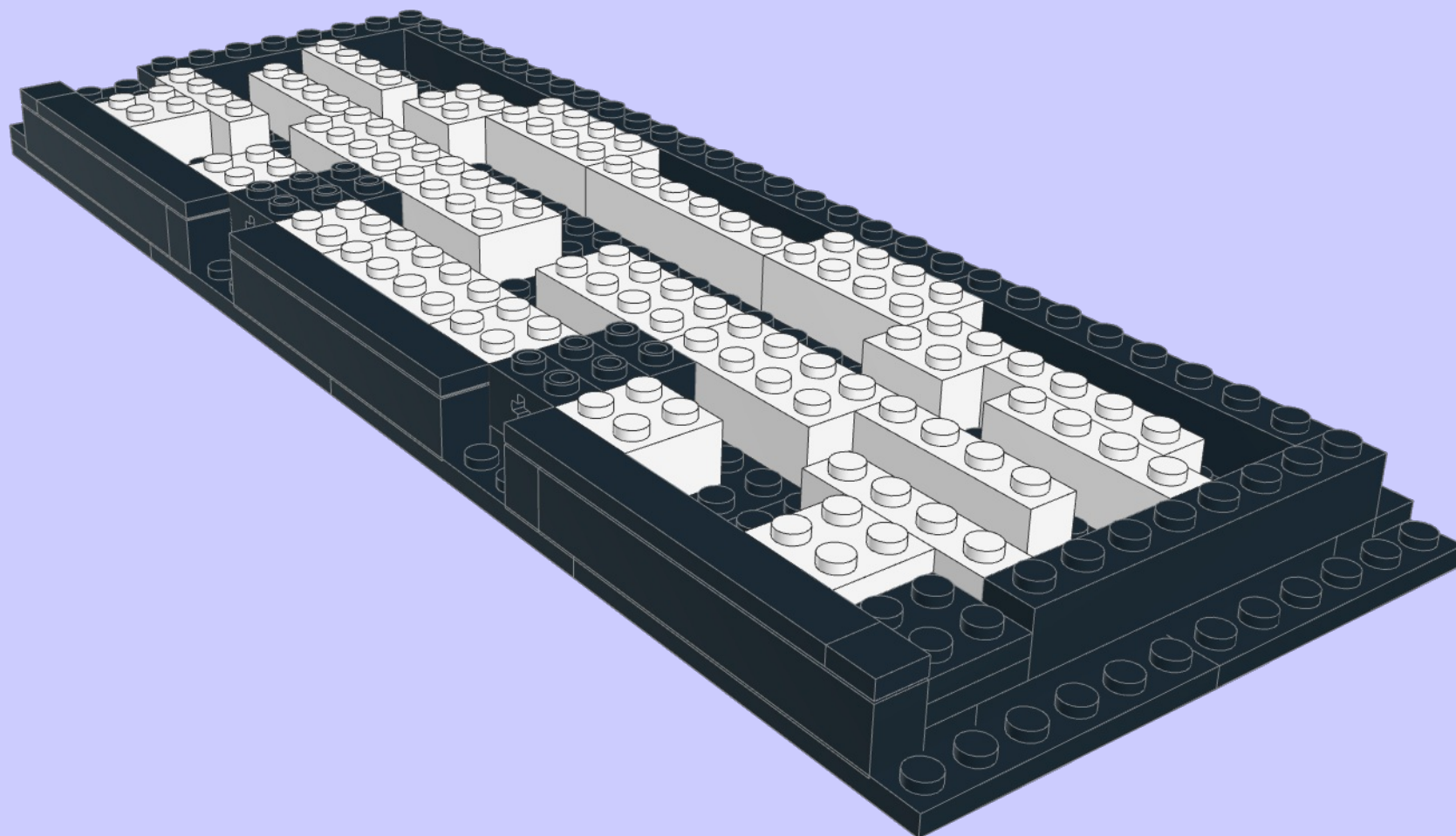
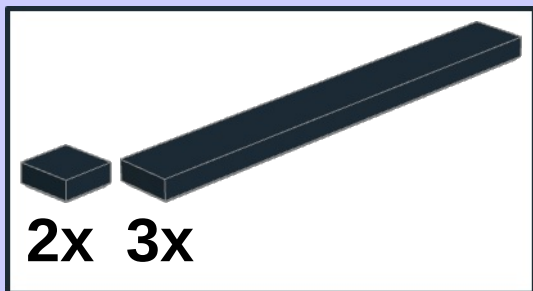

32

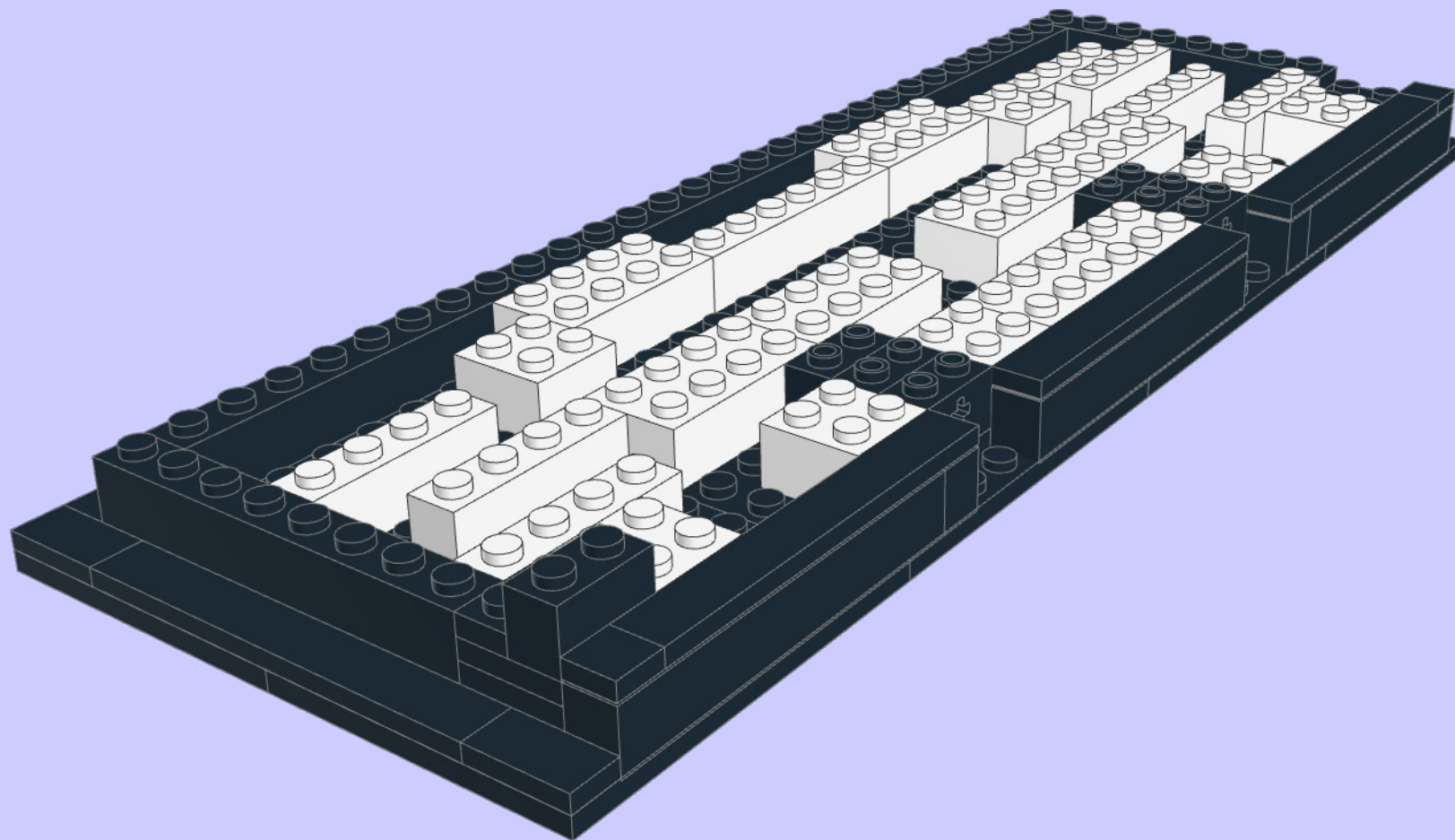
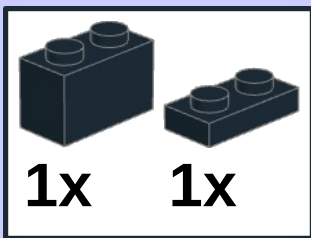

33

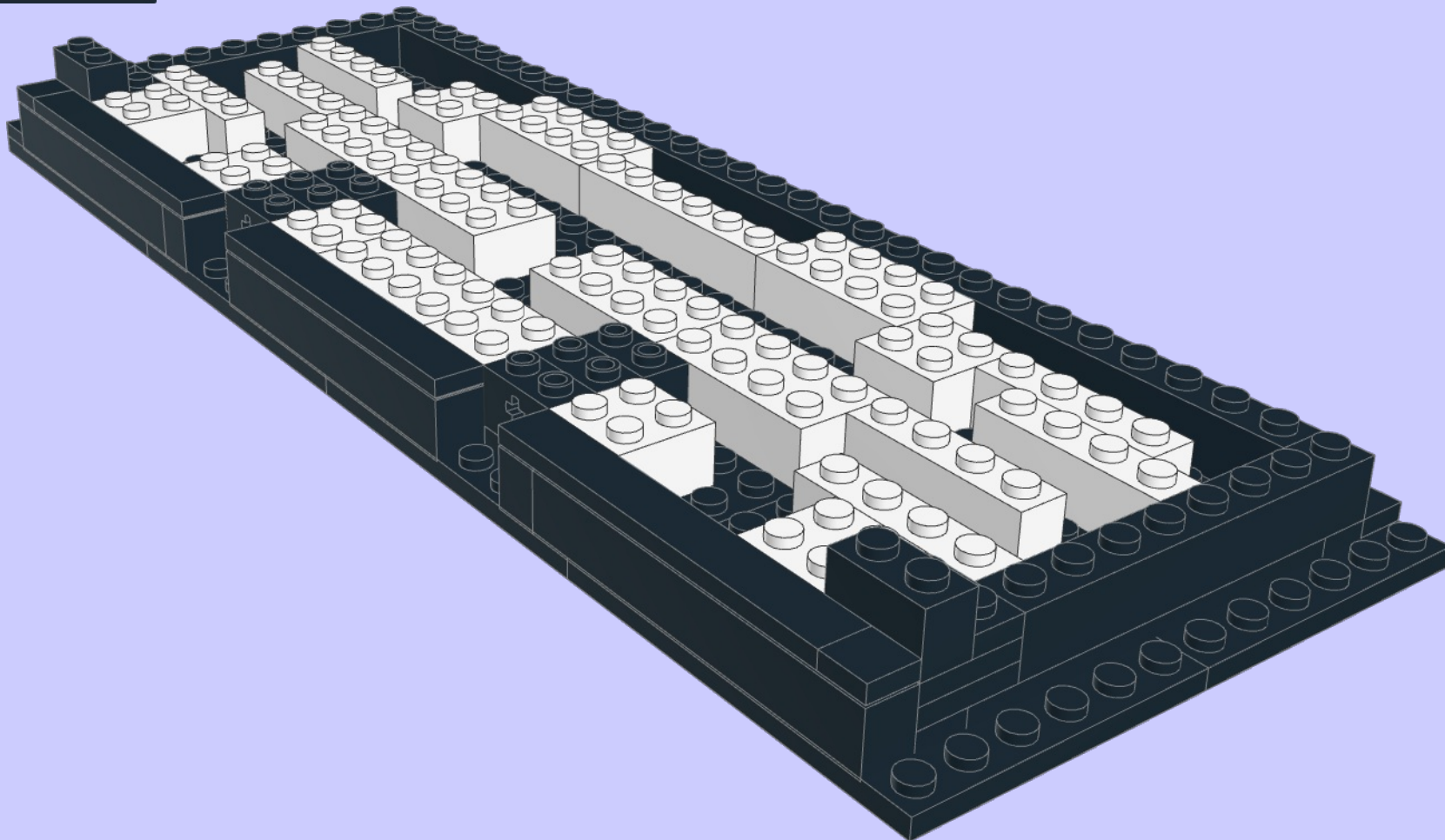
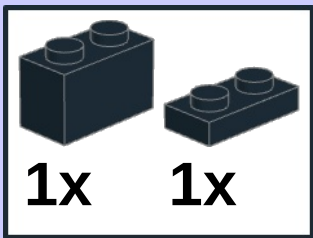

34

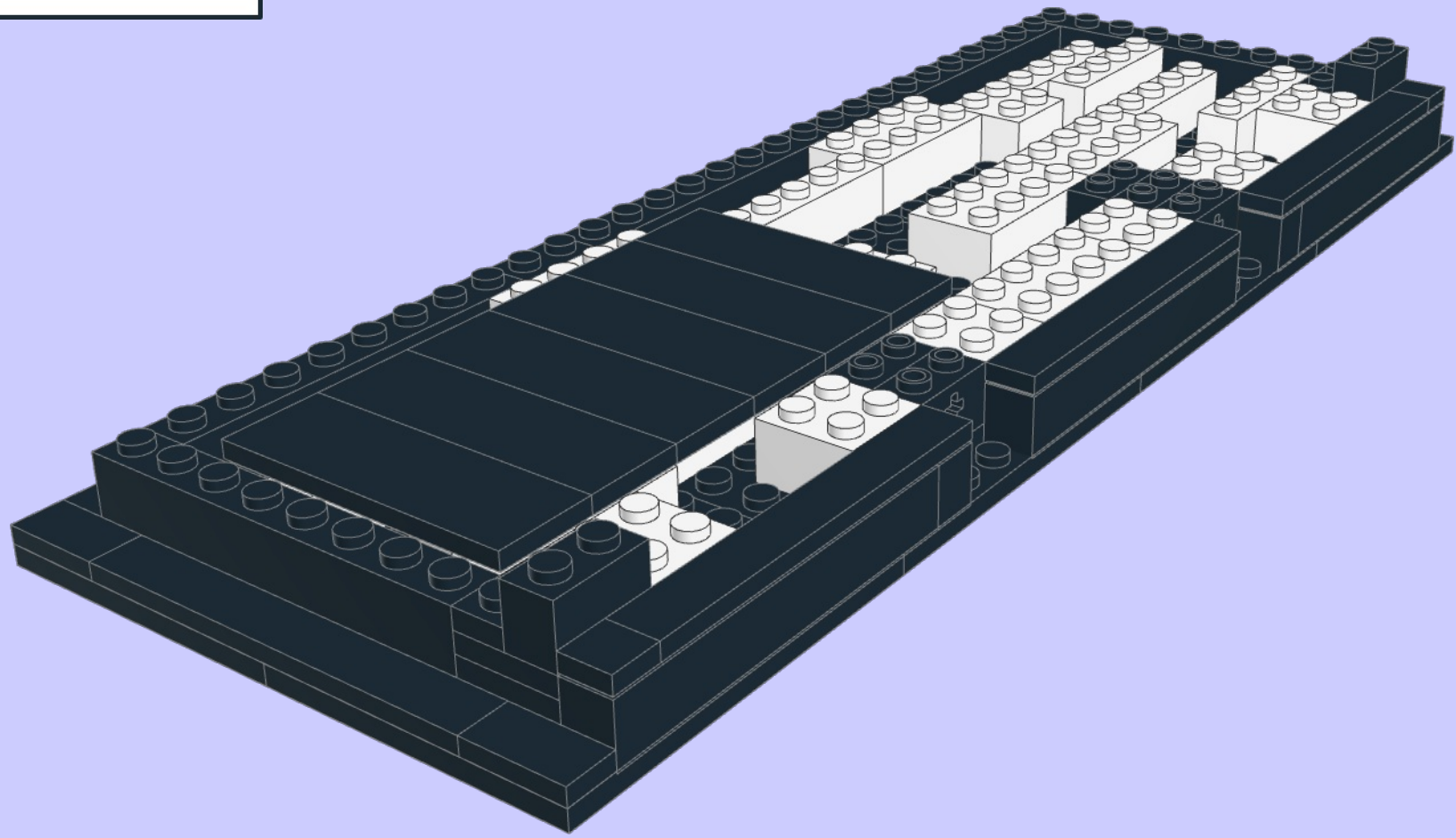
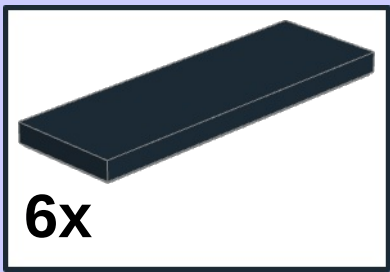

35

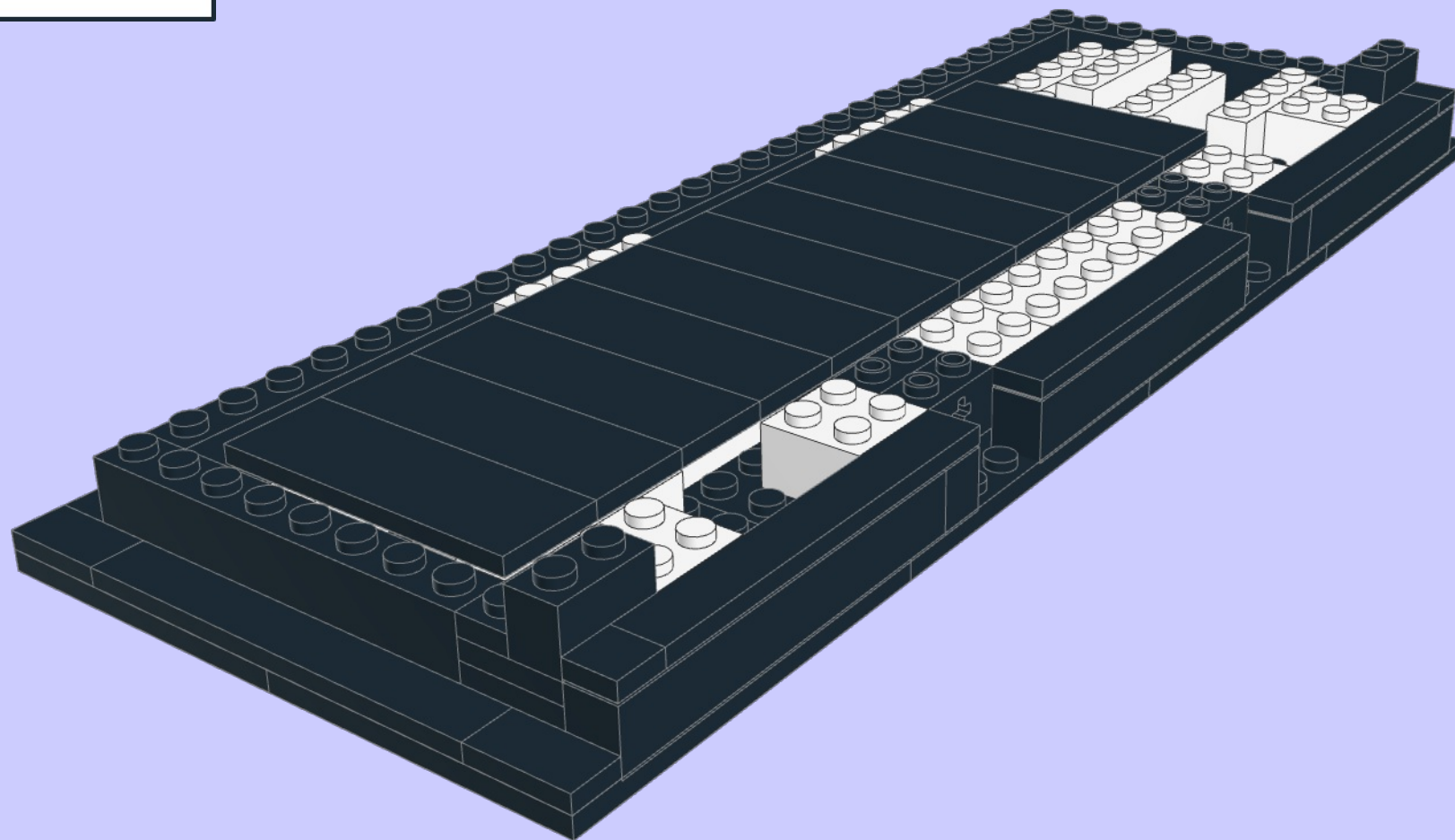
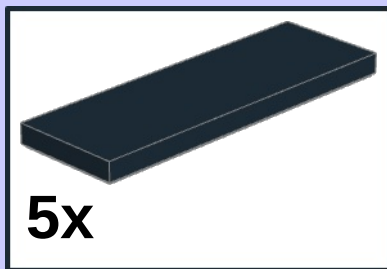

36

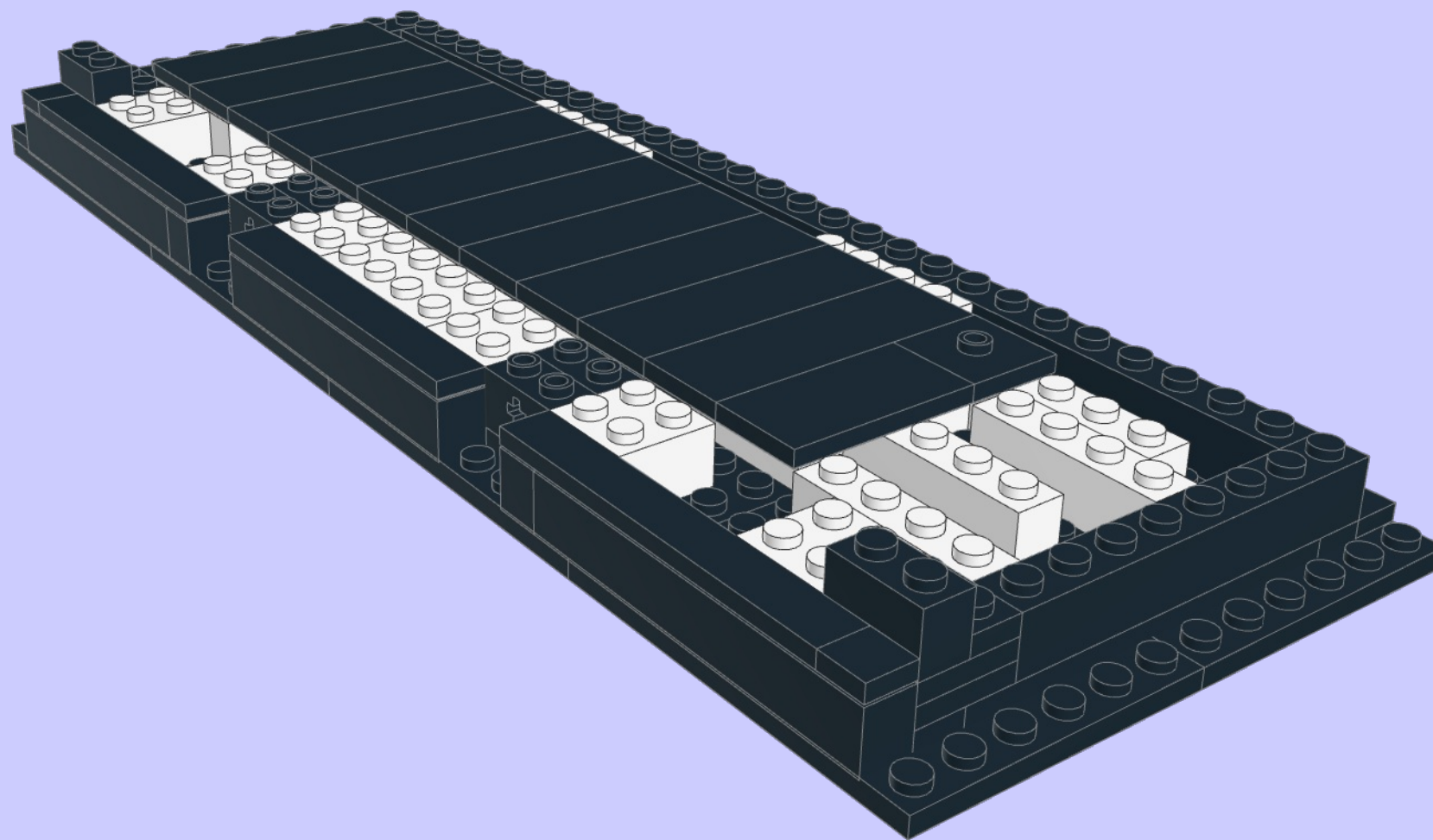
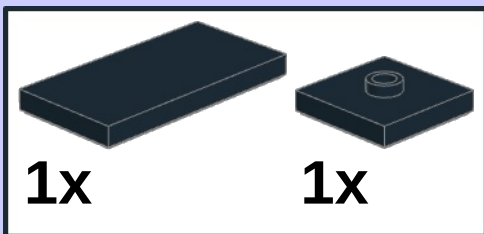

37

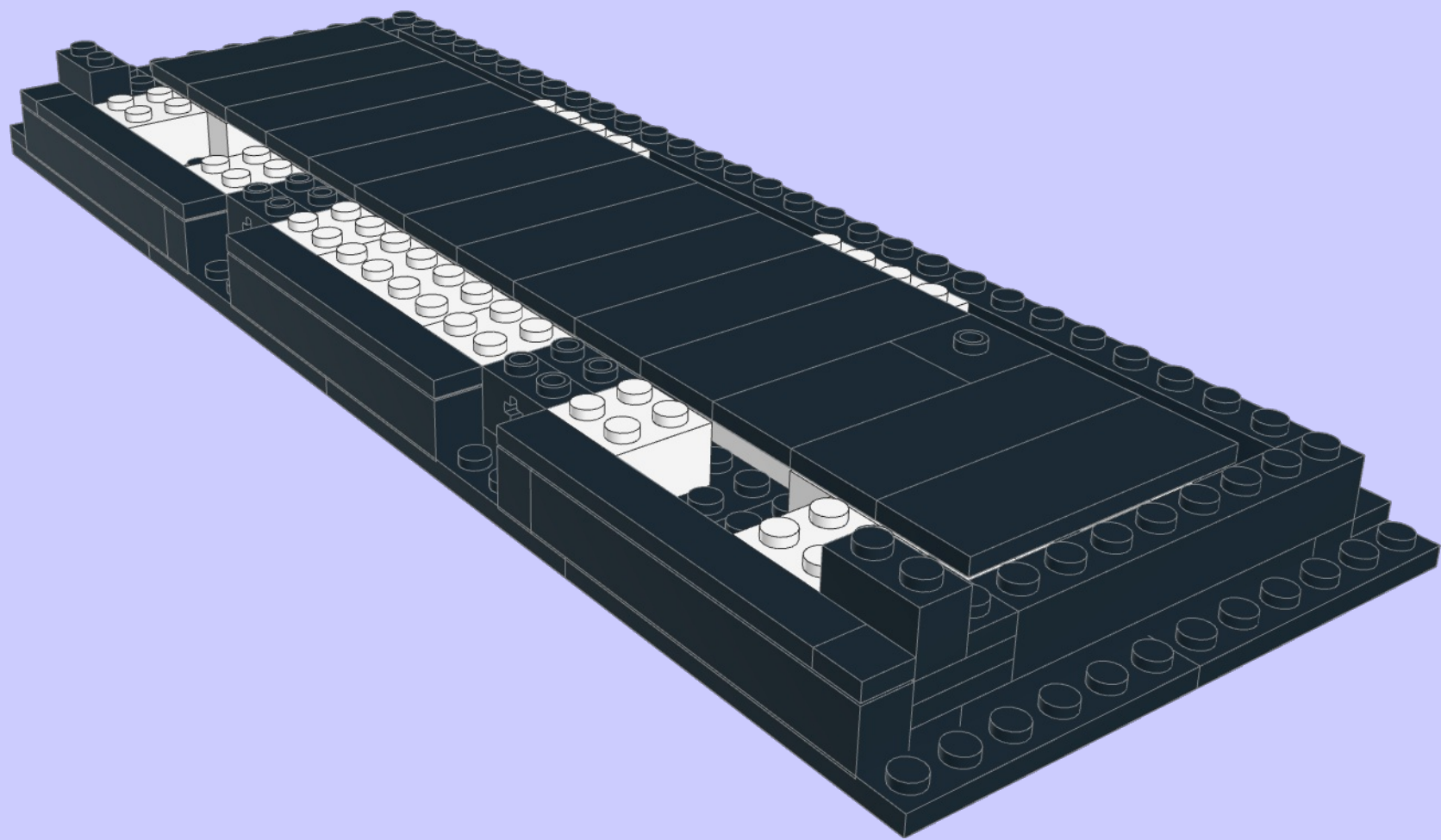
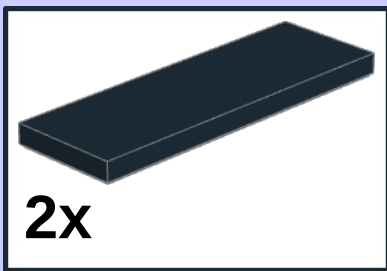

38

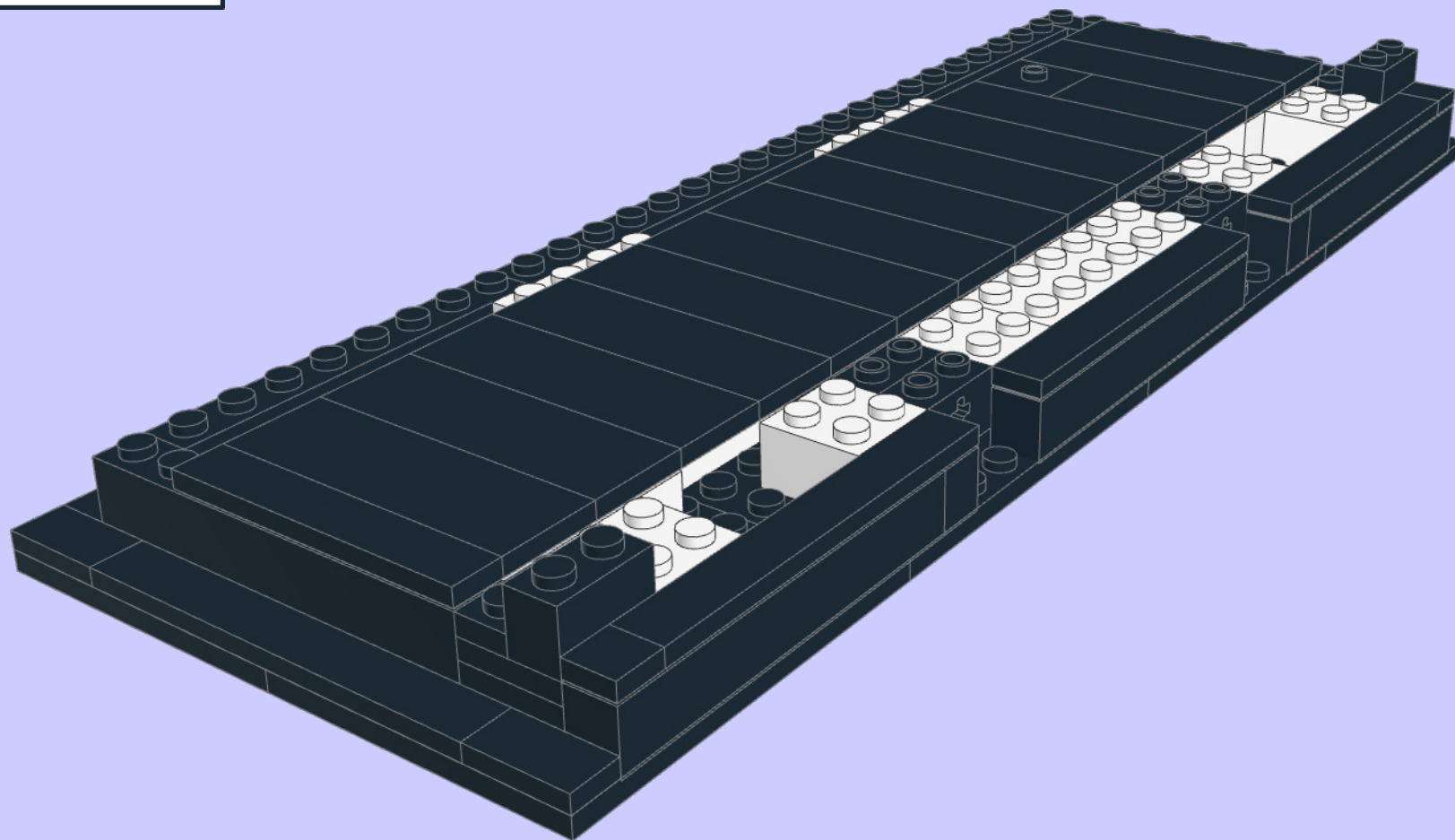
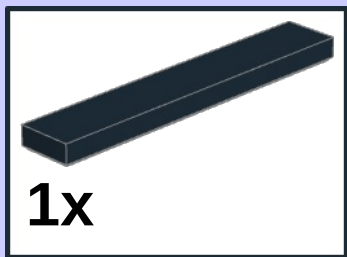

39

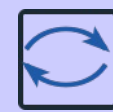
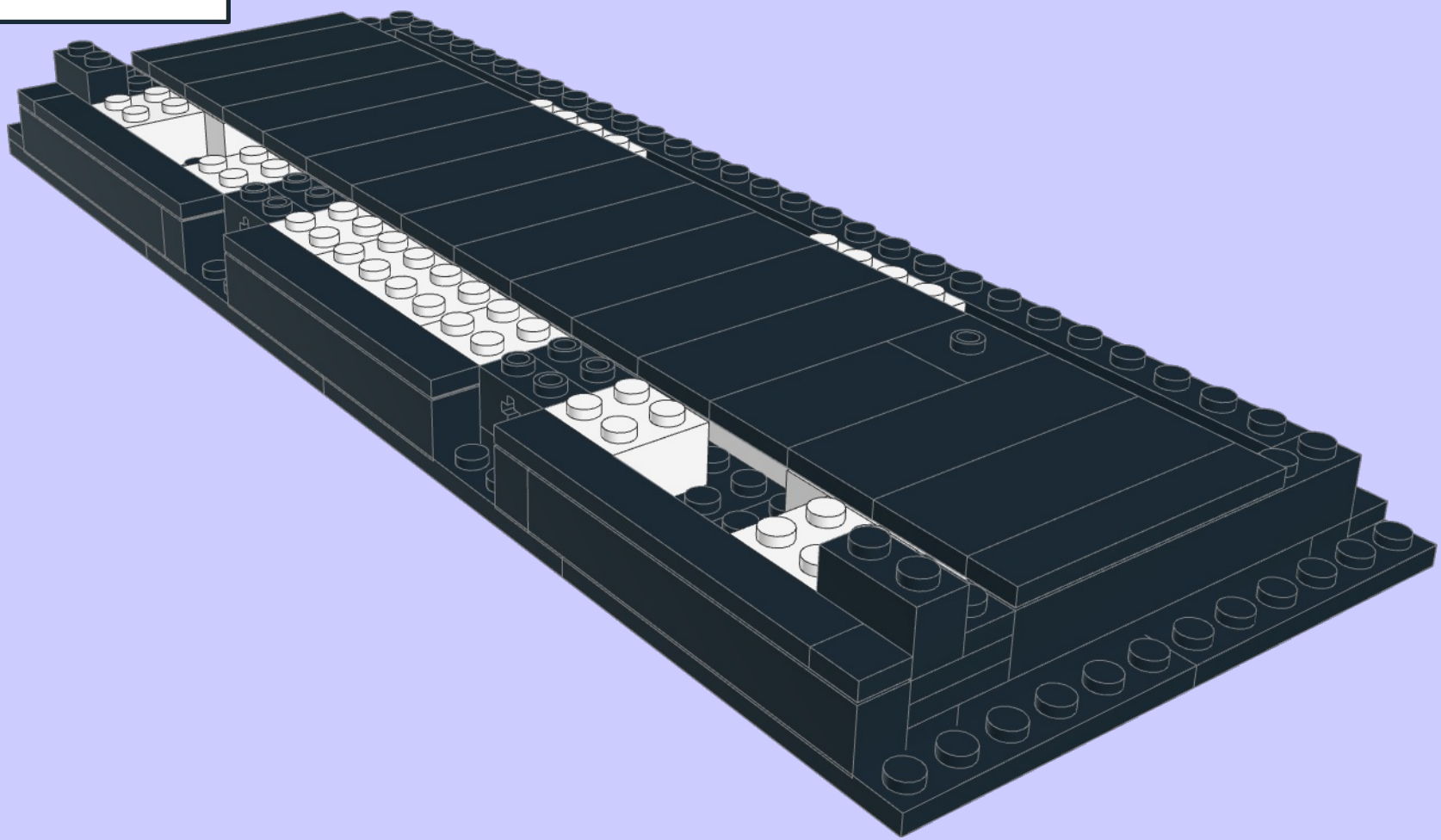
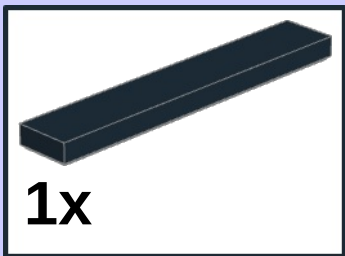

40

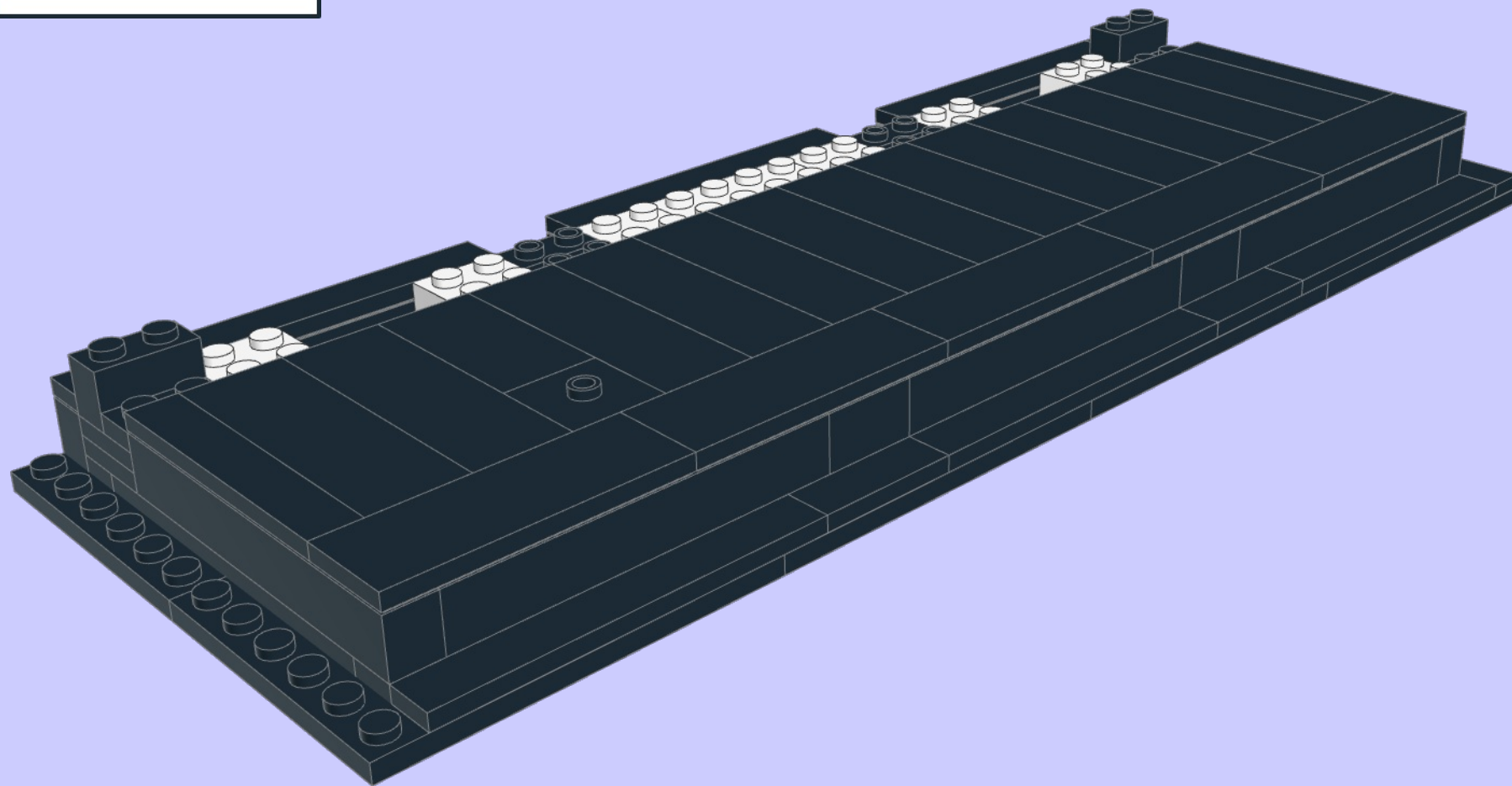
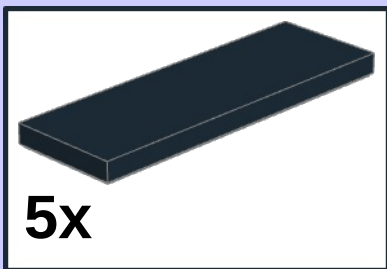

41

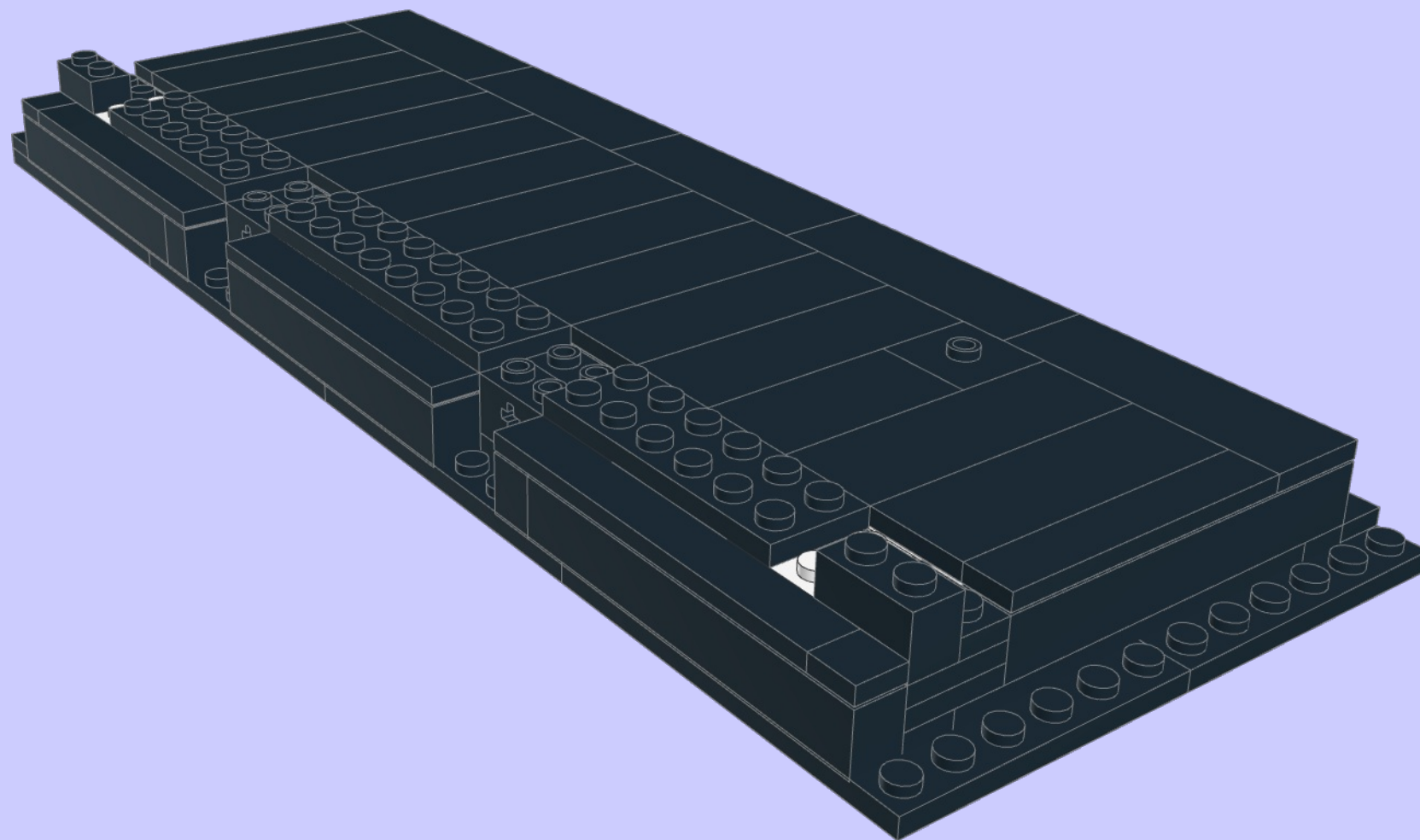
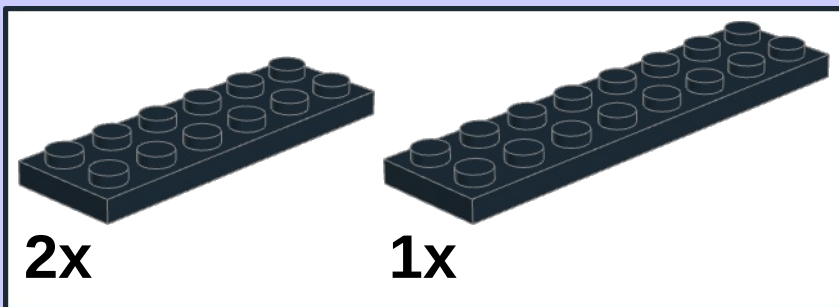

42

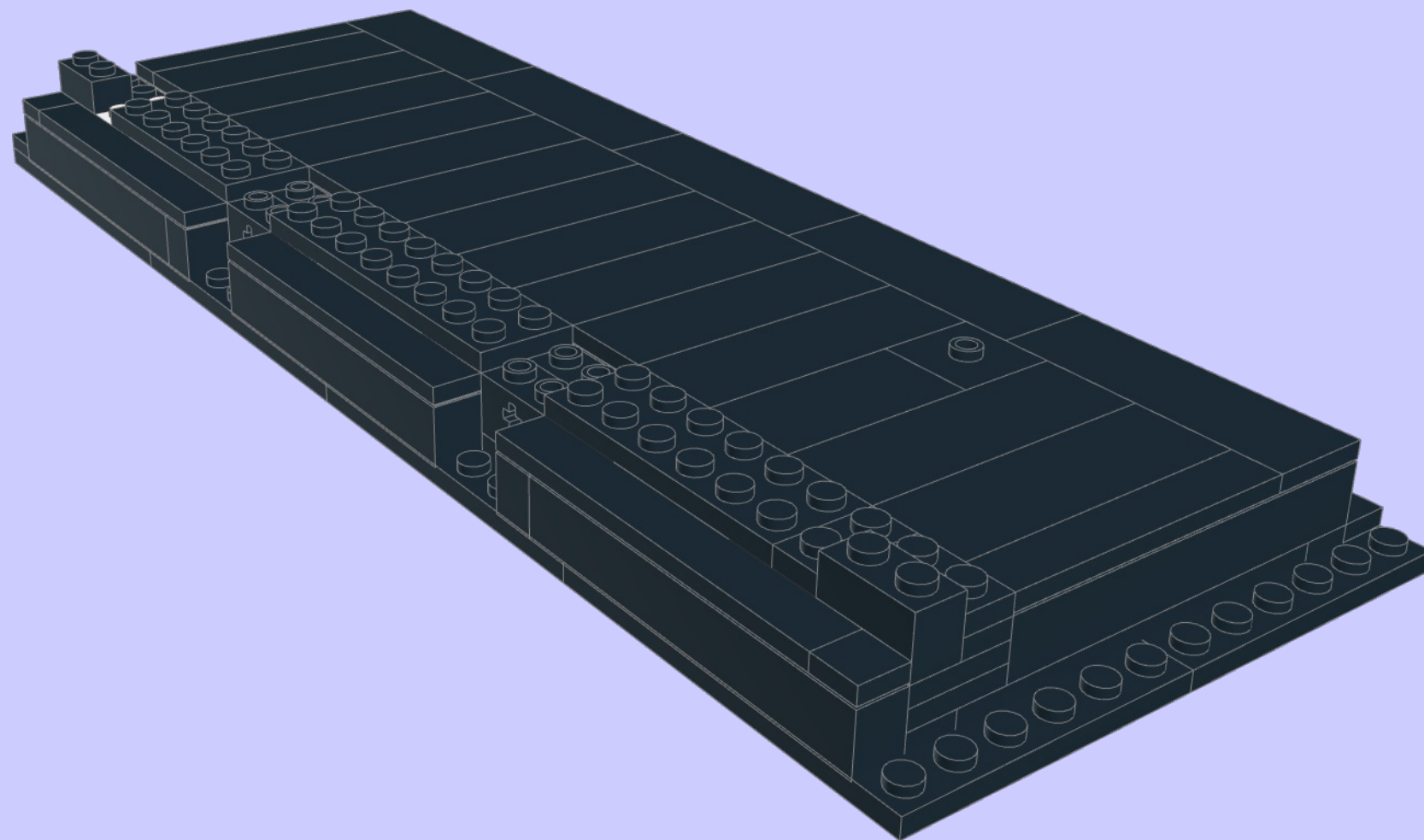

43

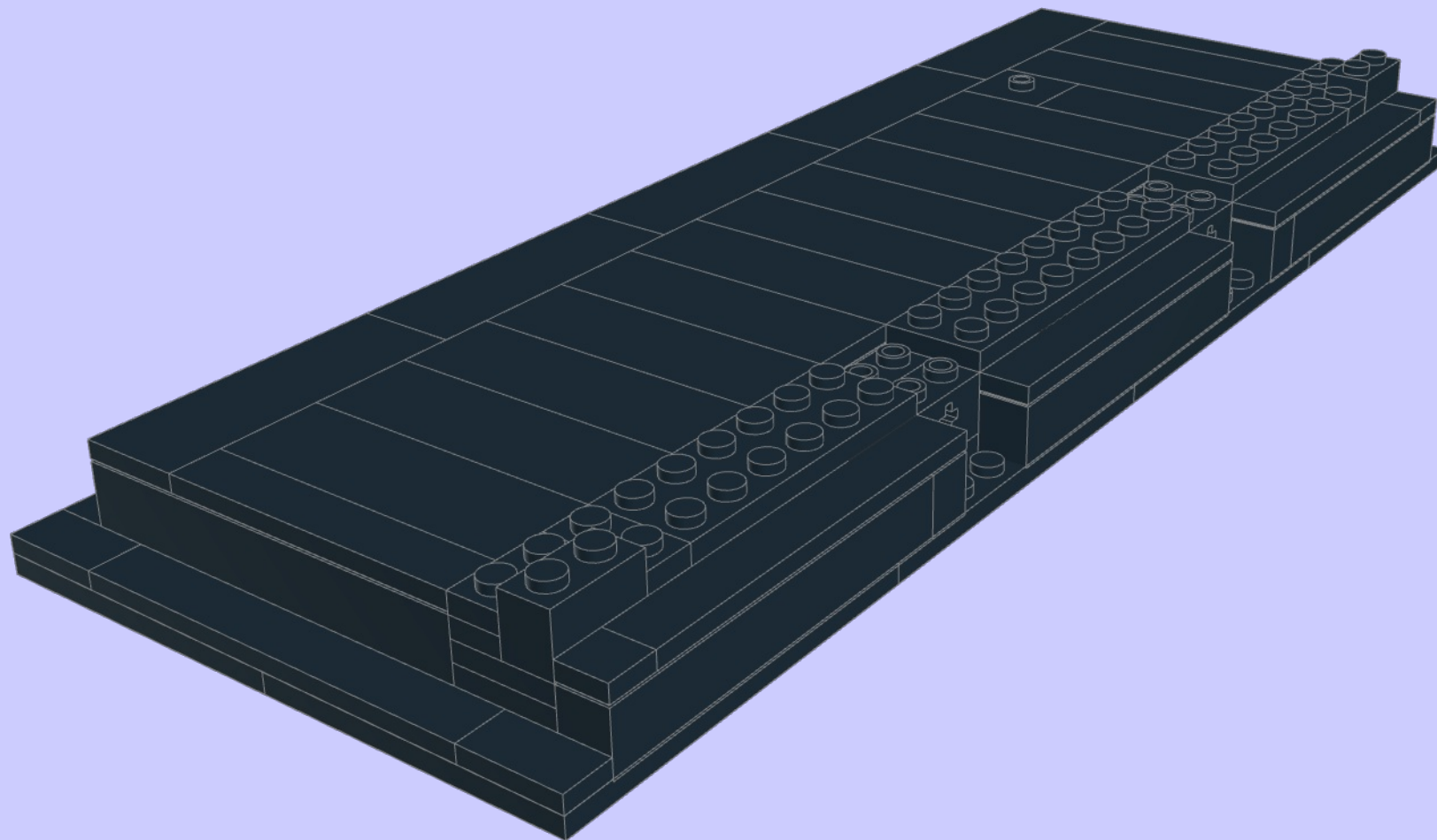

44

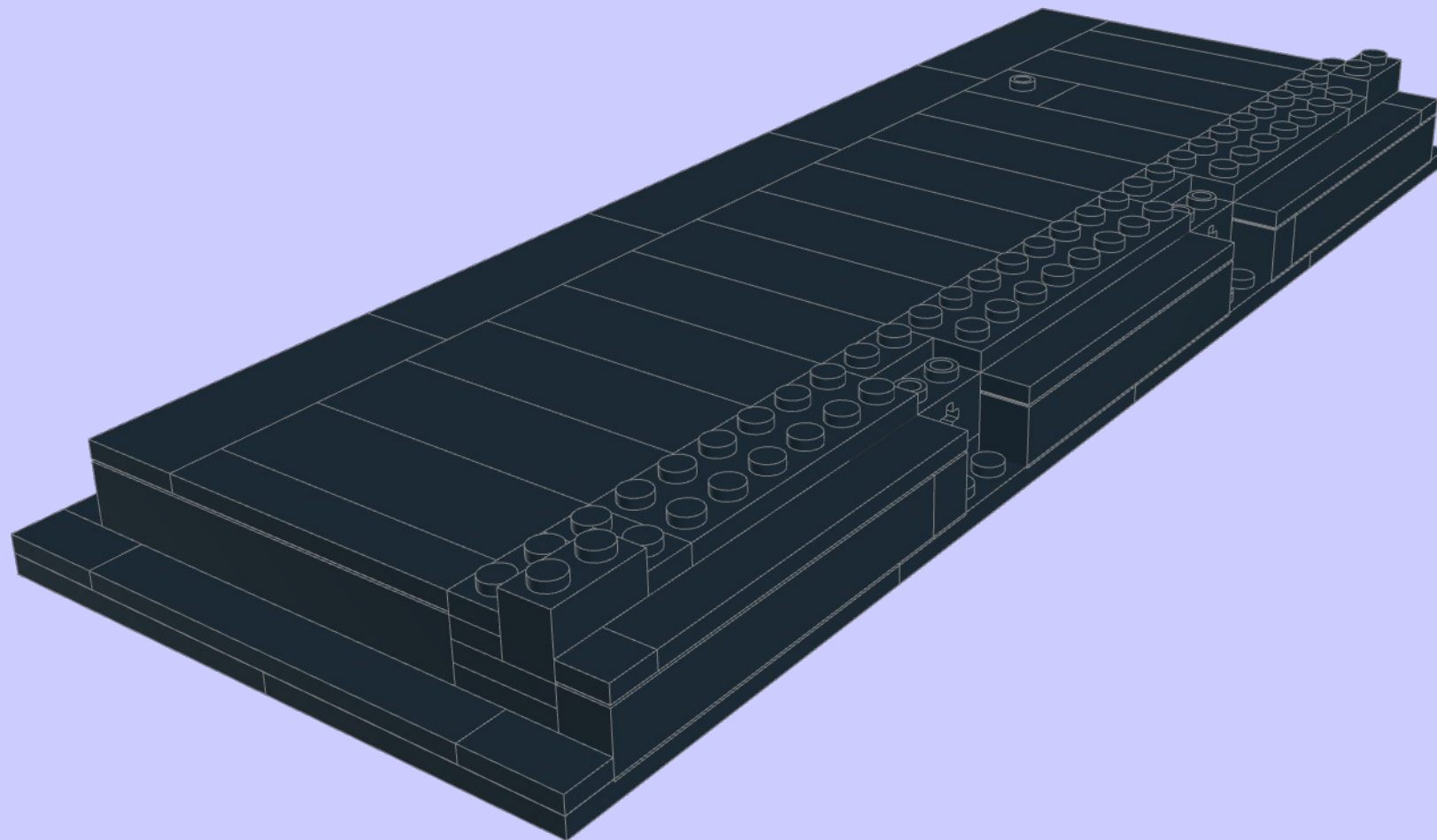

45

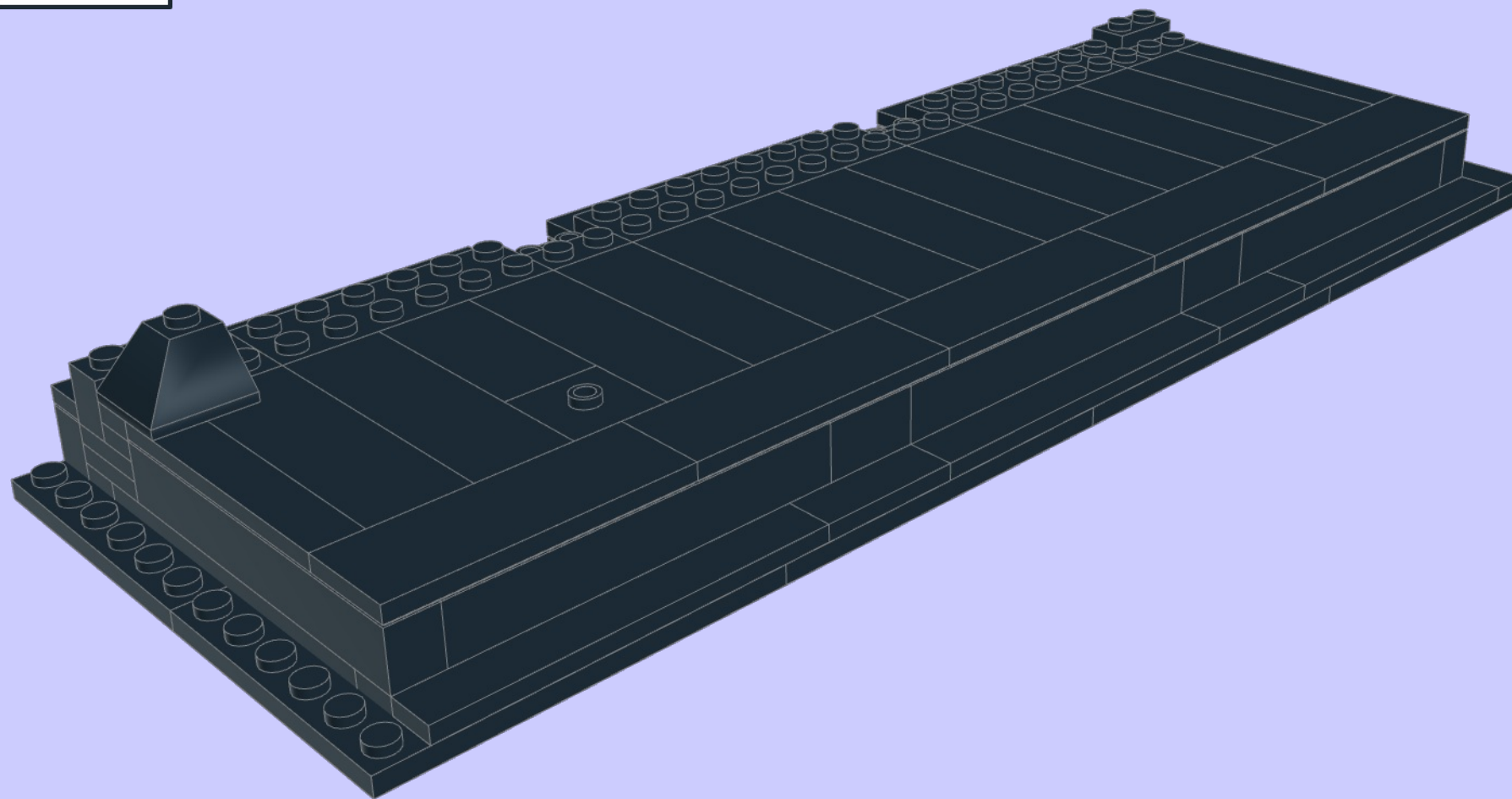

46

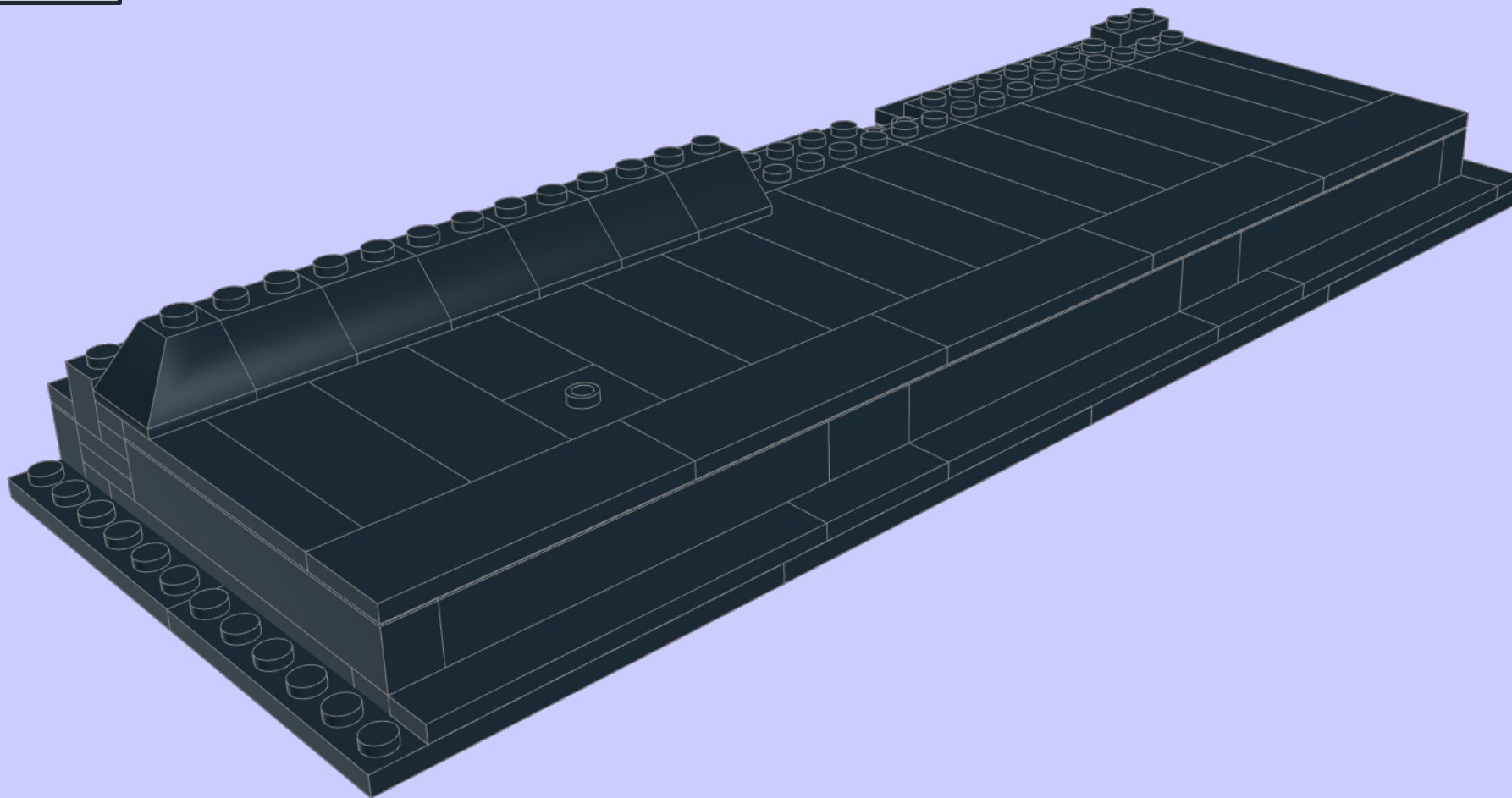

47

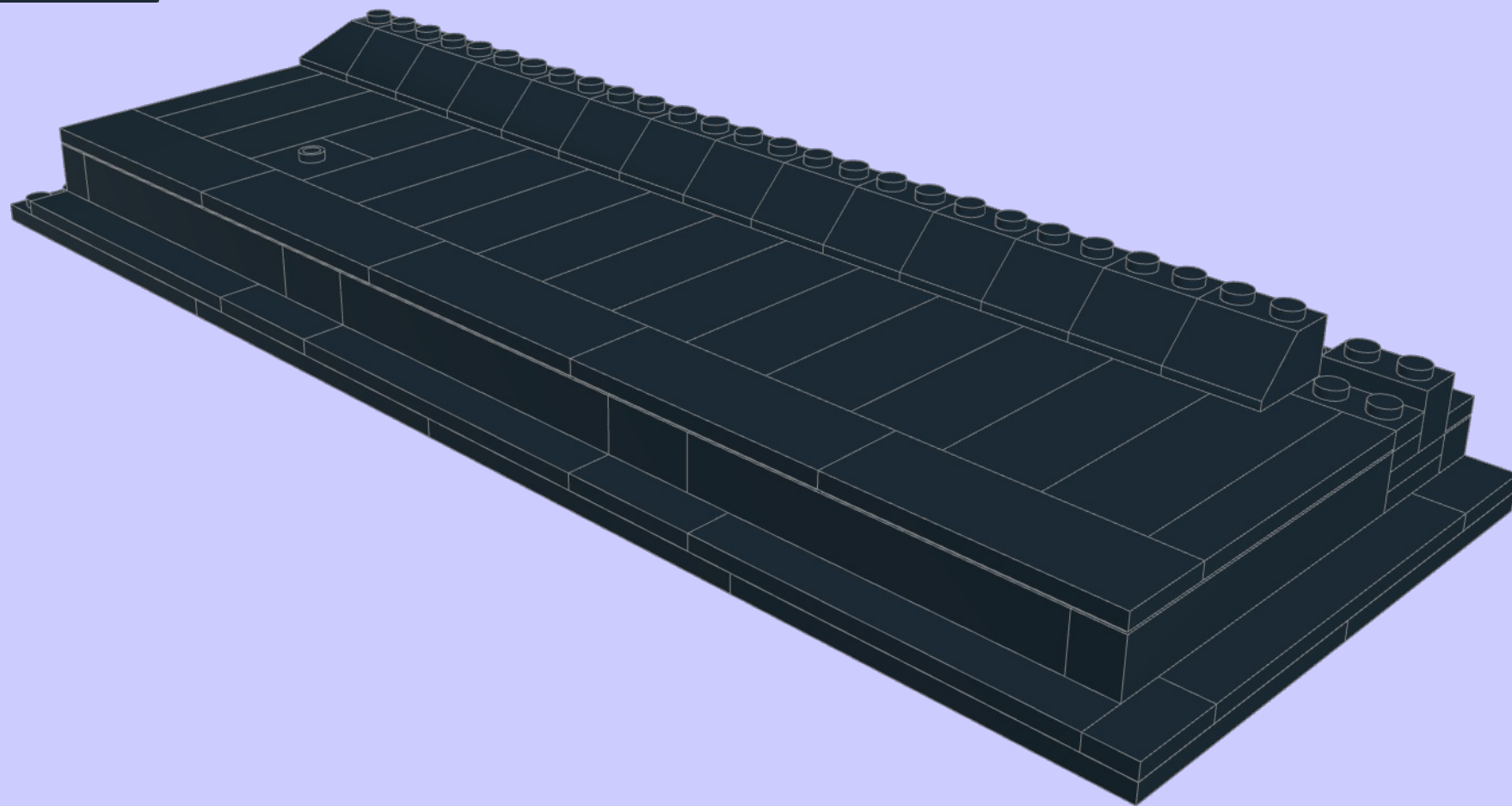

48

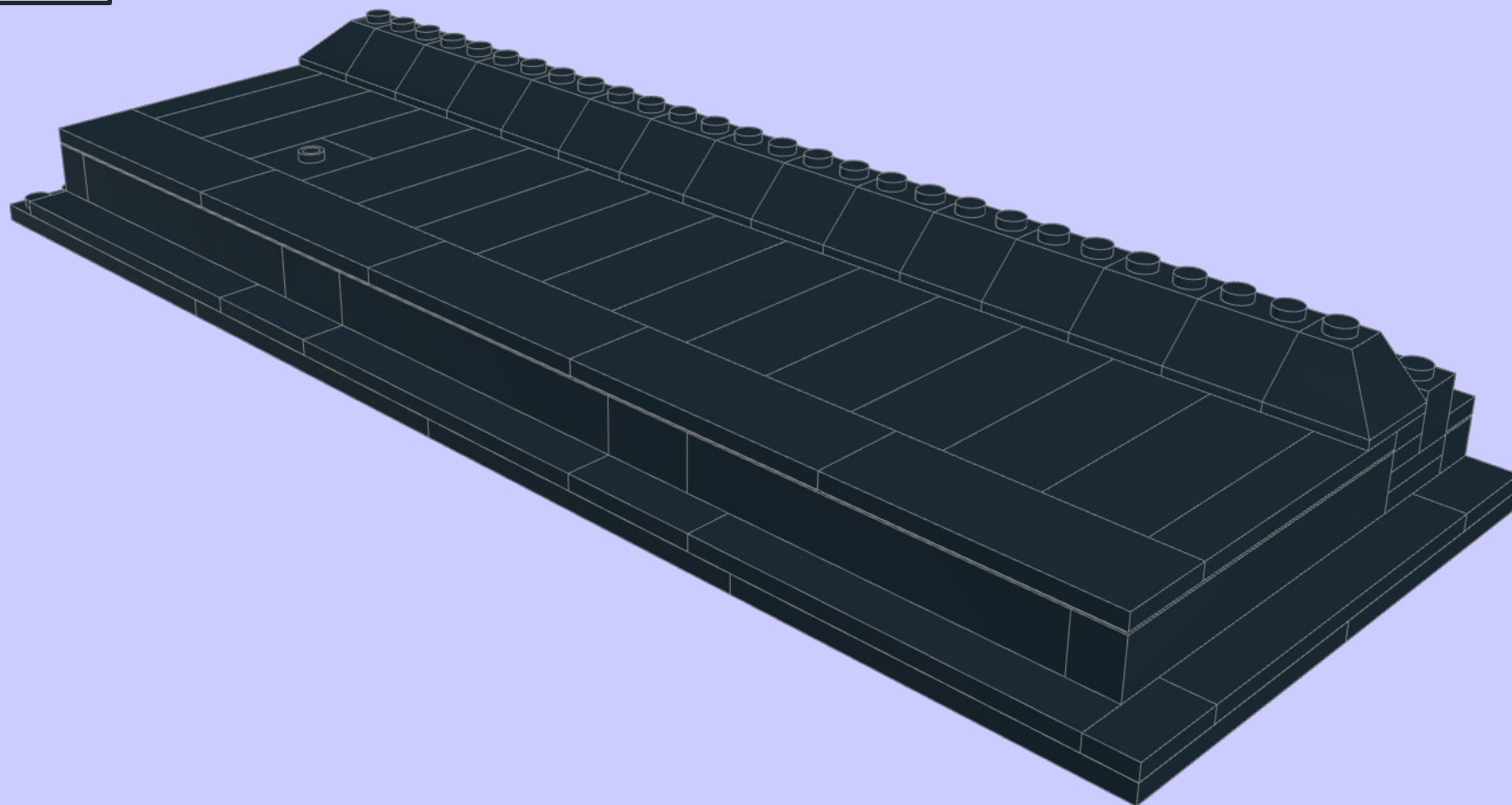

49

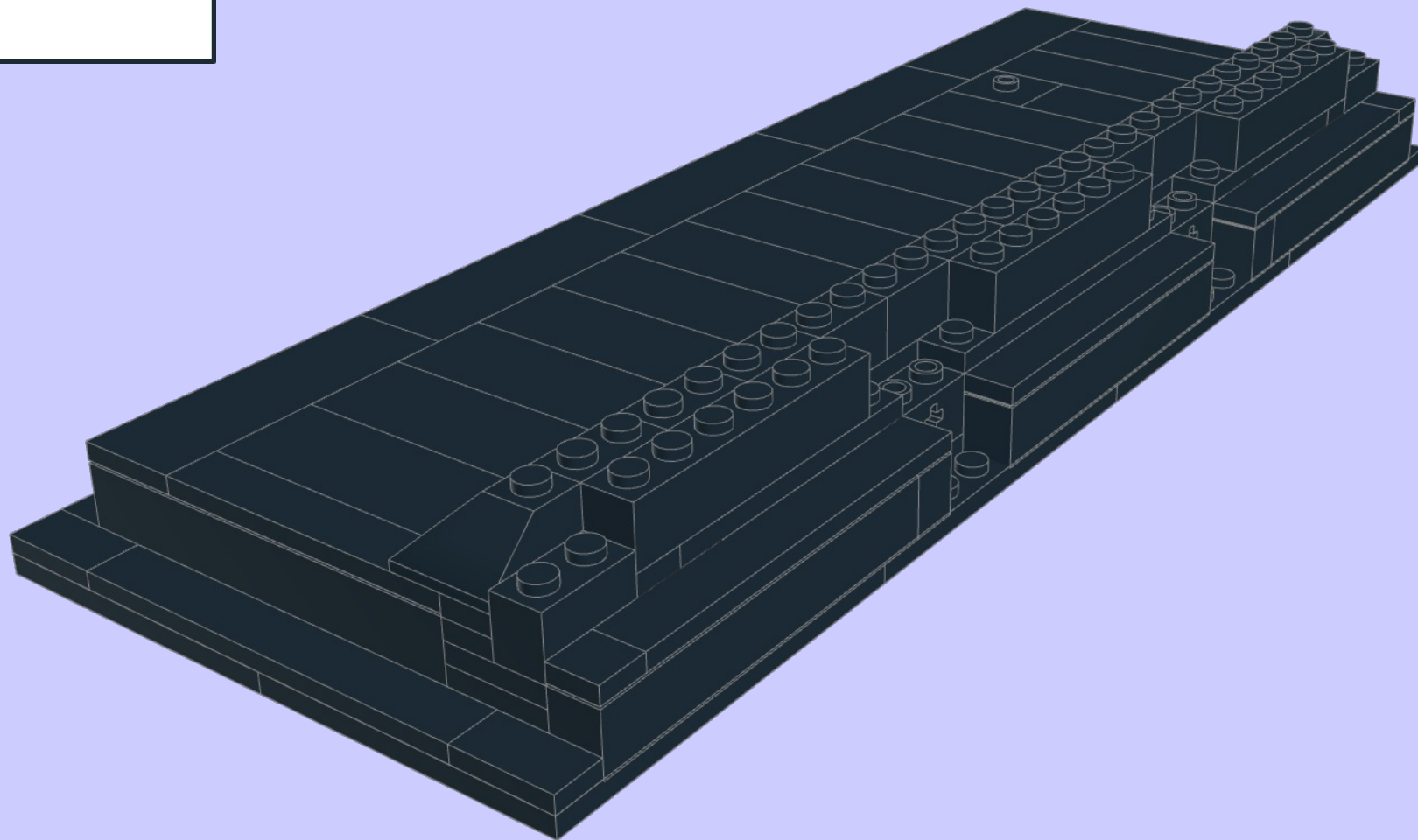
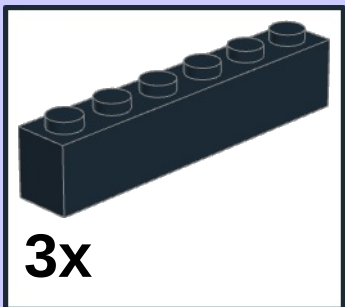

50

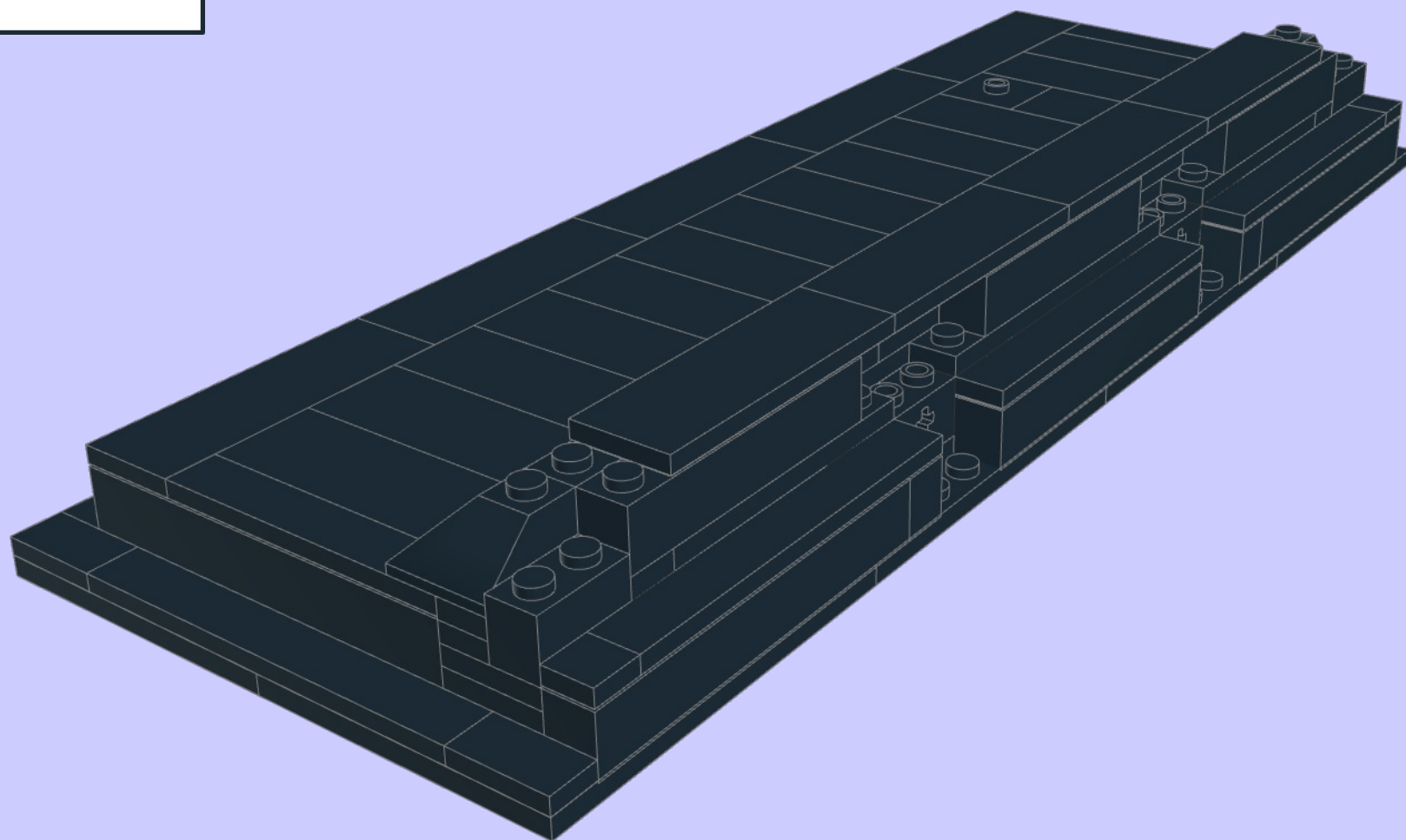
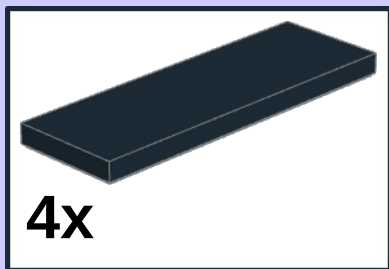

51

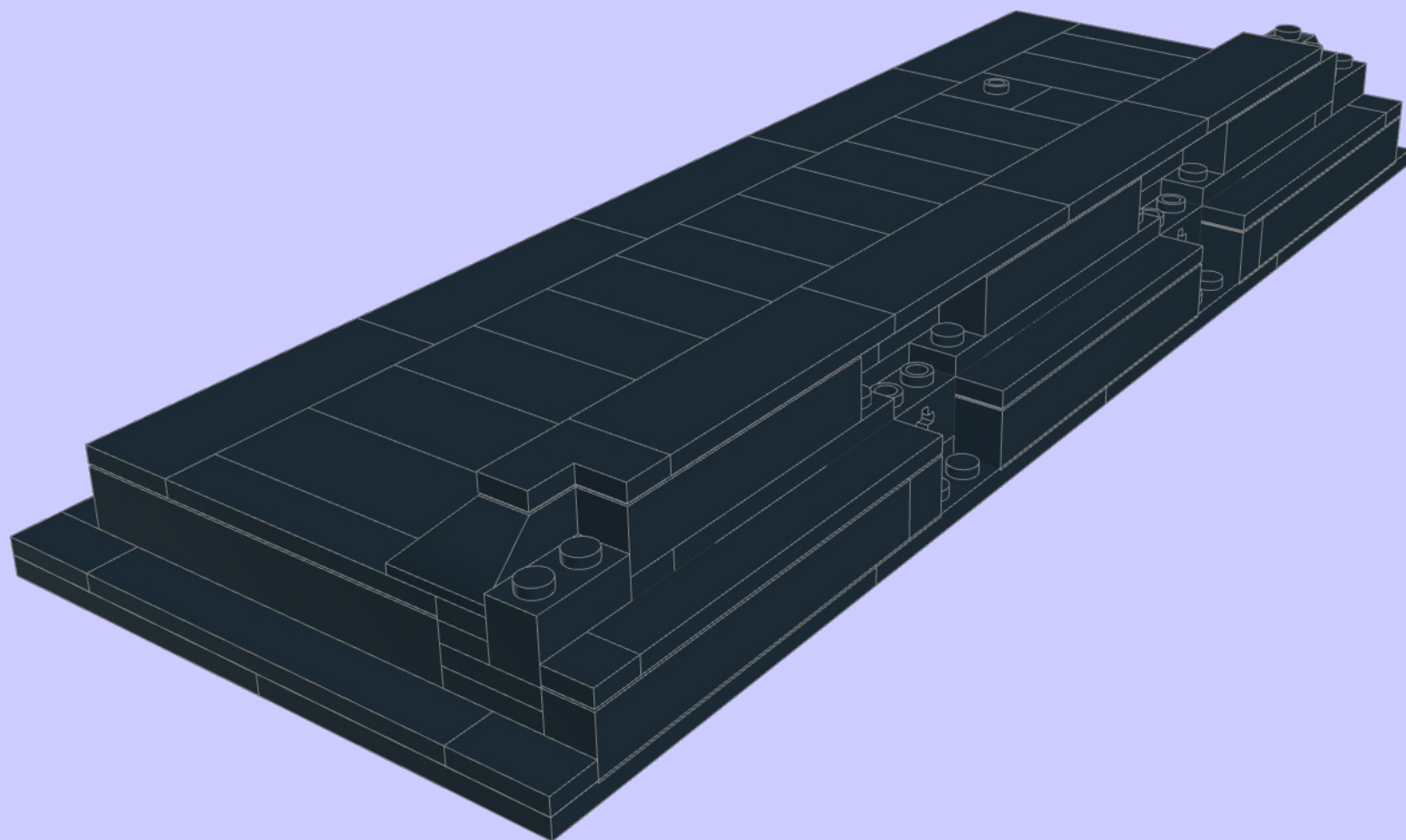
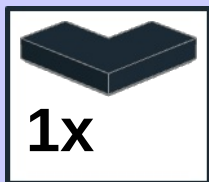

52

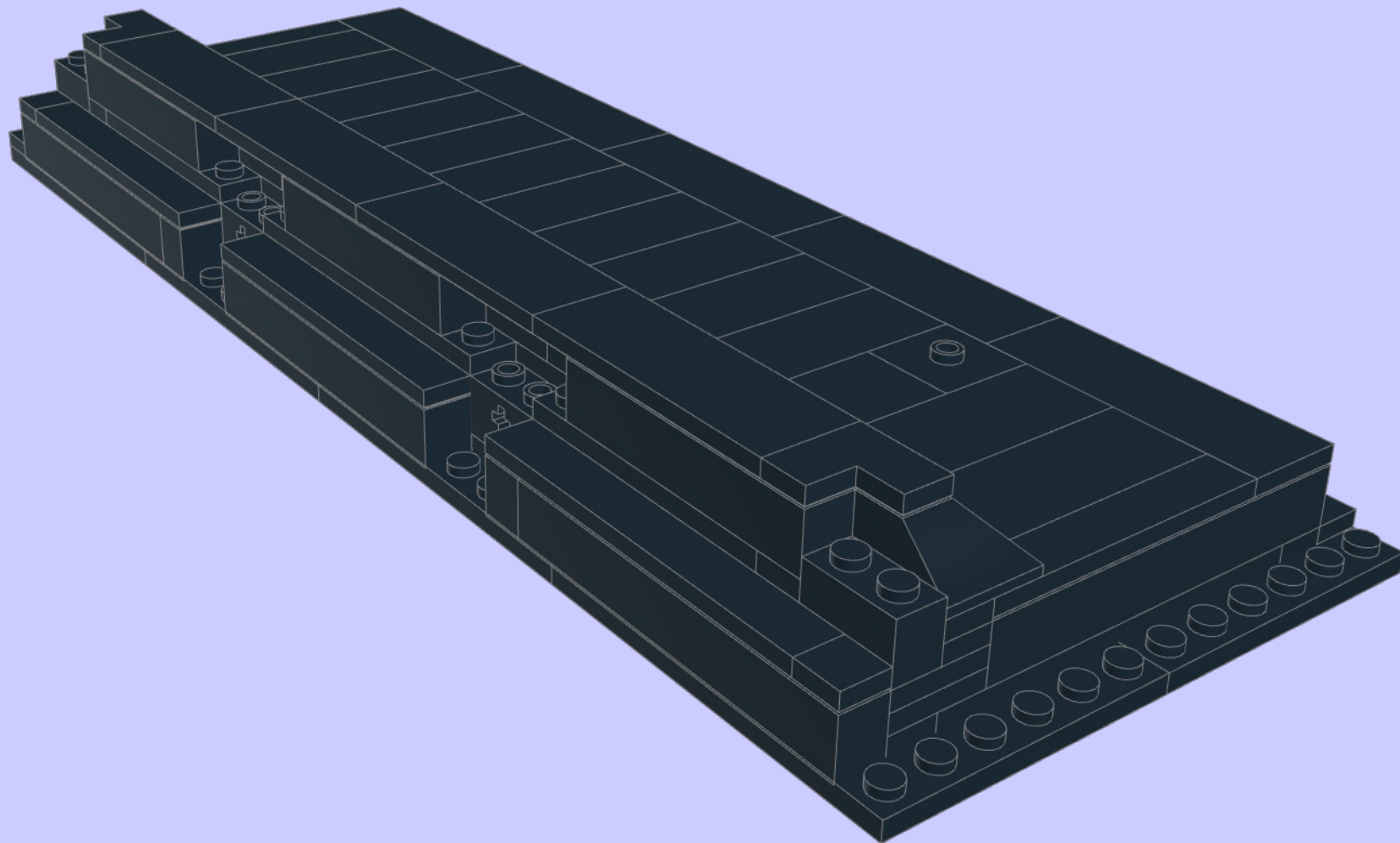
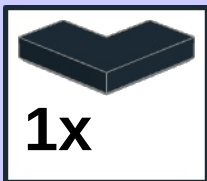

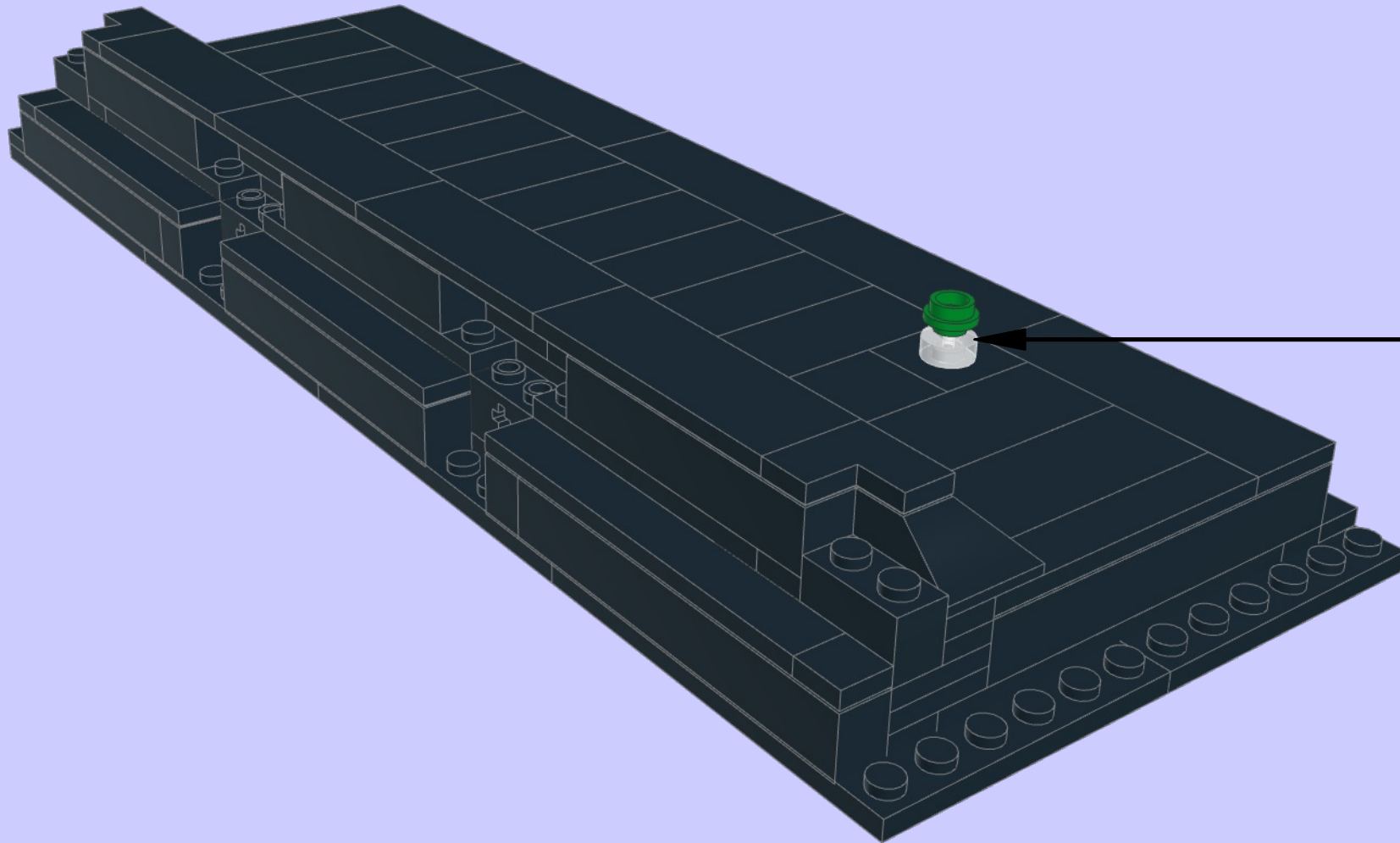

1		1x
		
2		1x
		

1

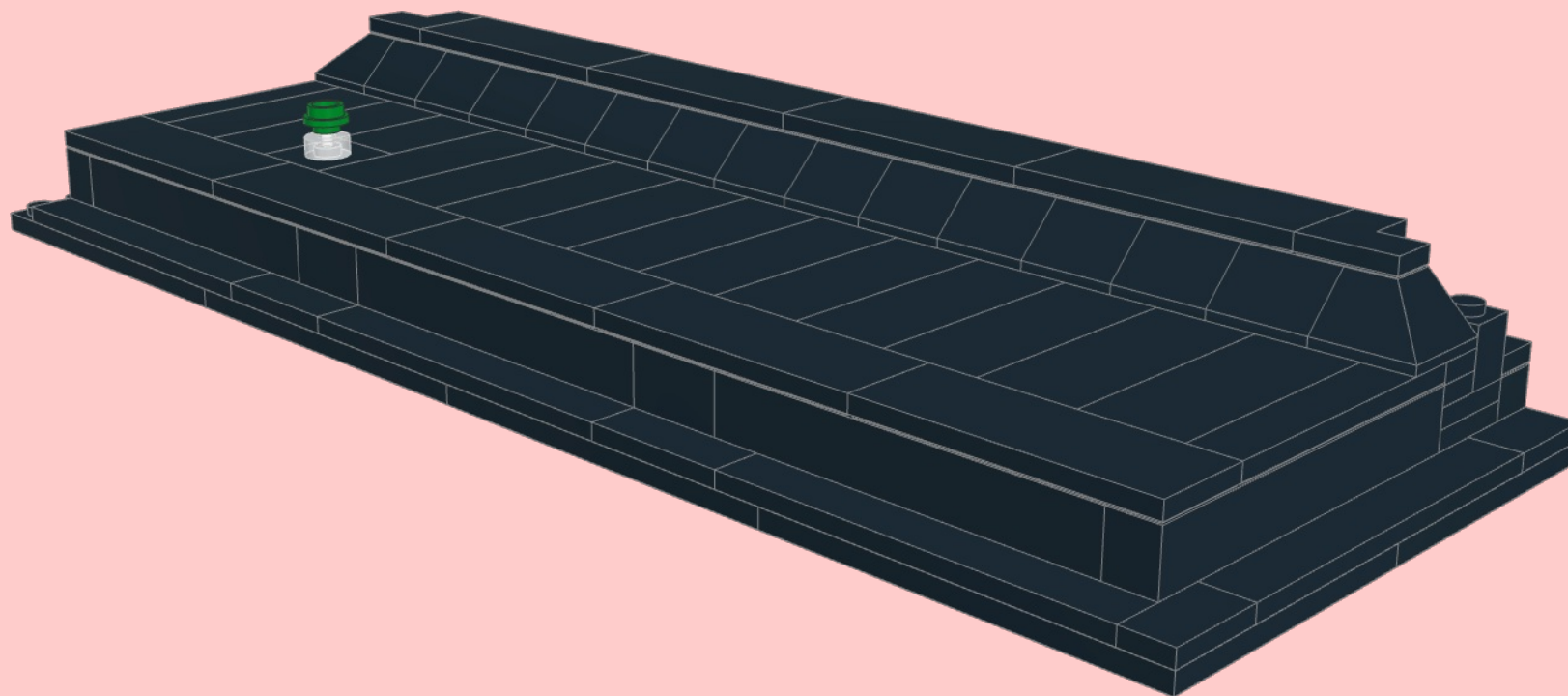

1

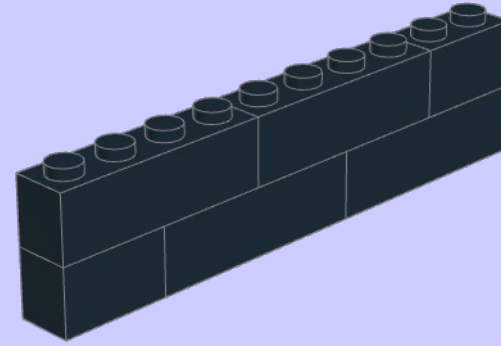
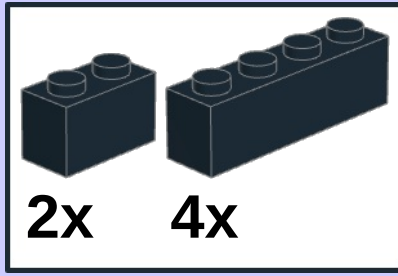

2

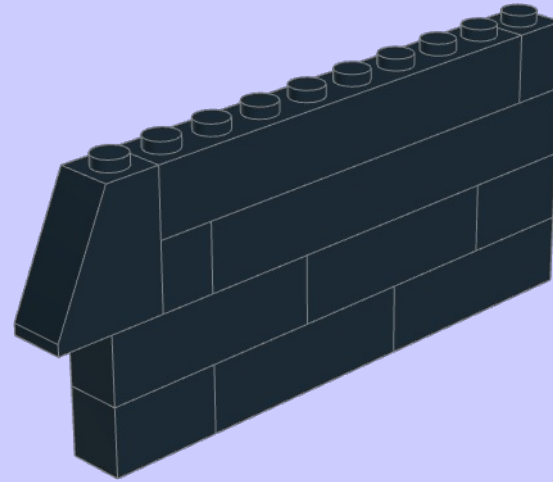
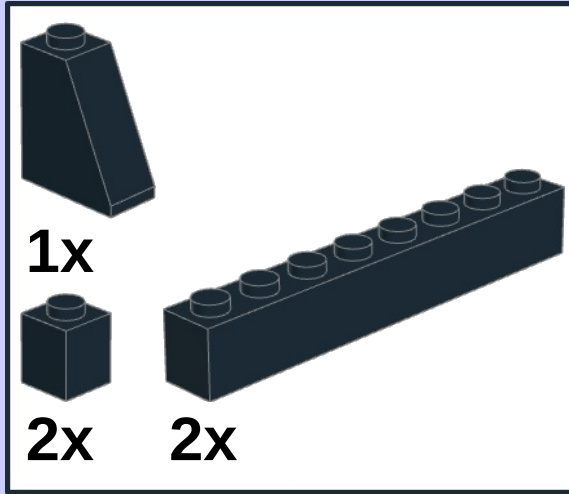

3

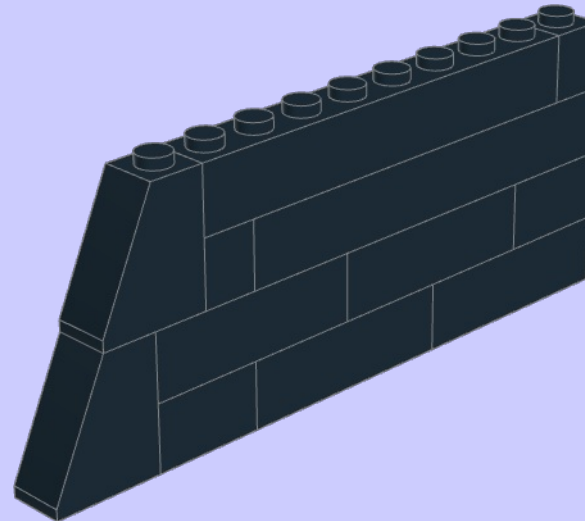
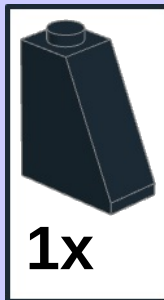

4

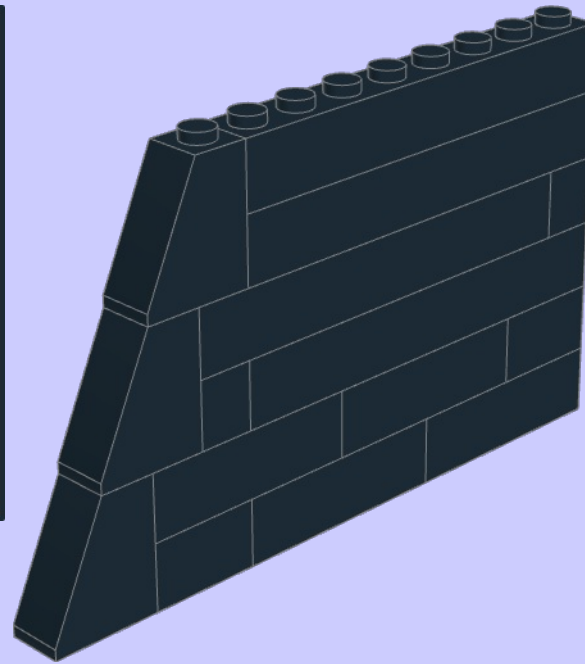
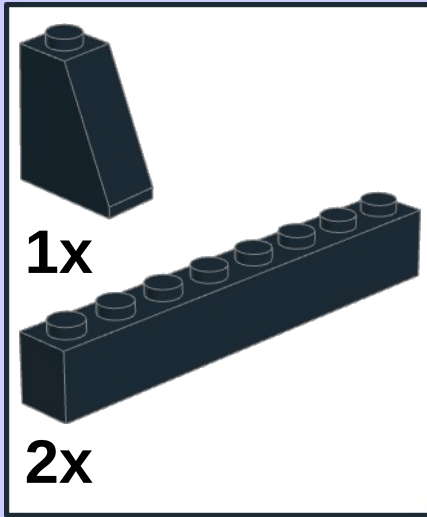

5

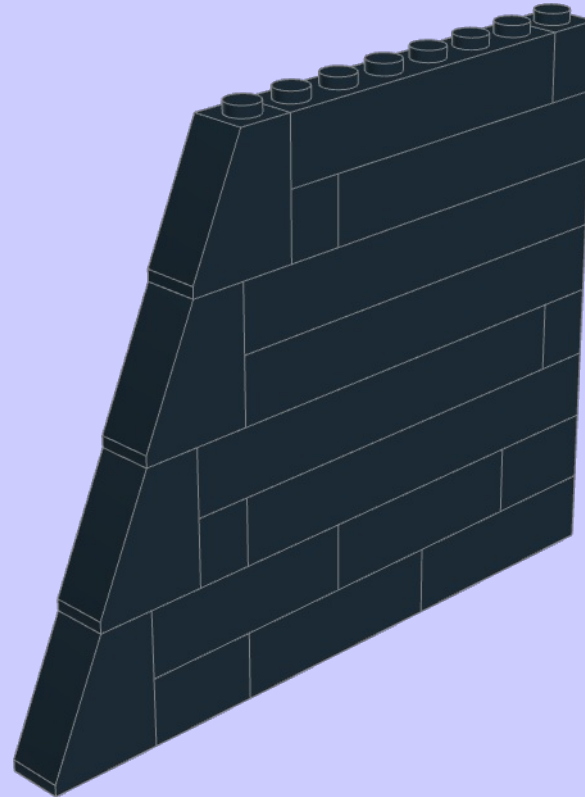
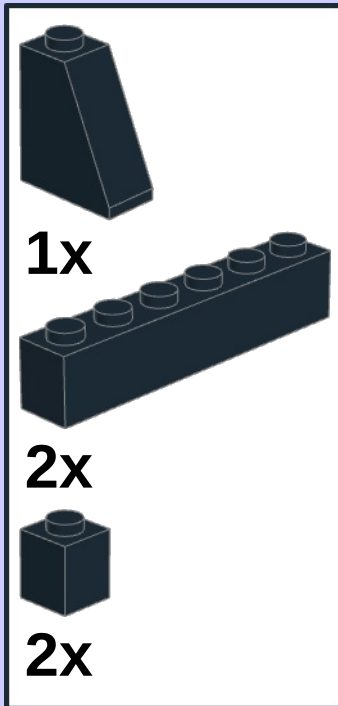

6

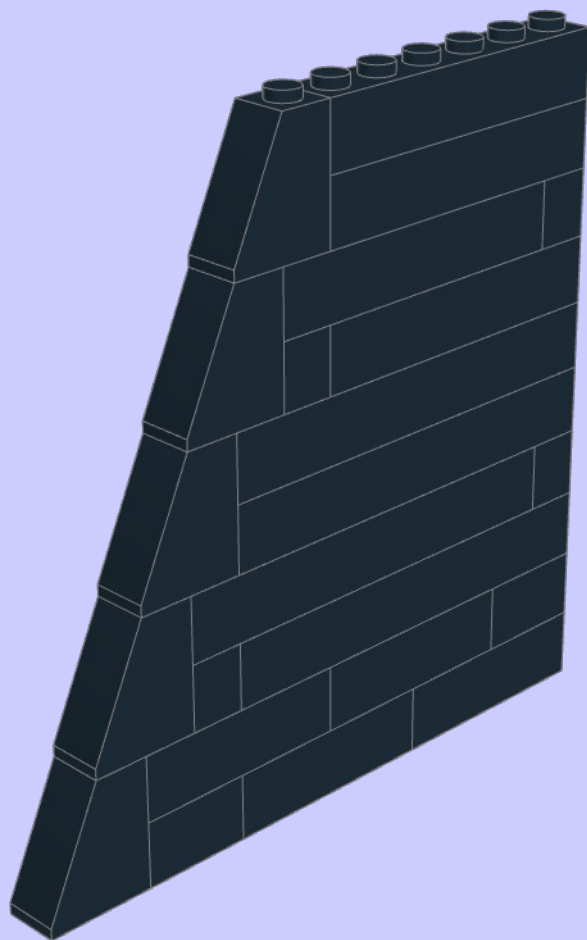
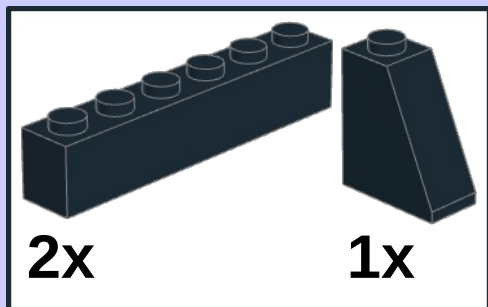

7

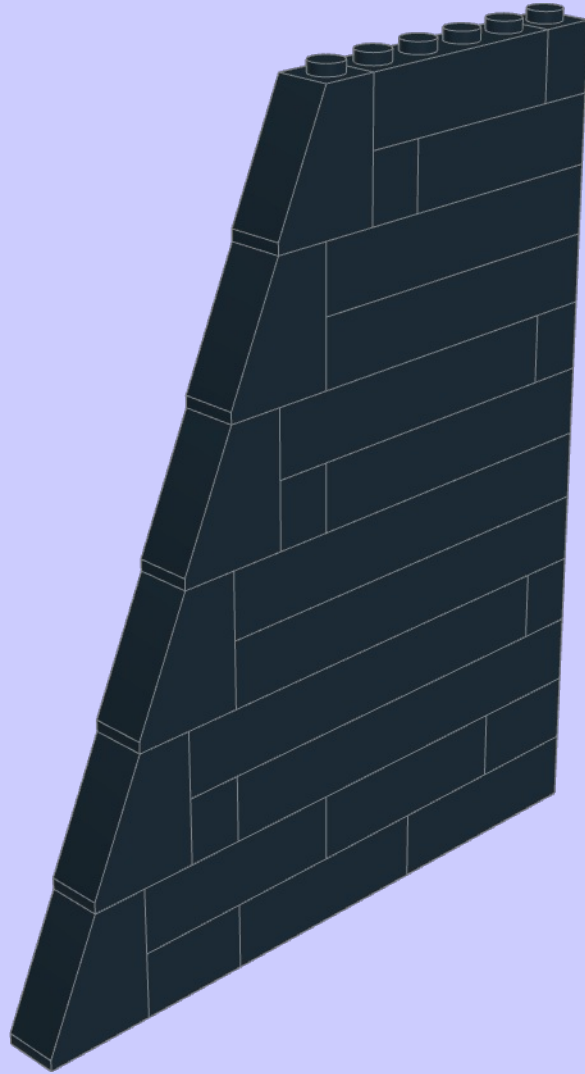
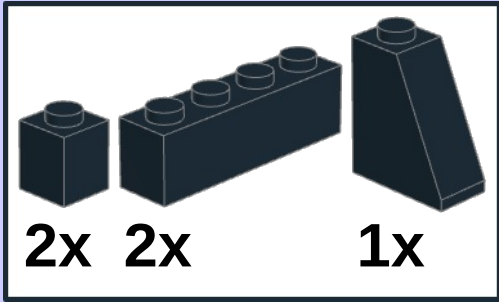

8

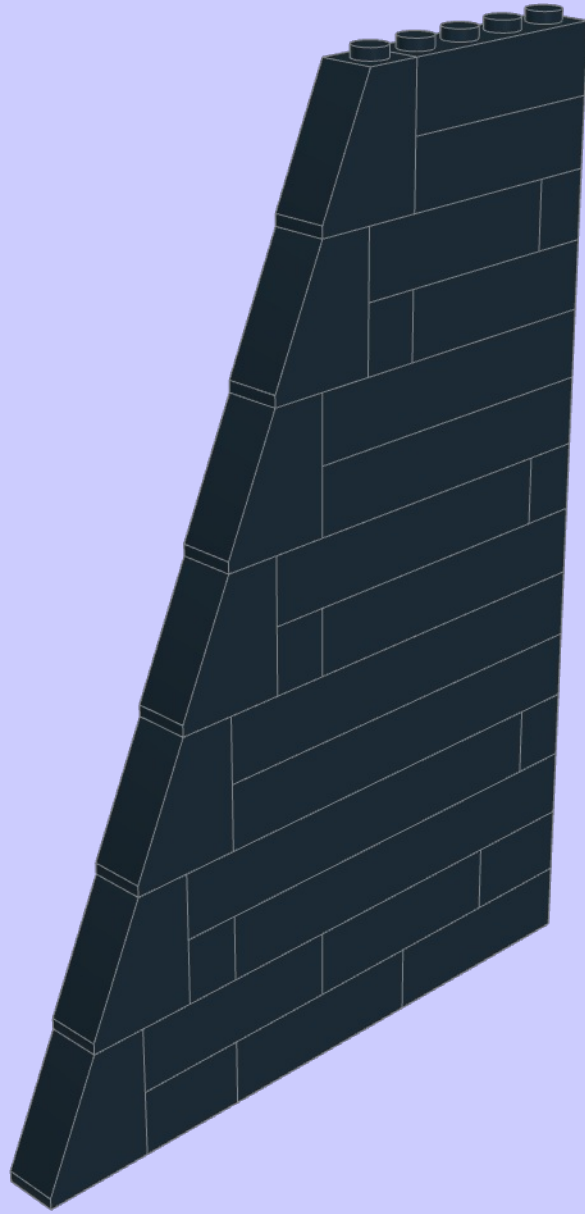
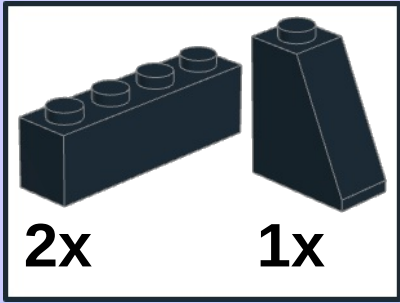

9

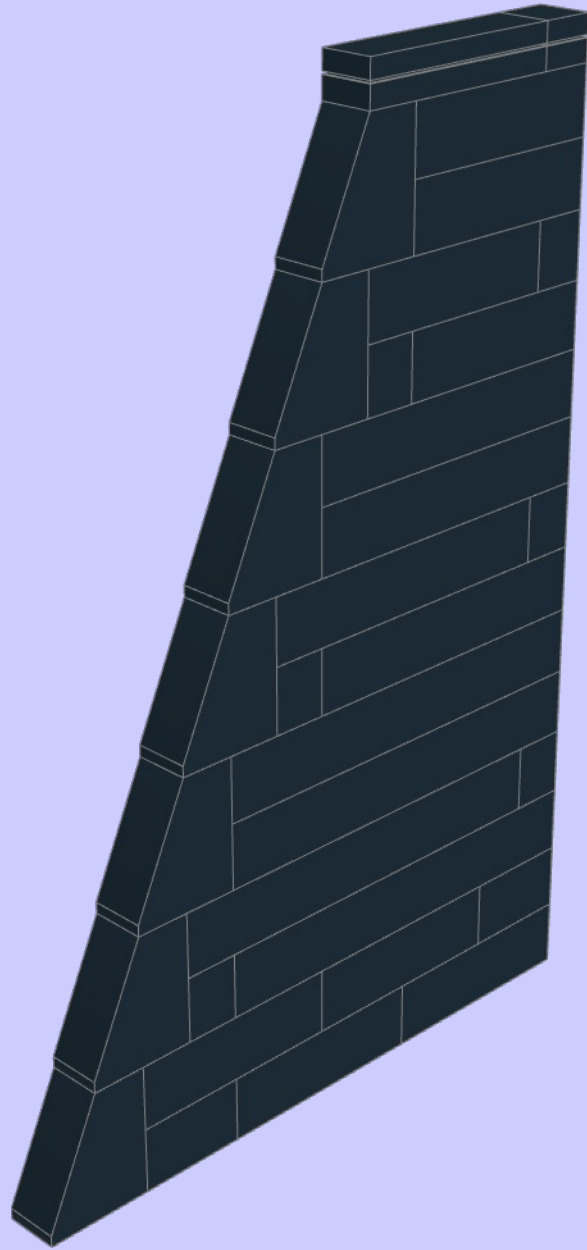
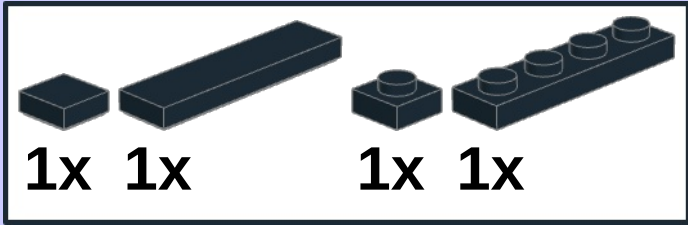

2

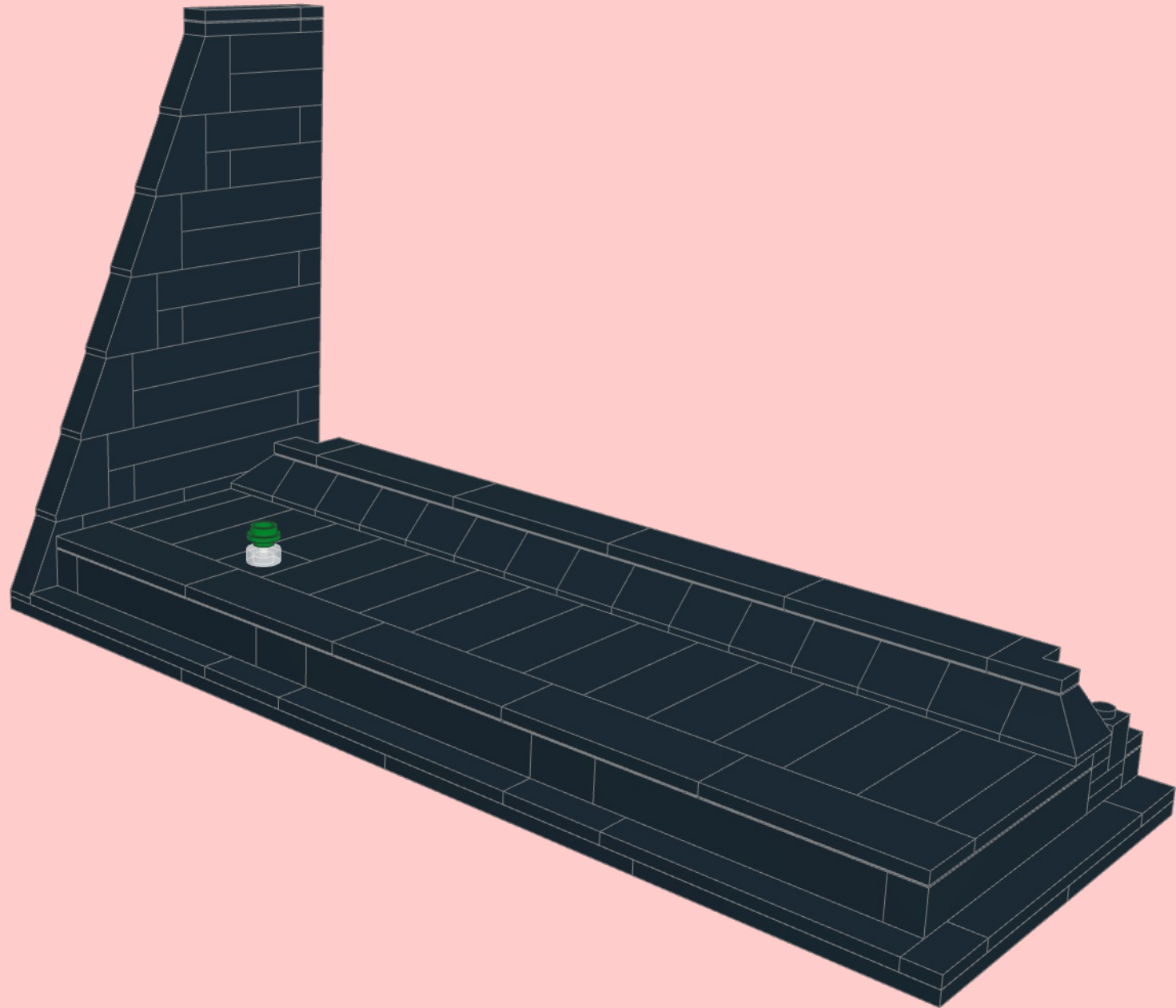

1

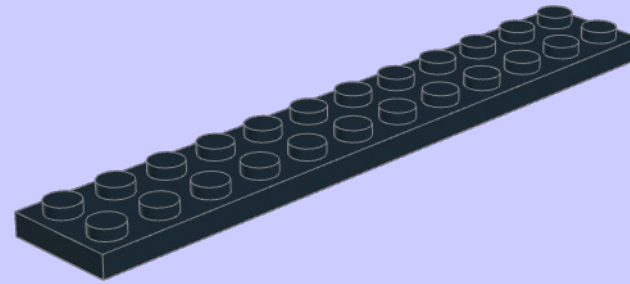
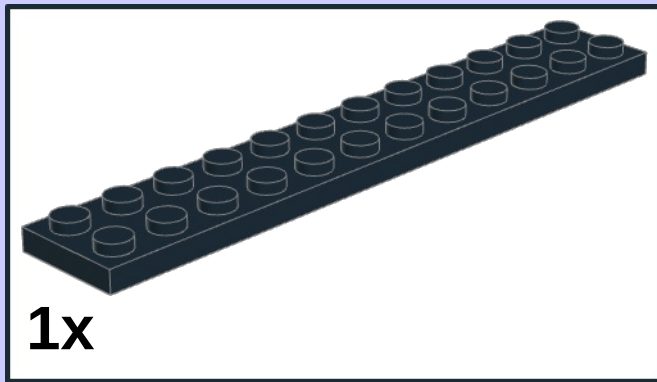

2

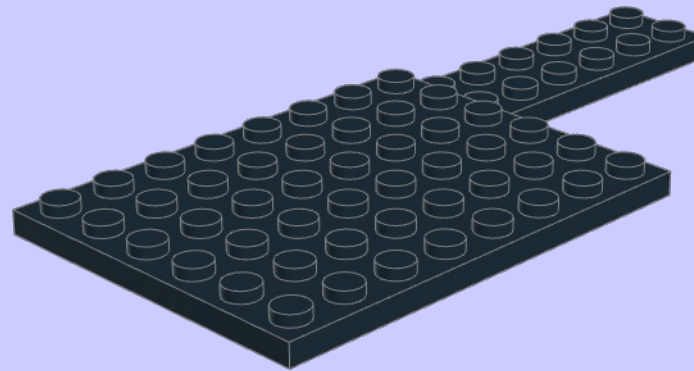
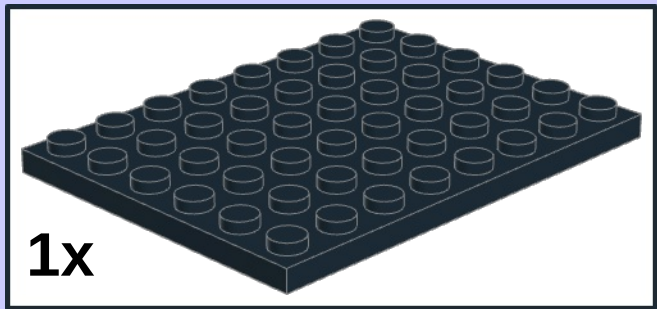

3

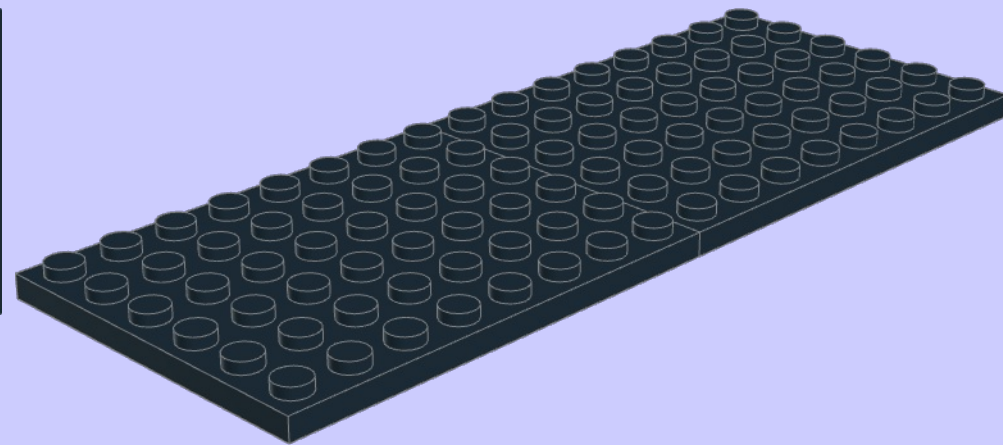
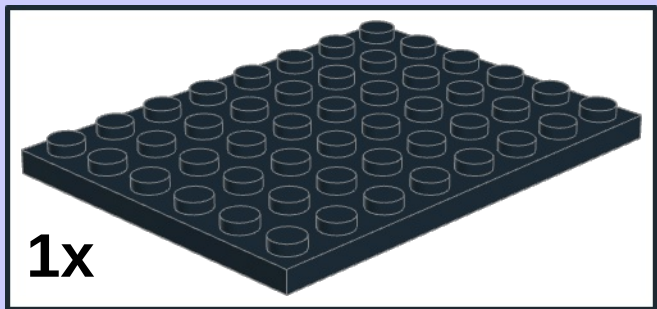

4

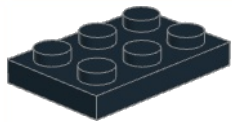

1x



1x

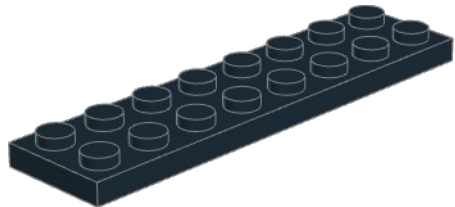

1x

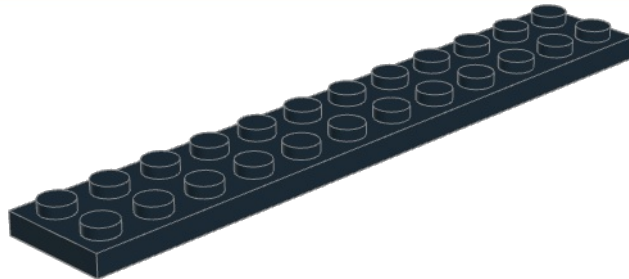

1x

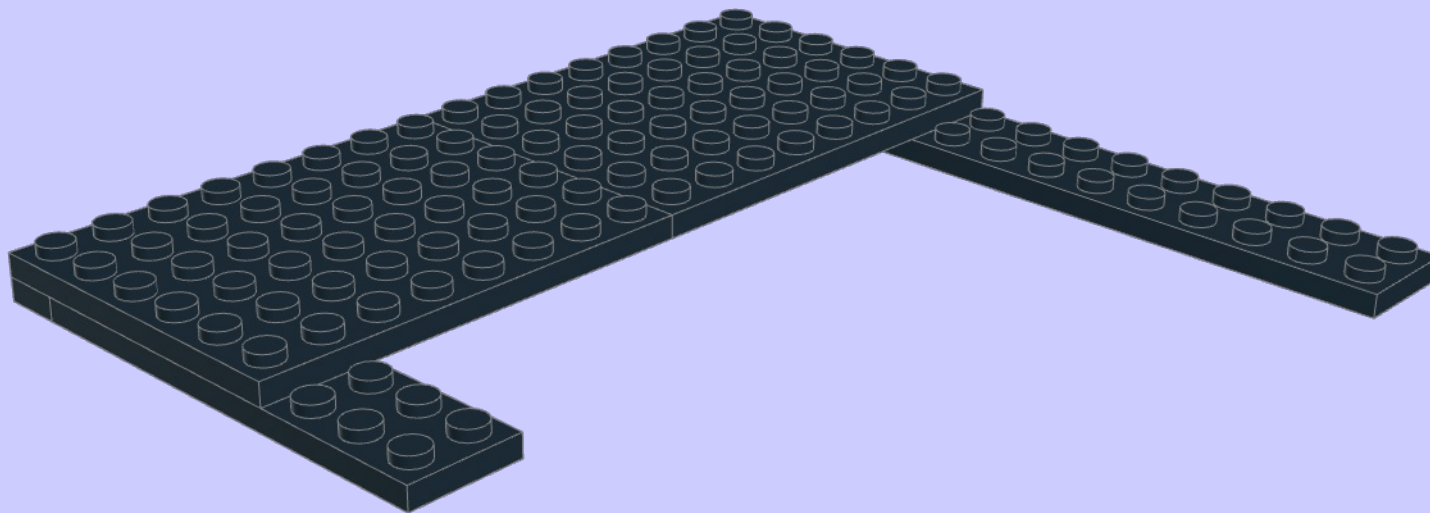

5

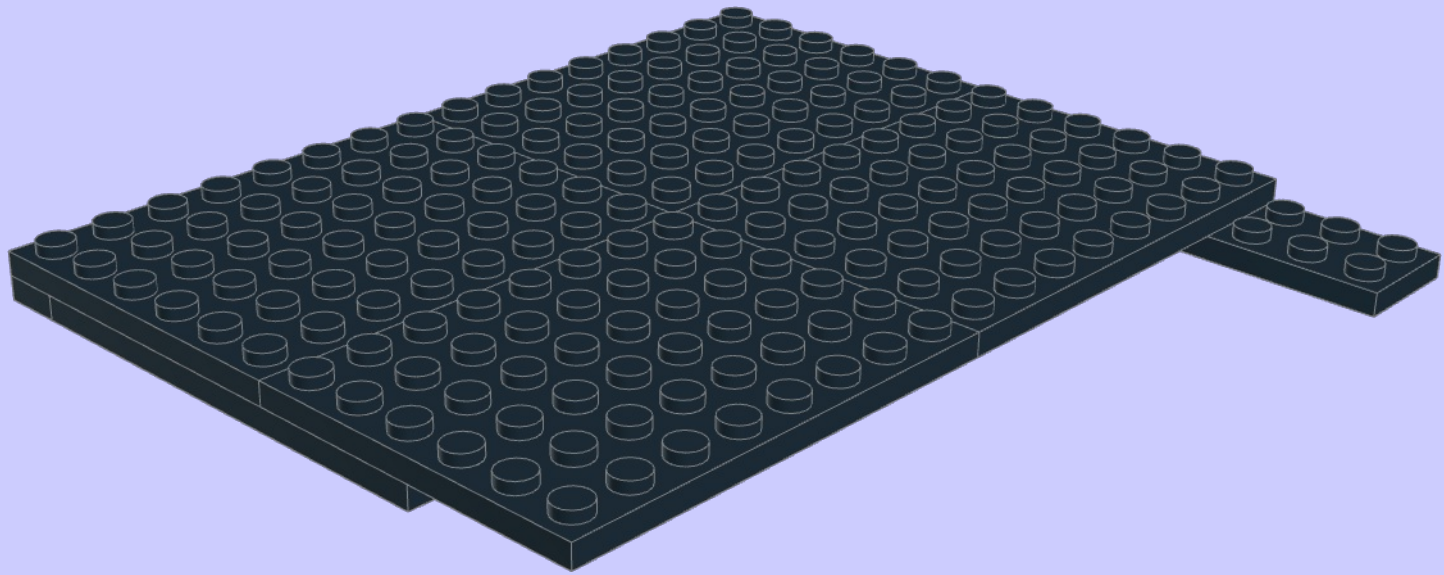
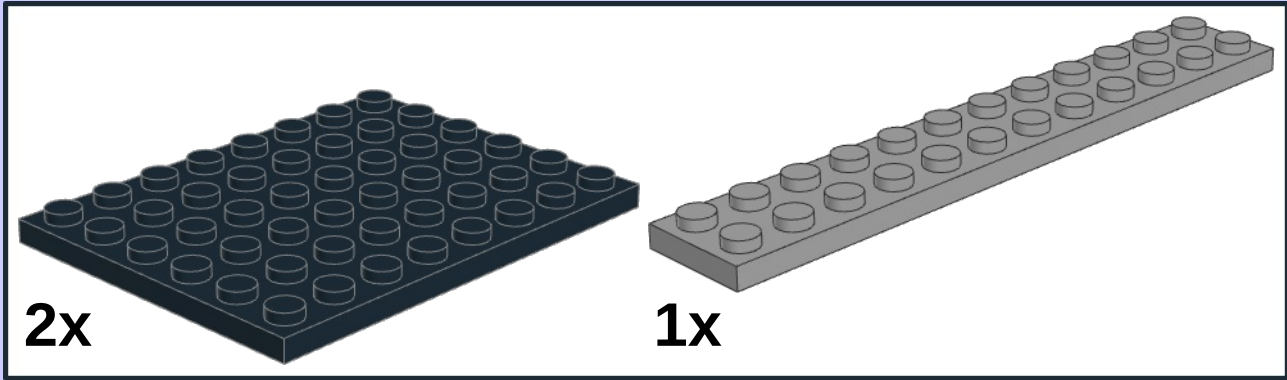

6

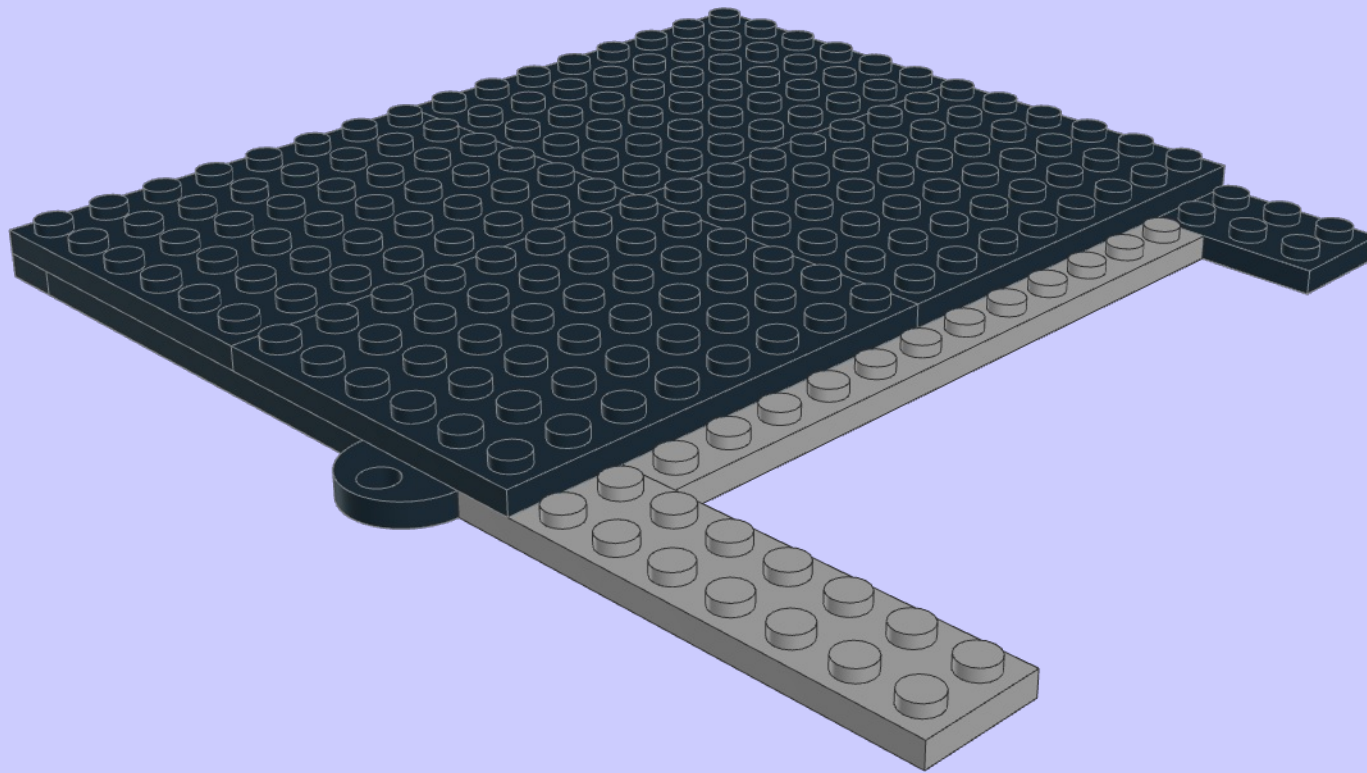
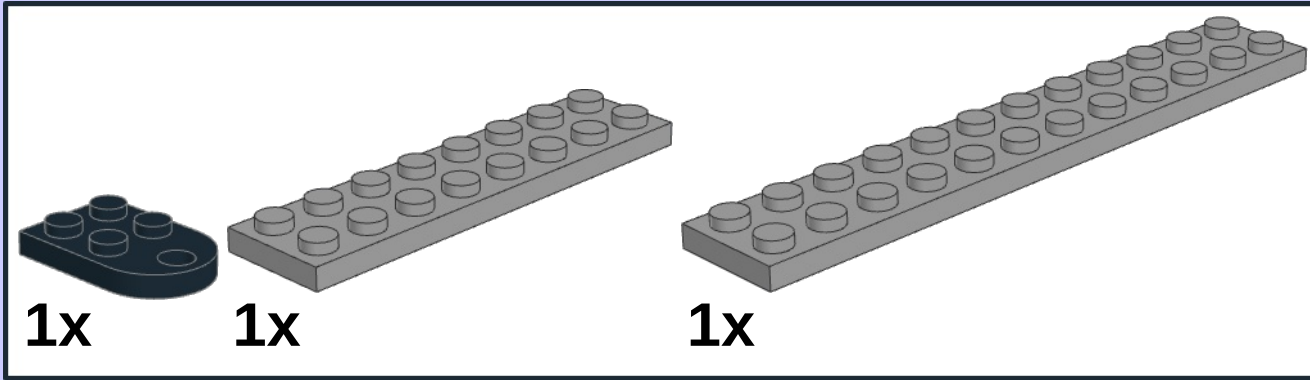

7

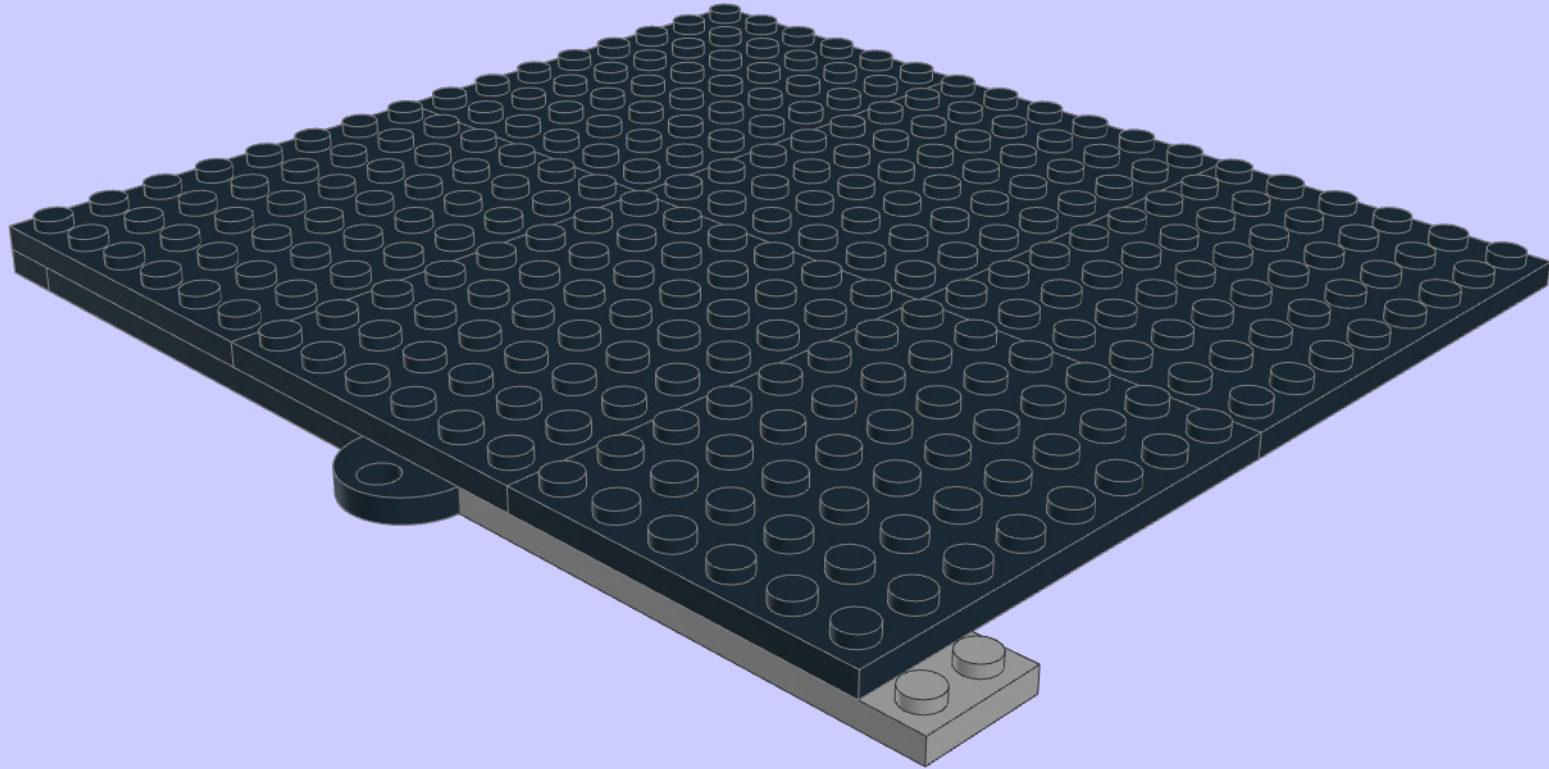
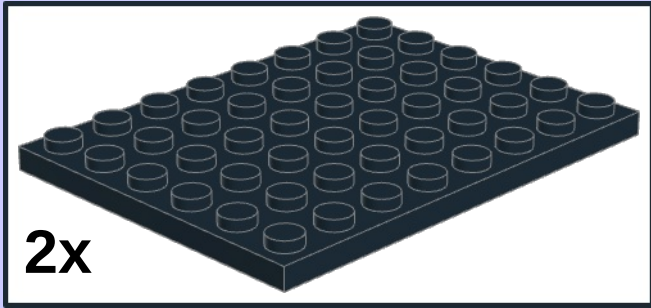

8

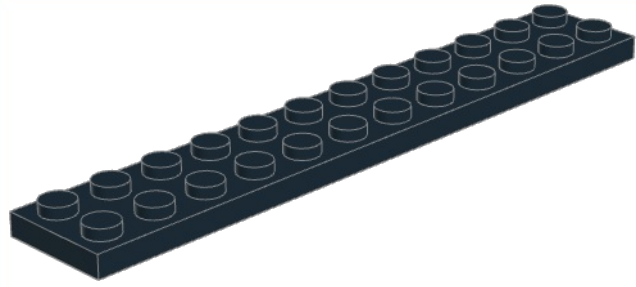

1x

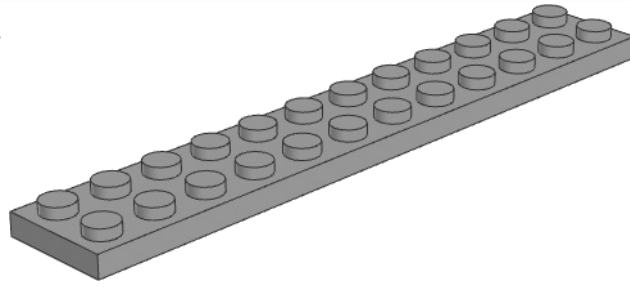

1x

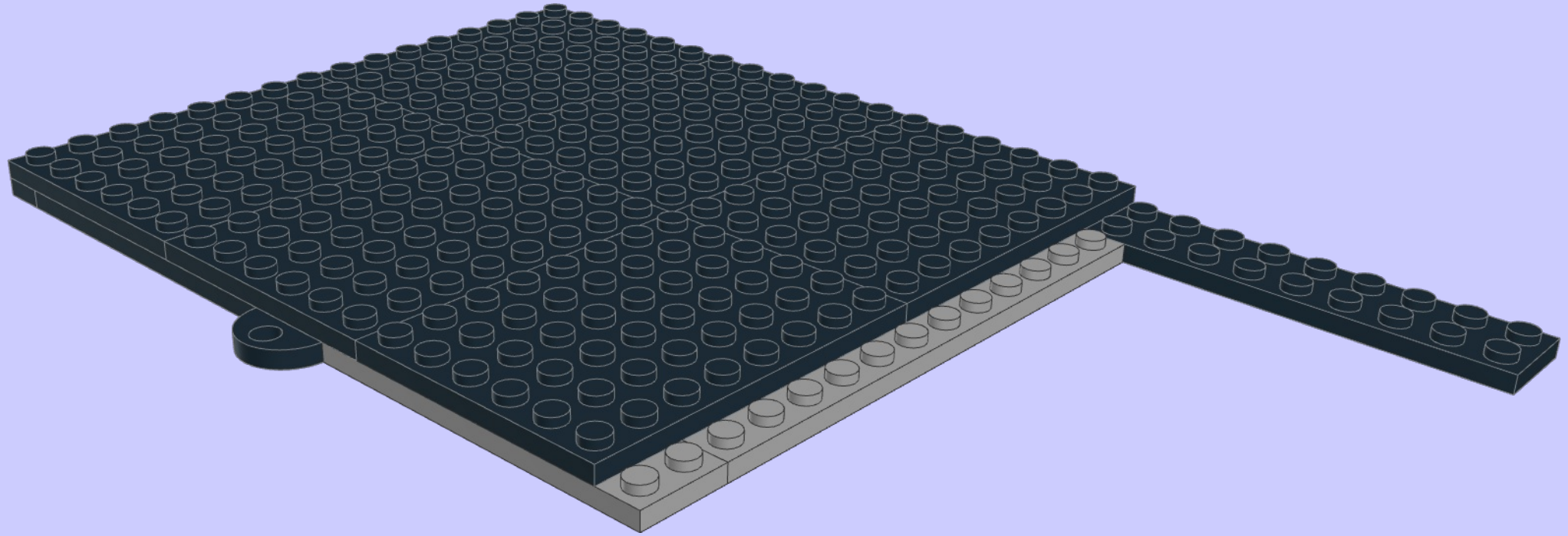

9

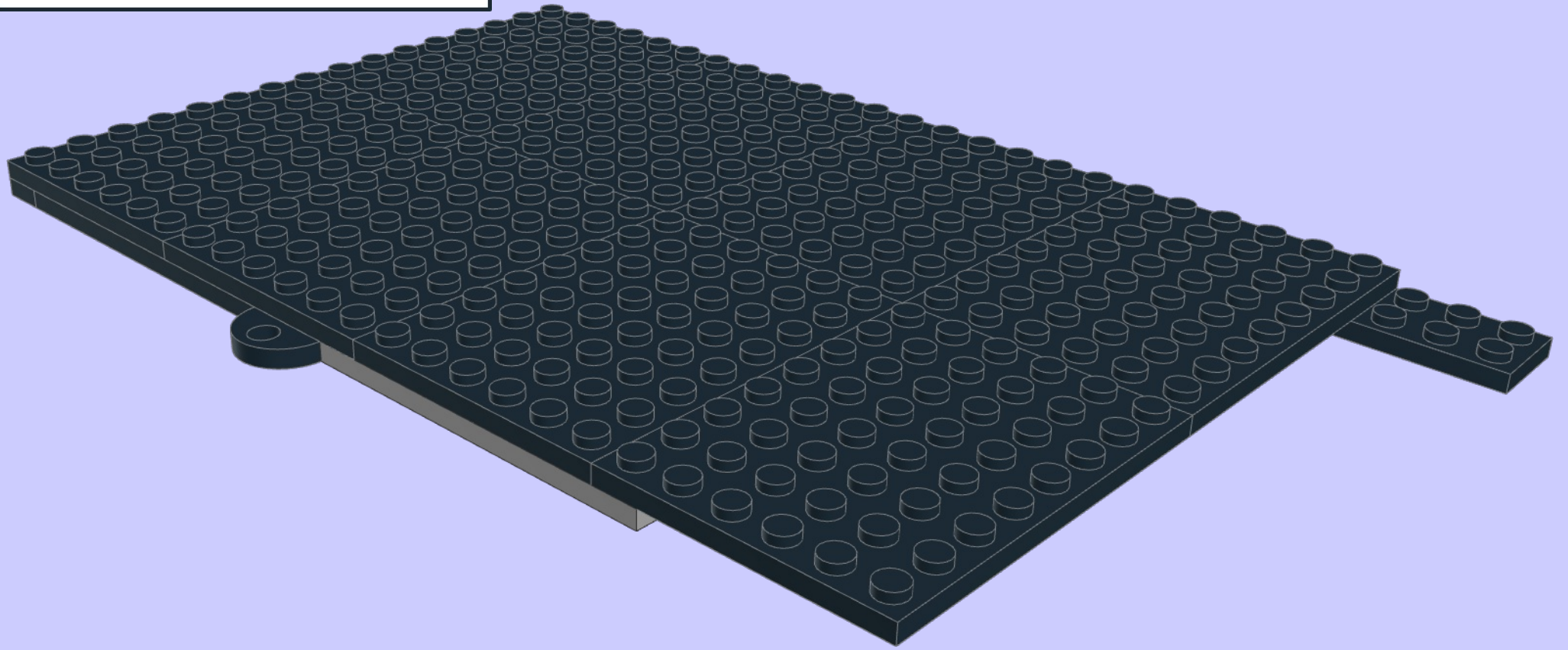
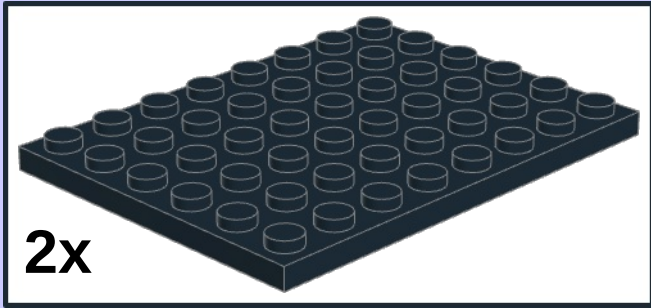

10

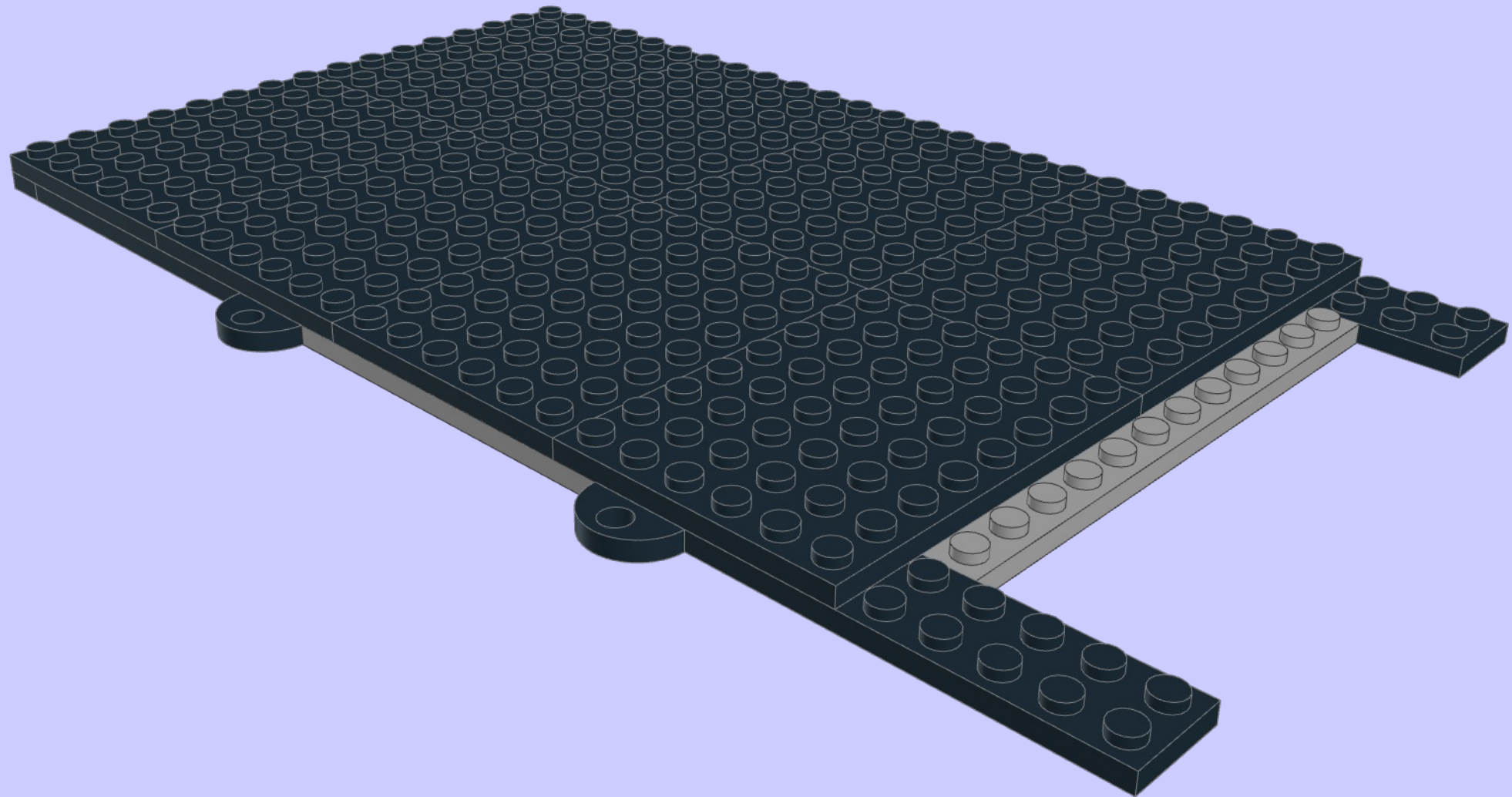
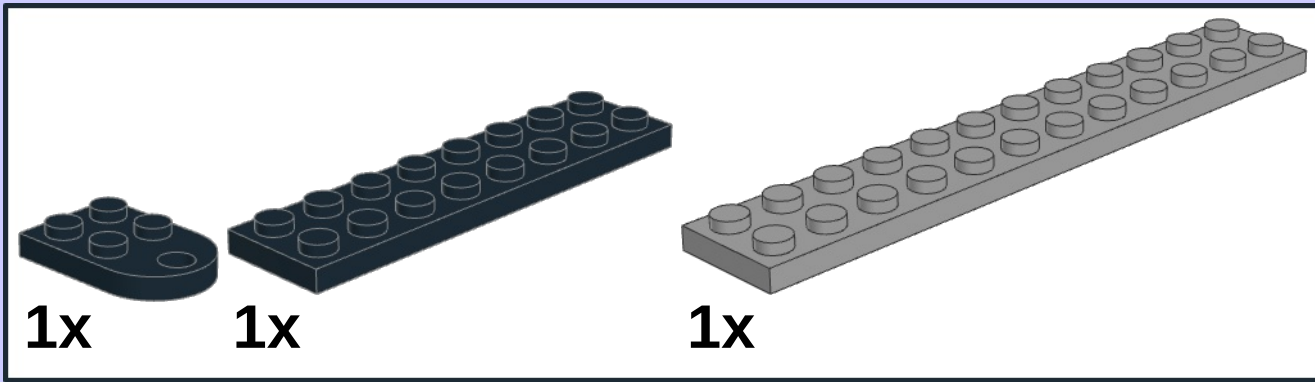

11

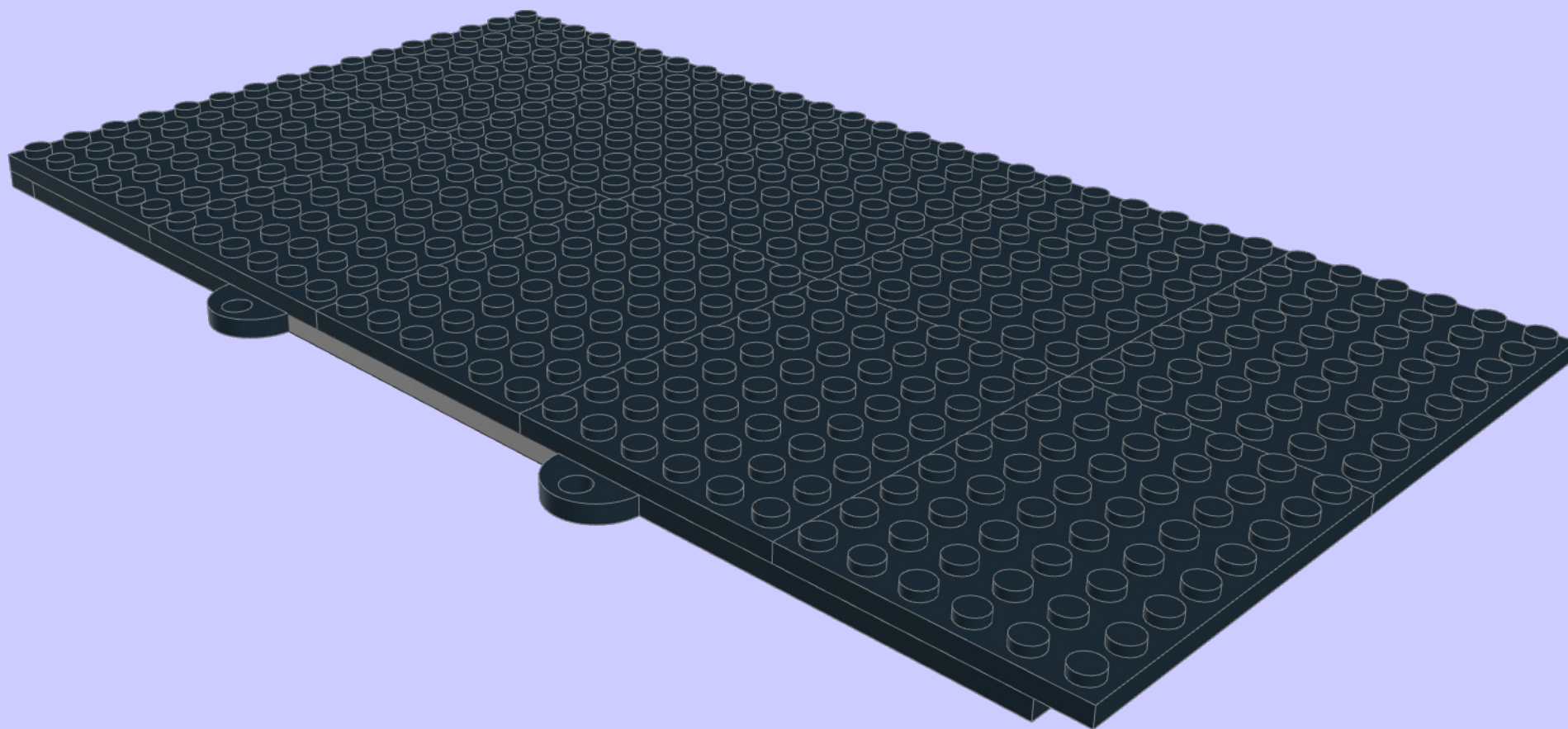
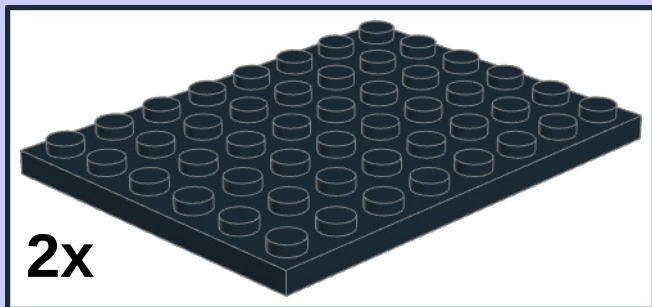

12

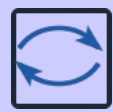
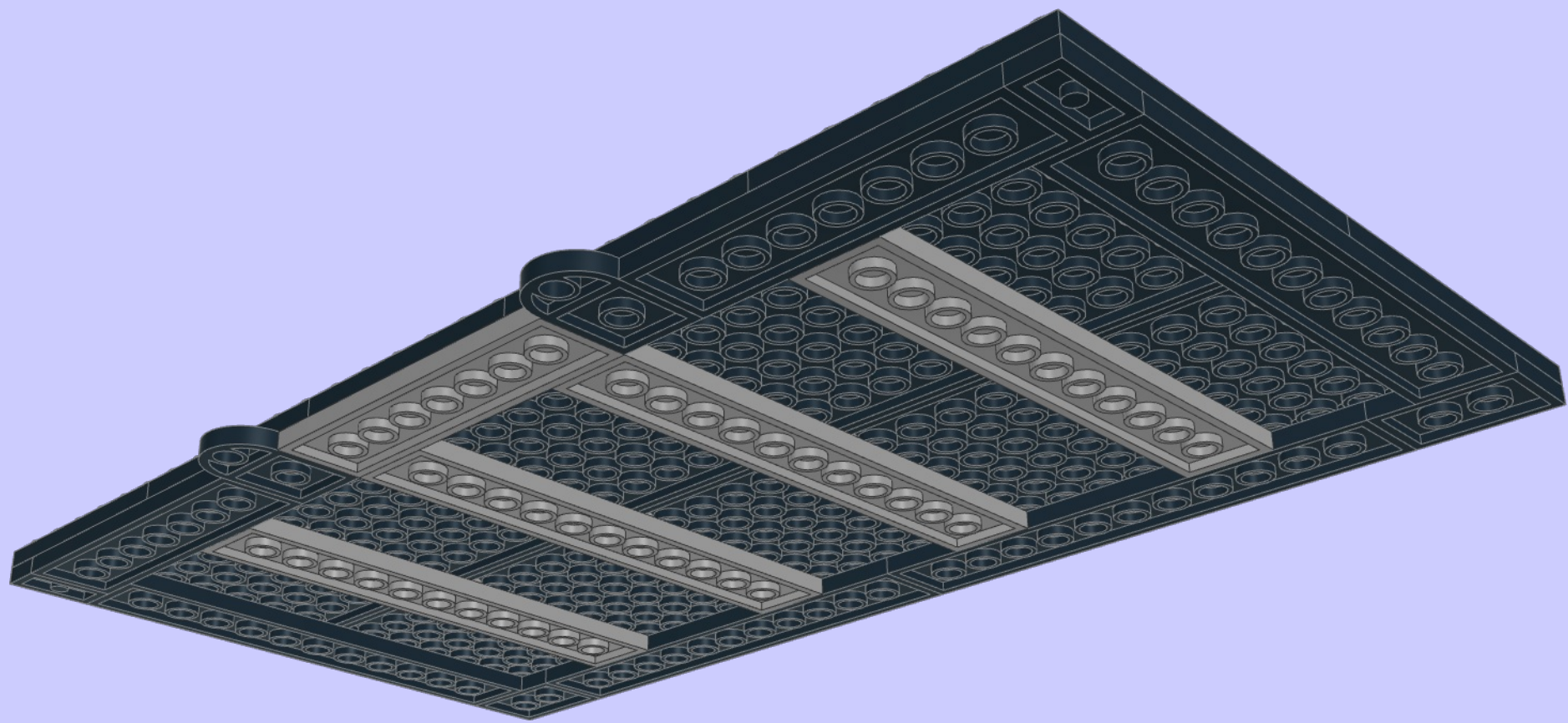
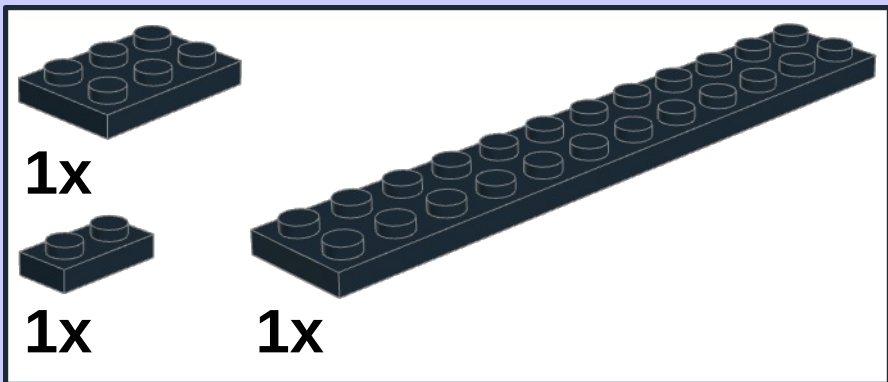

13

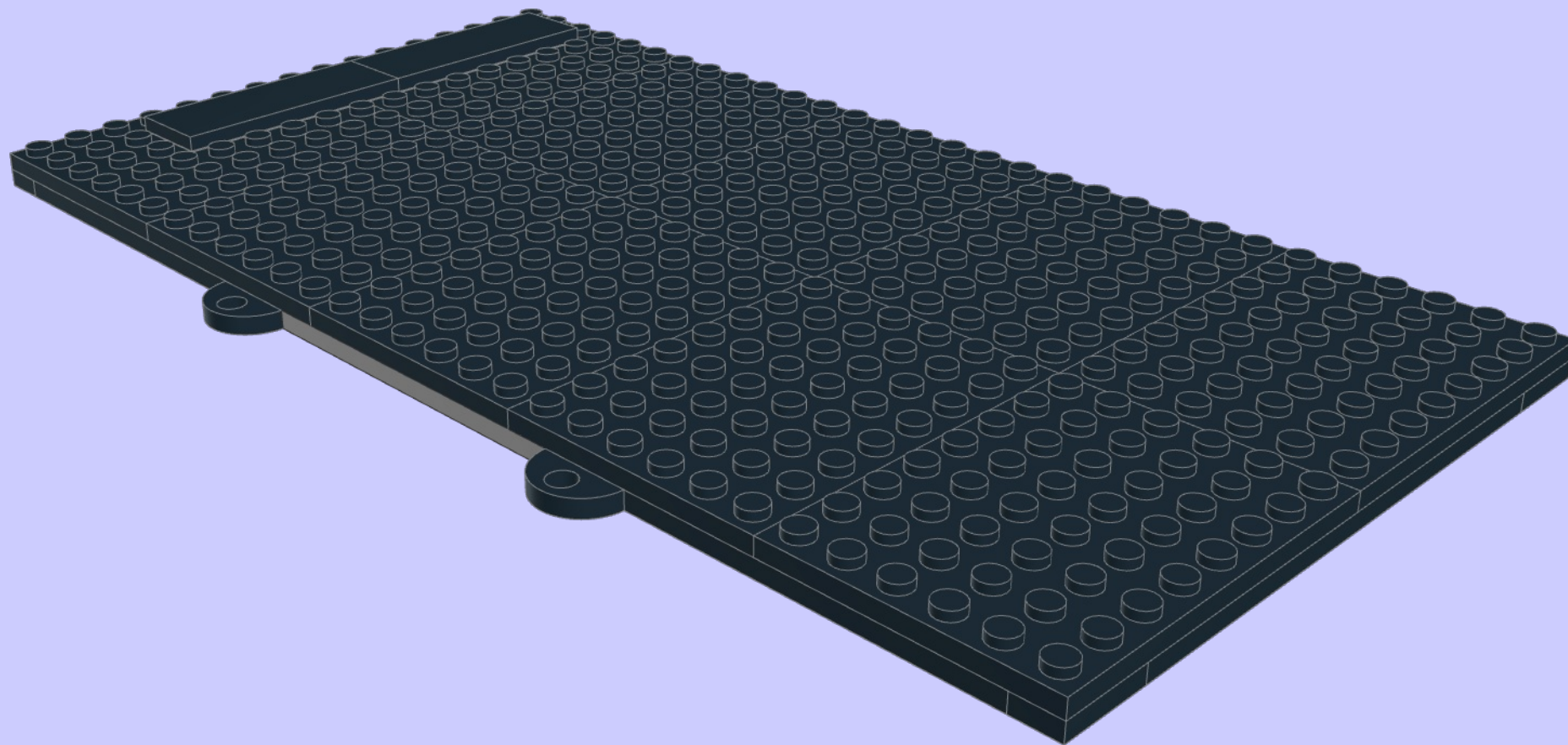
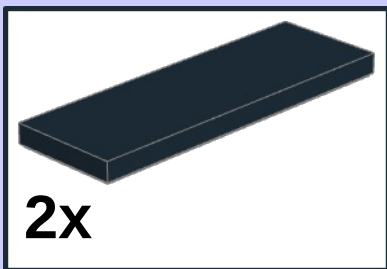

14

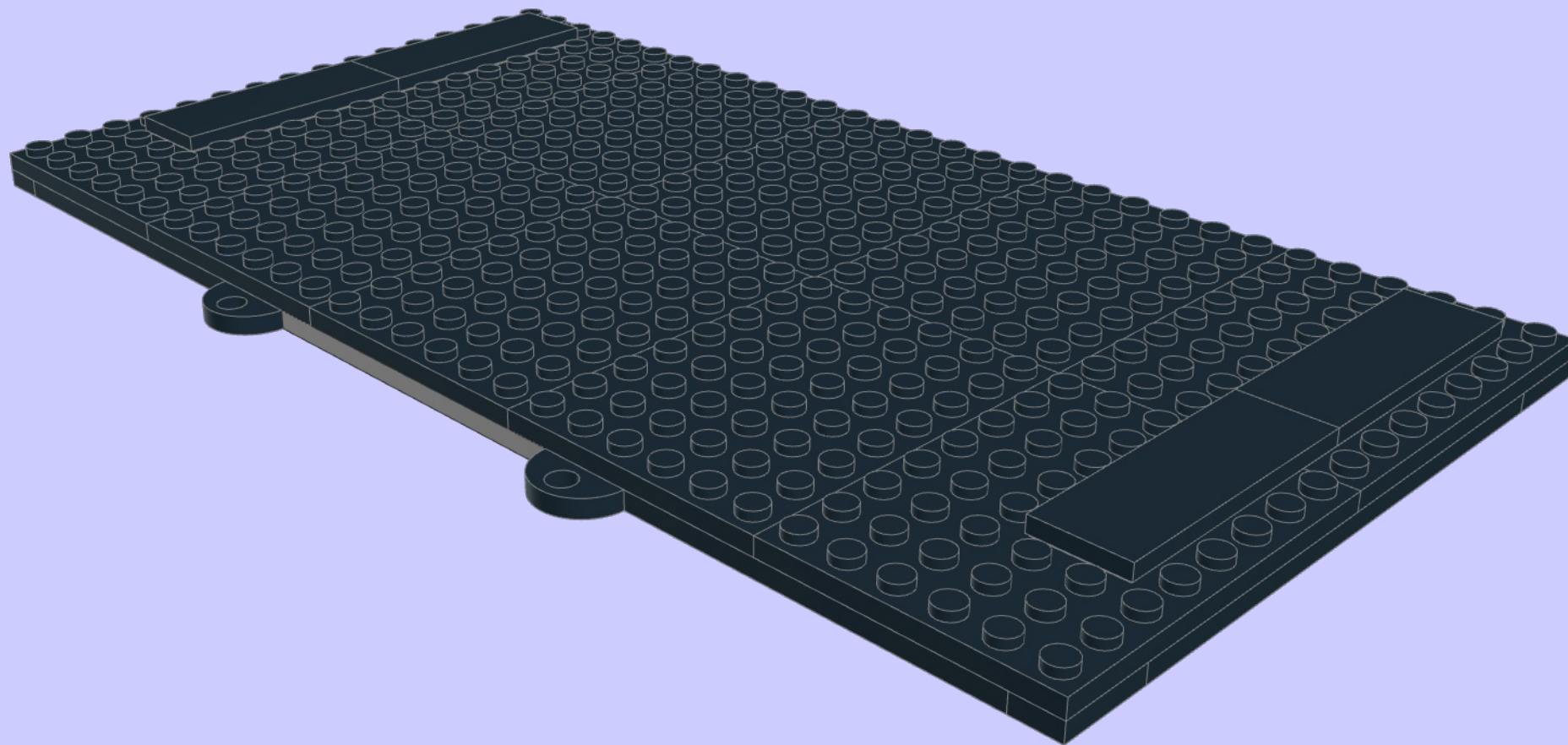
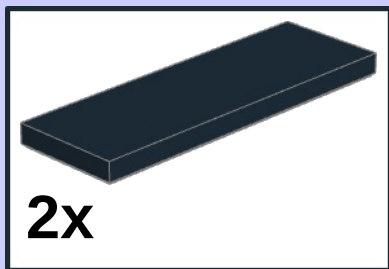

15

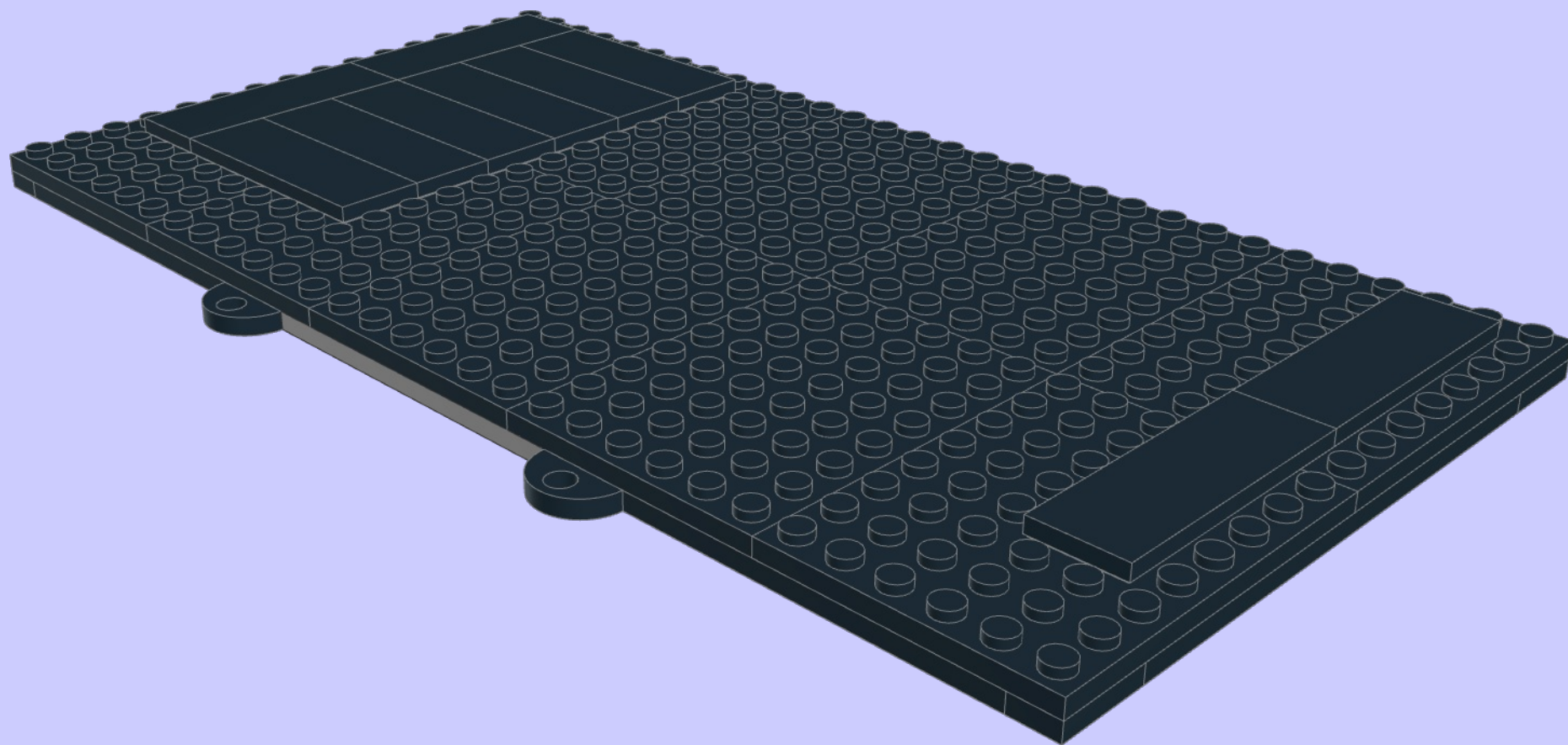
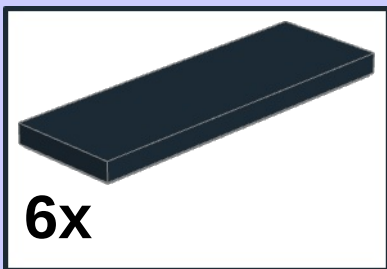

16

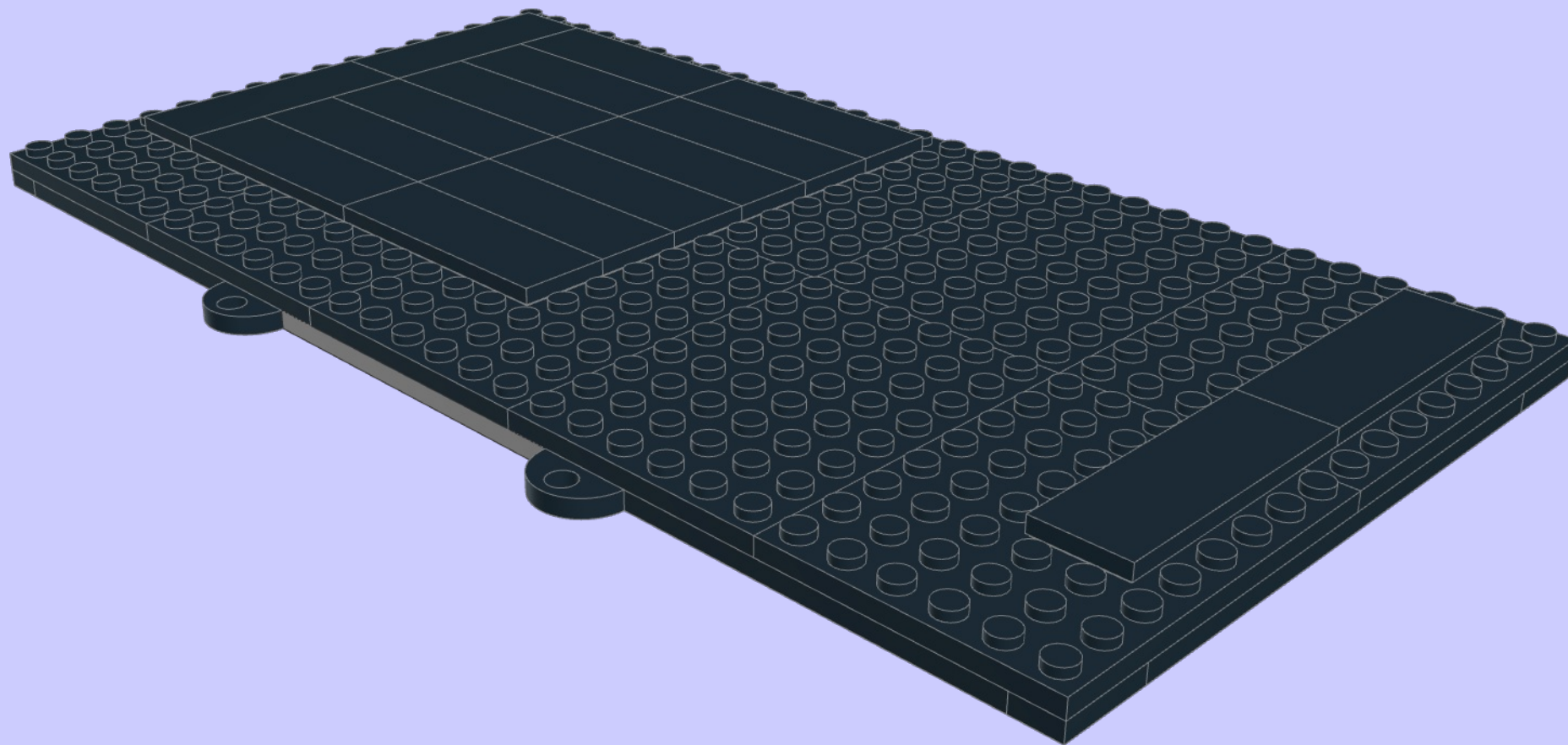
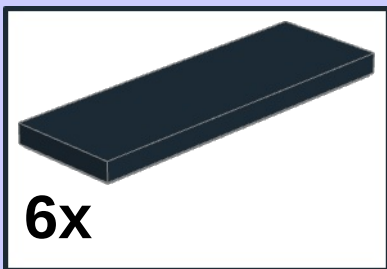

17

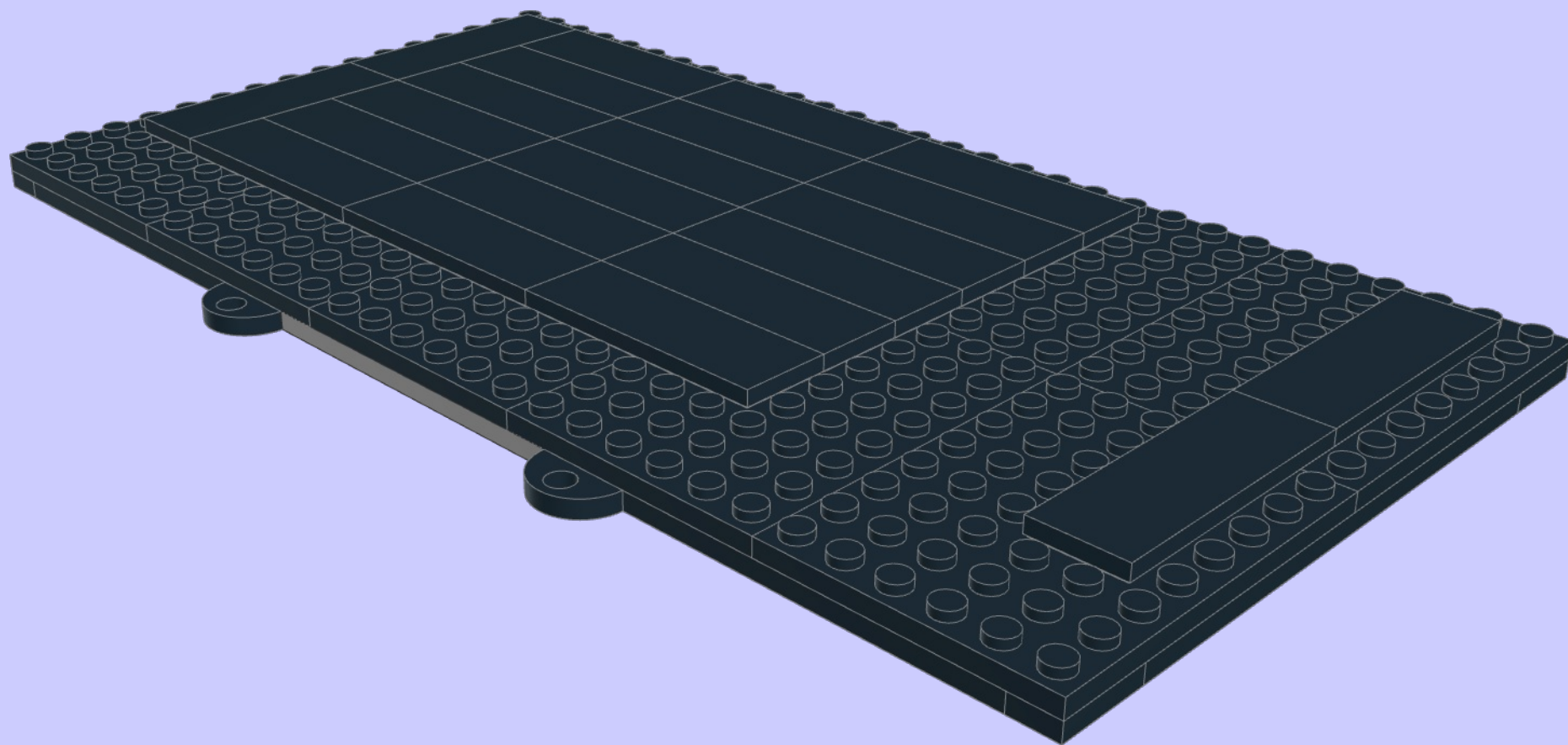
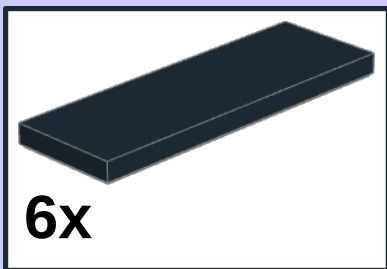

18

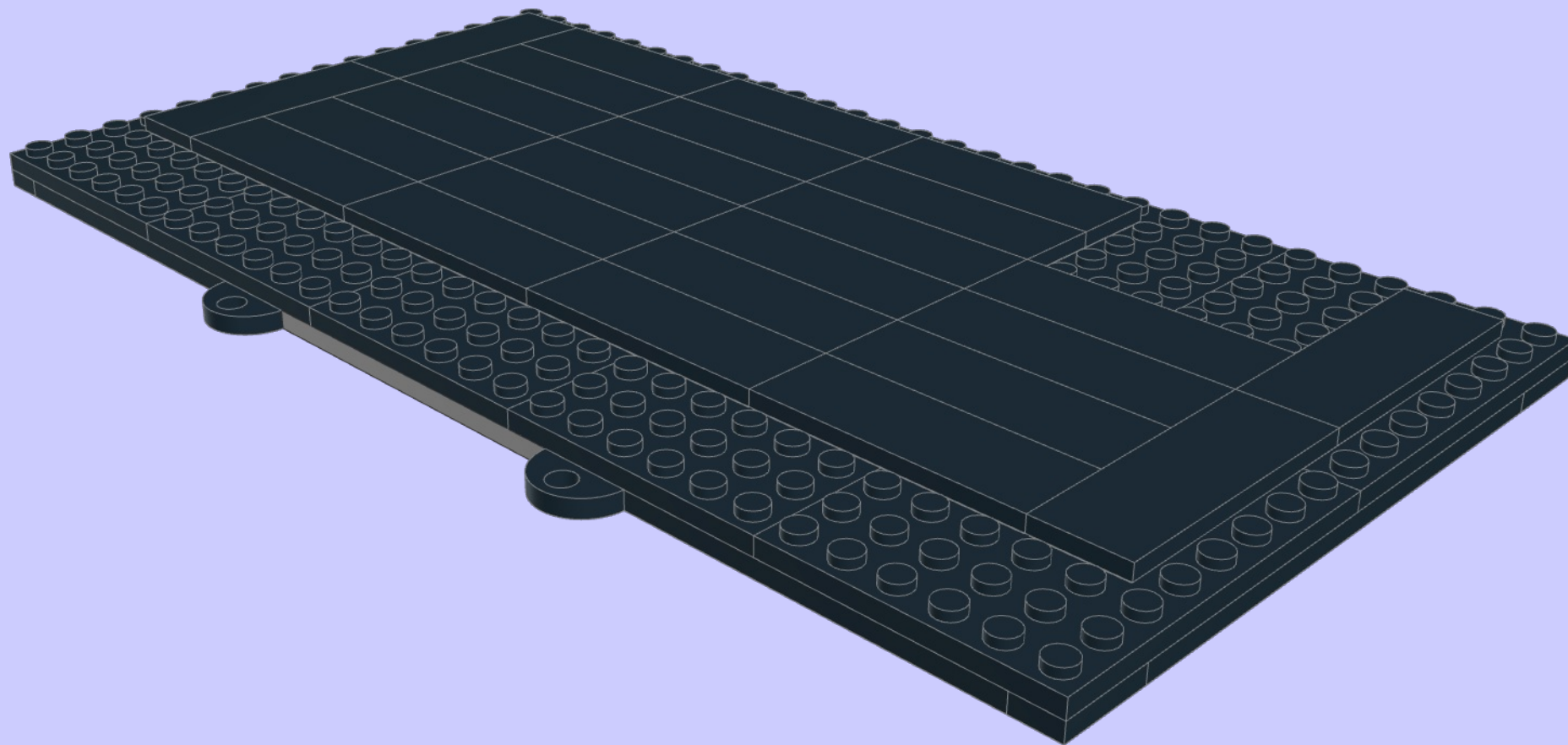
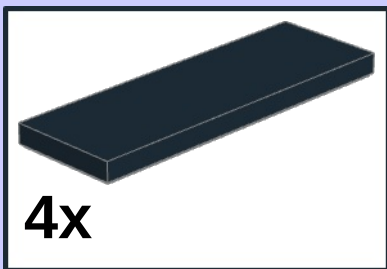

19

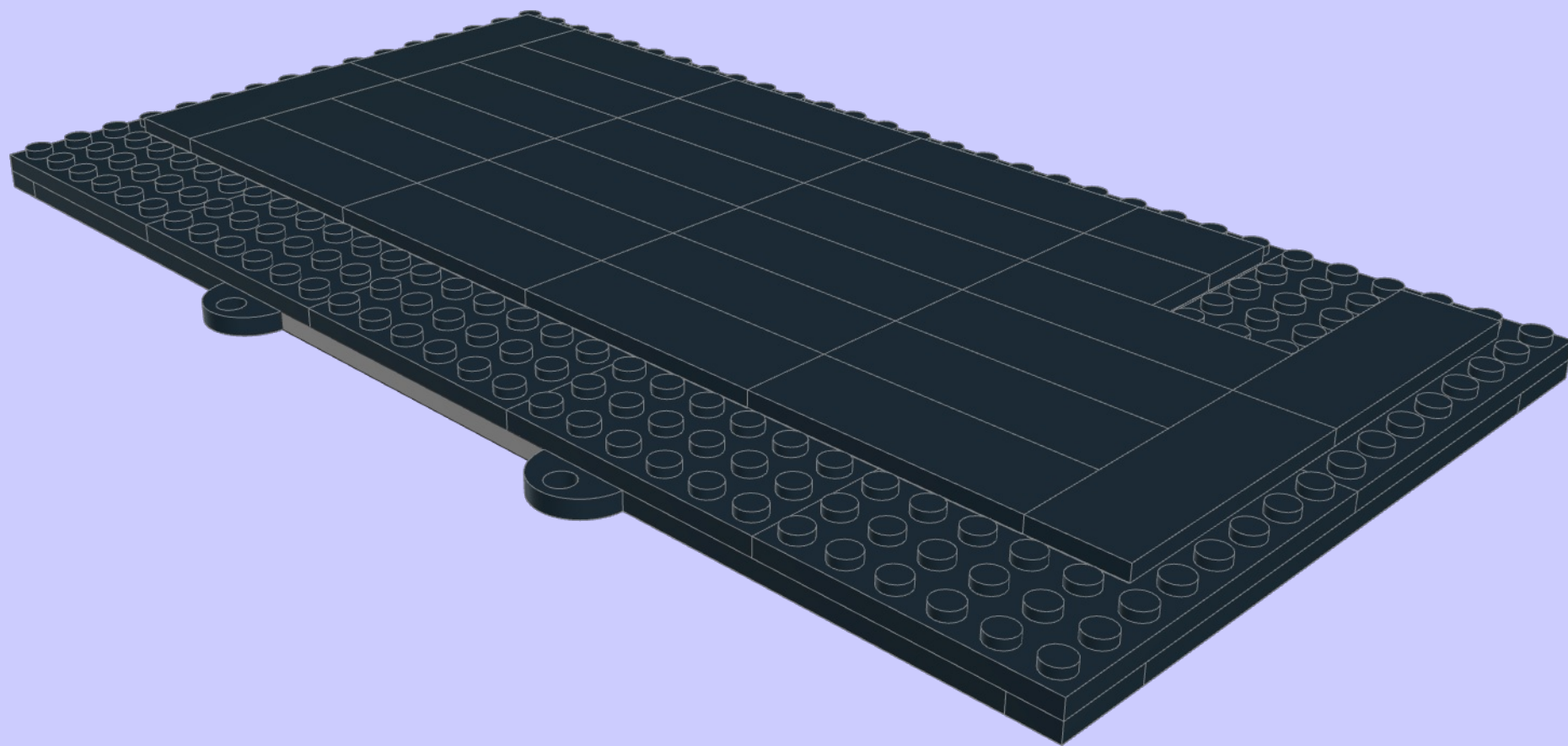
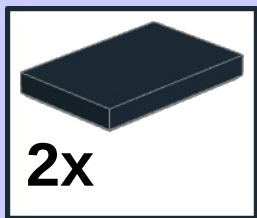

20

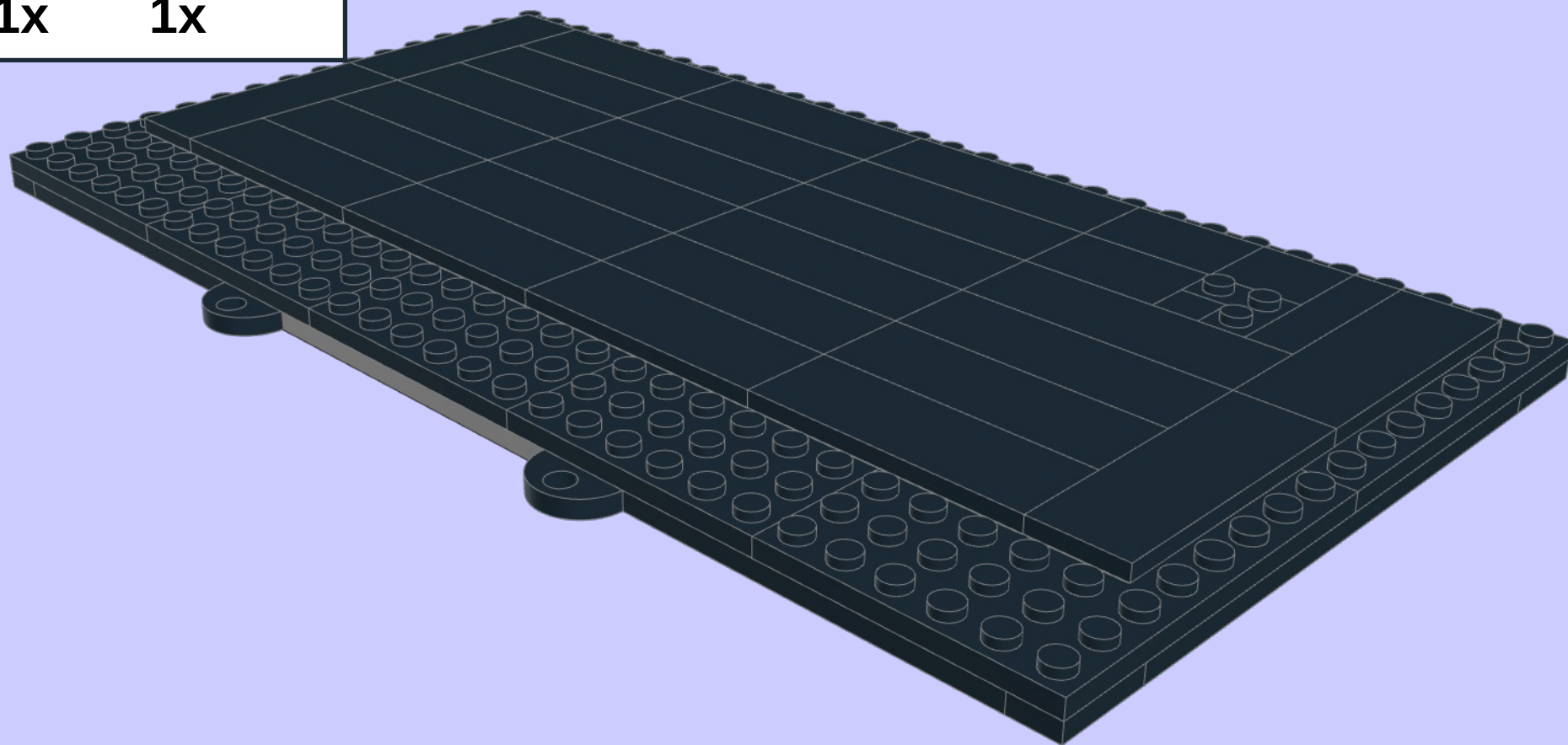
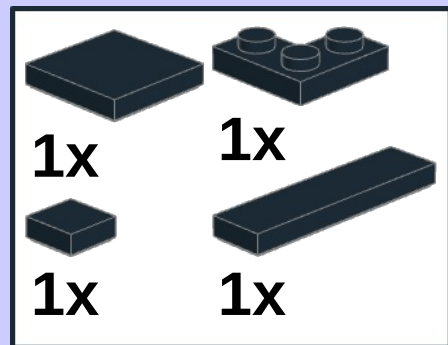

21

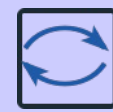
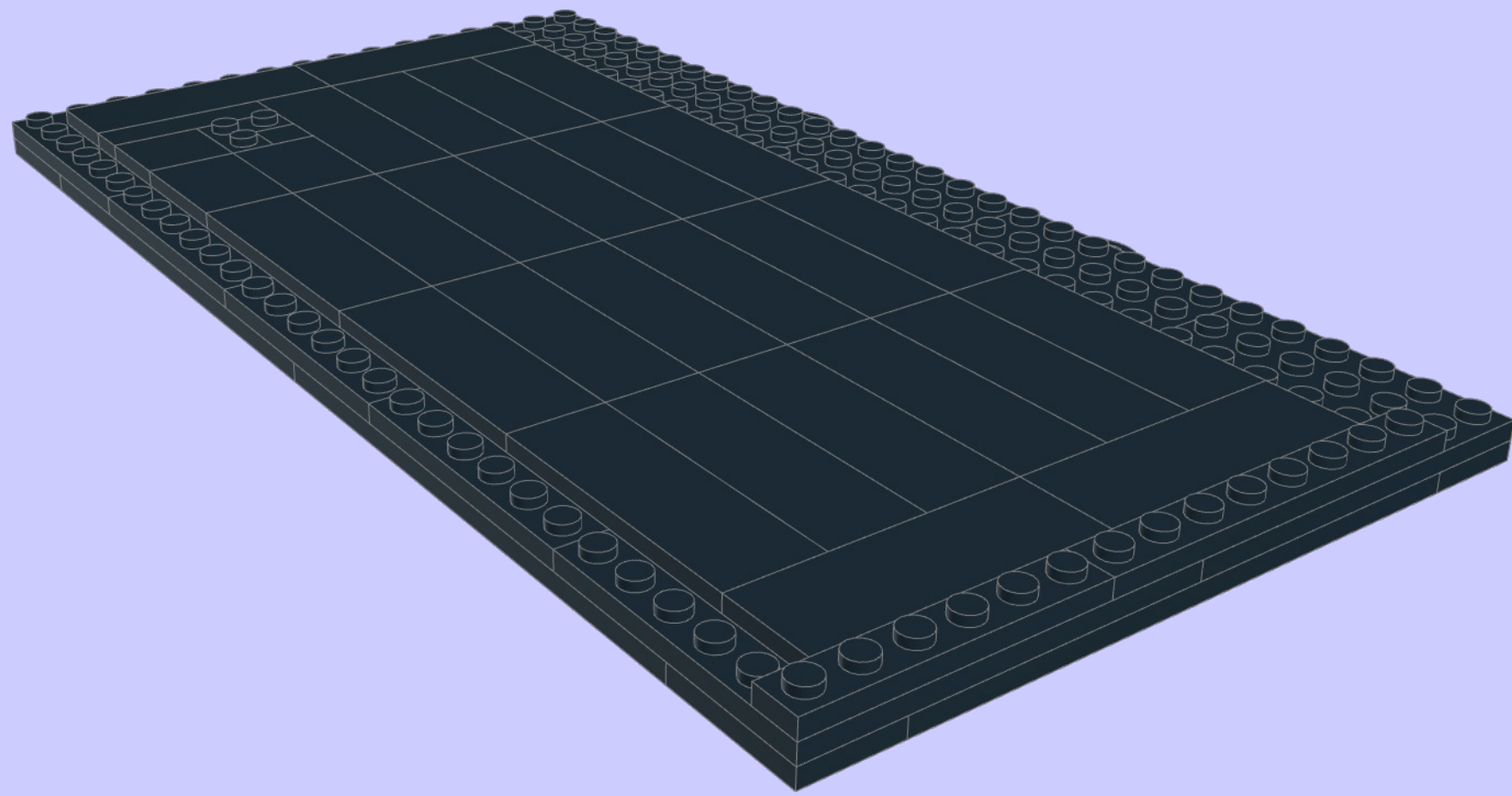
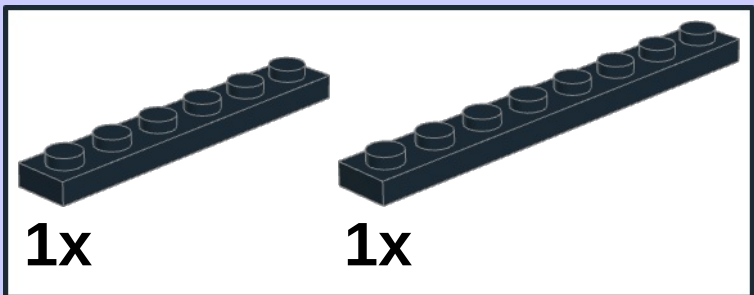

22

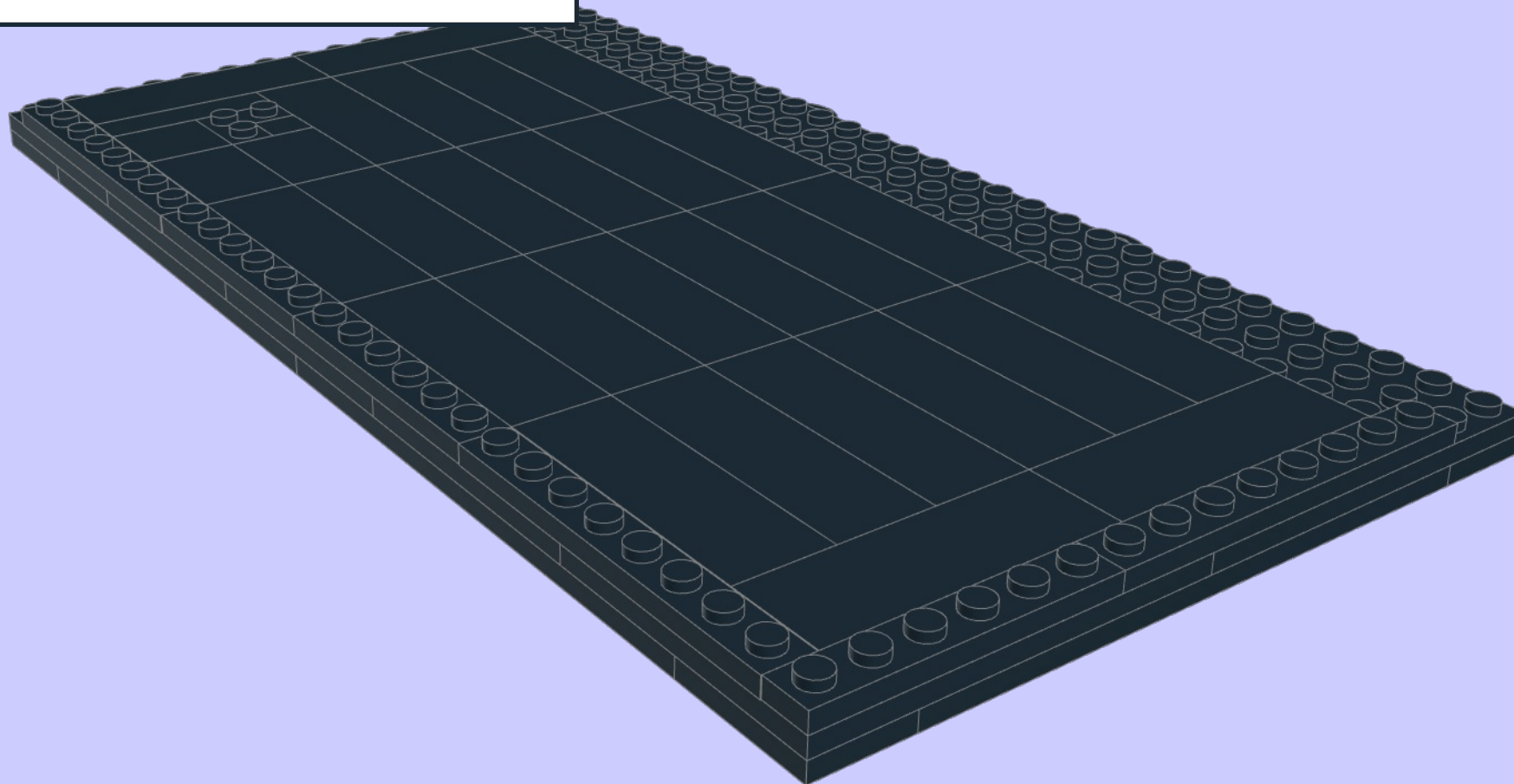
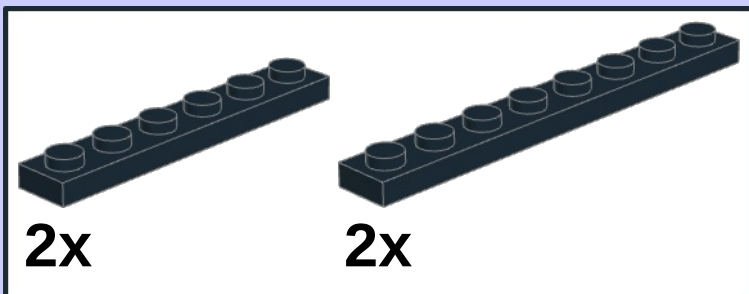

23

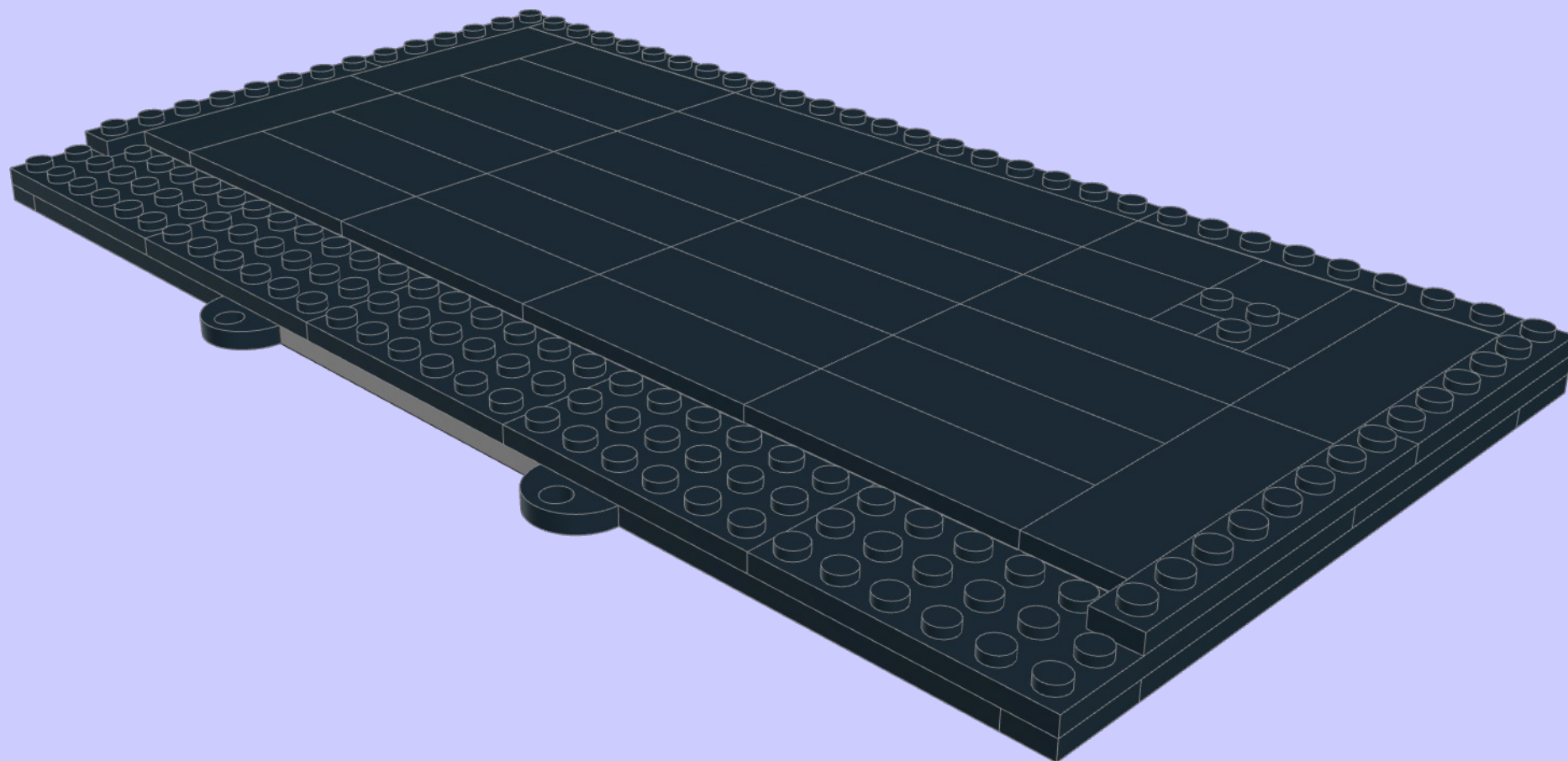
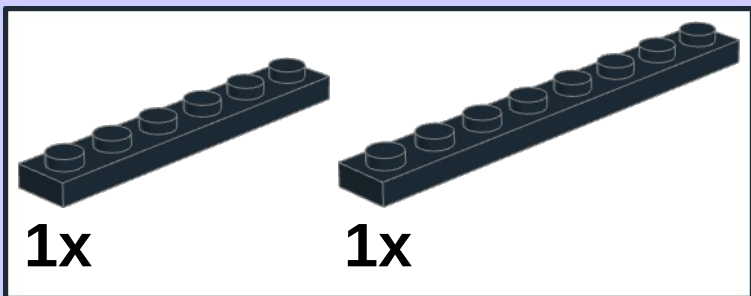

24

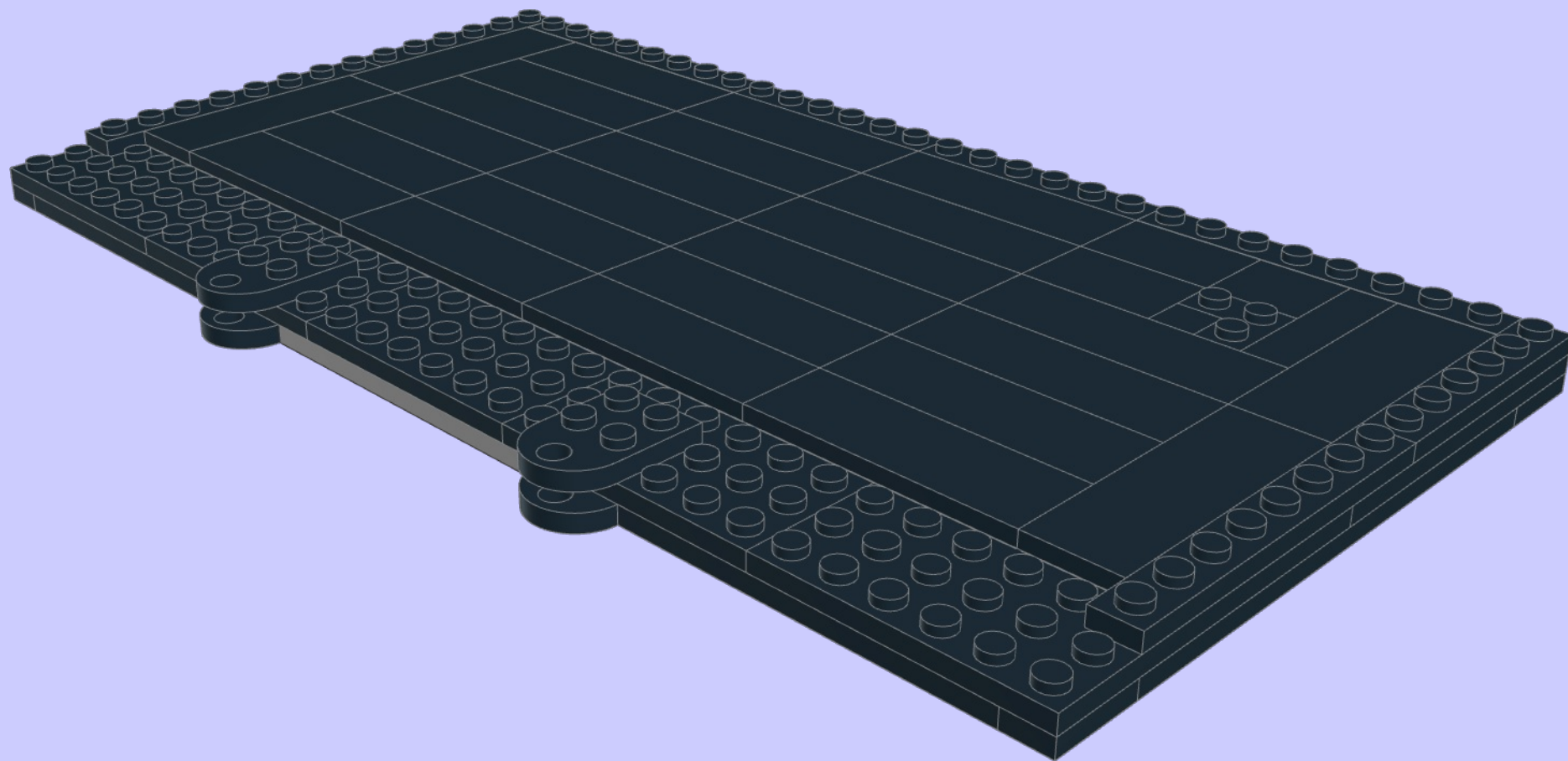
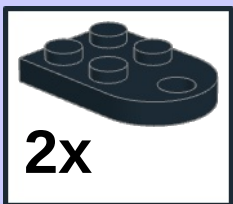

25

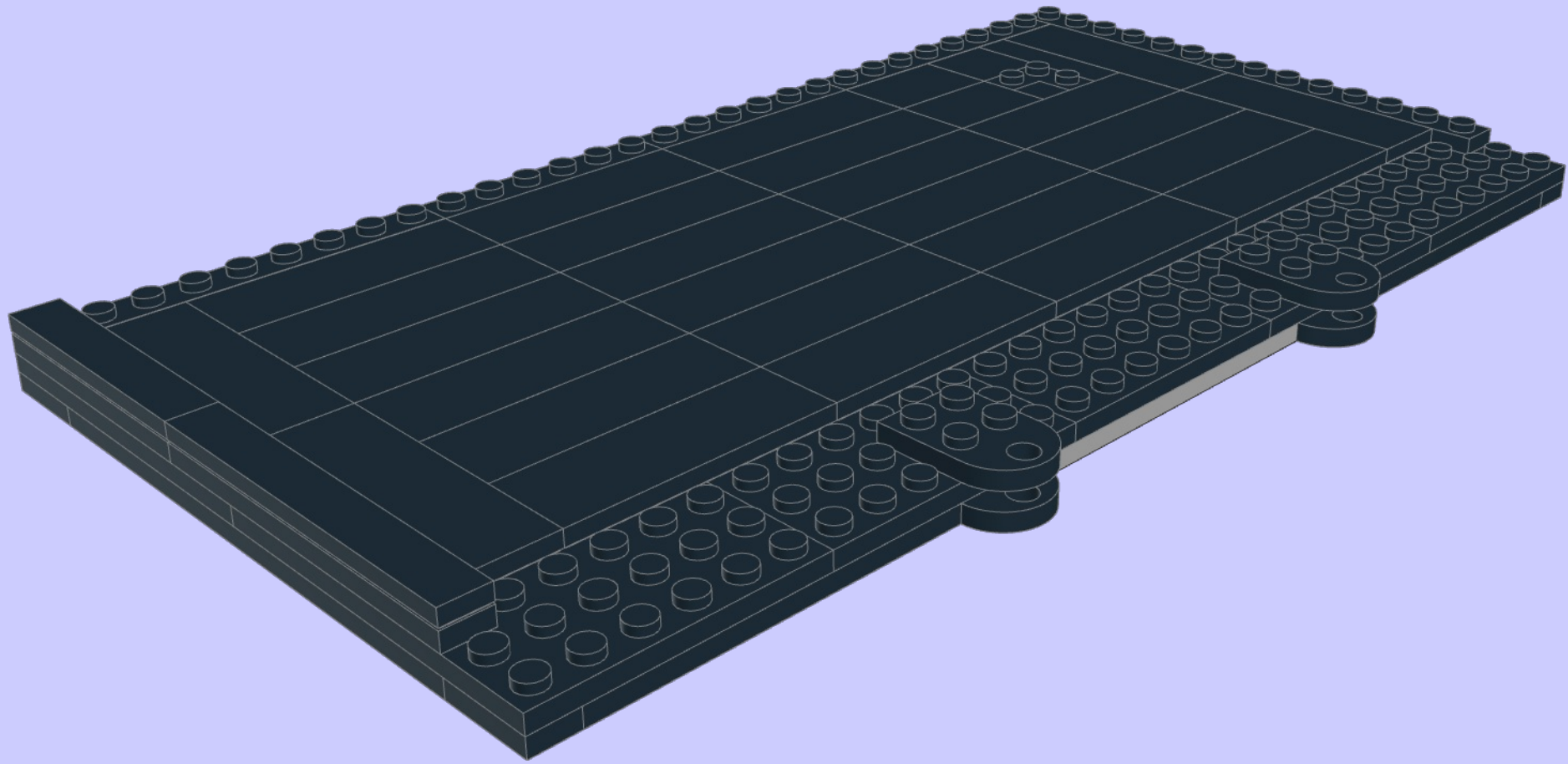
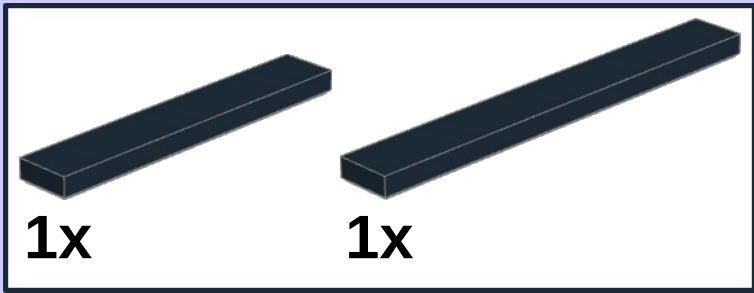

26

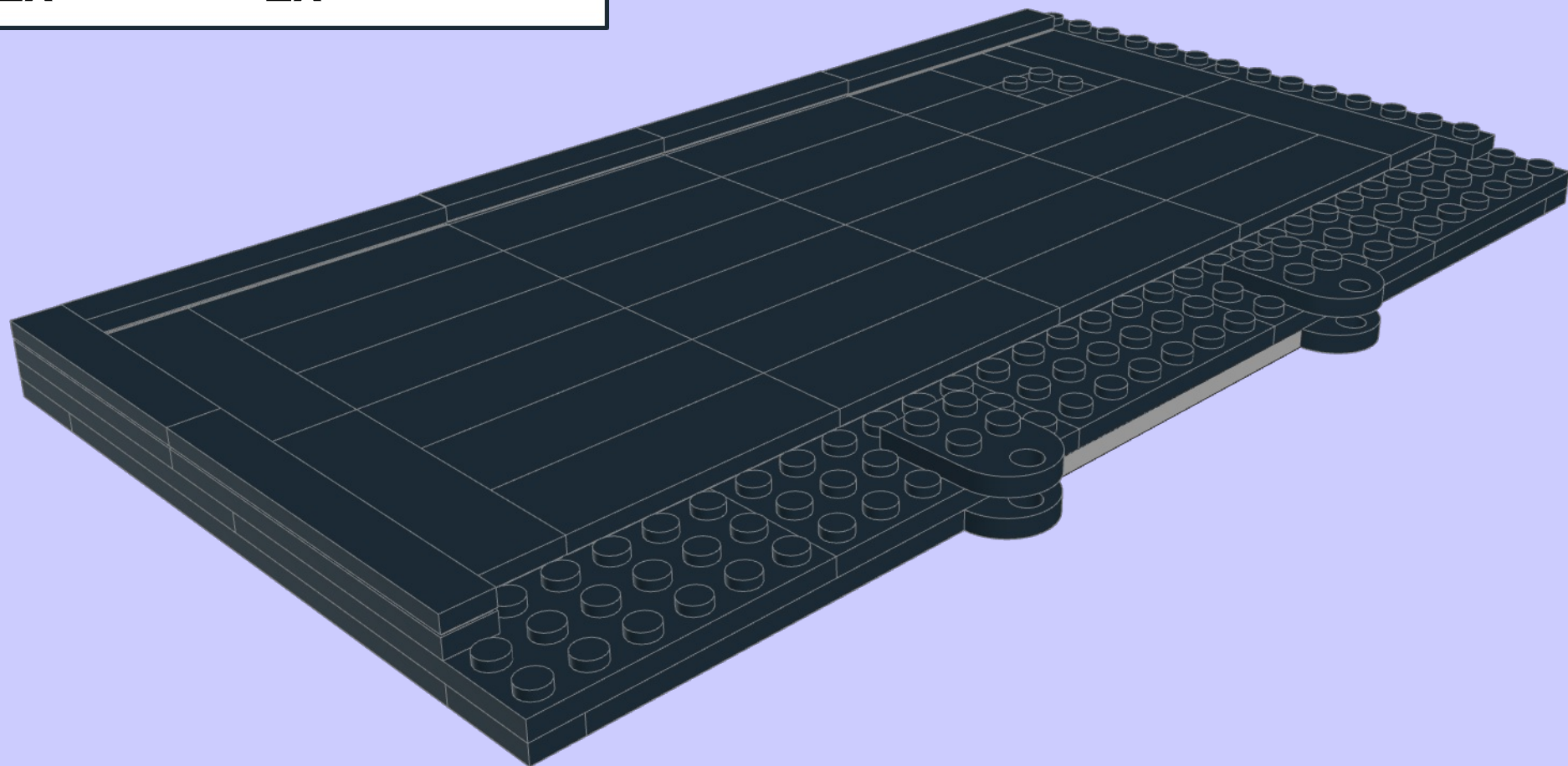
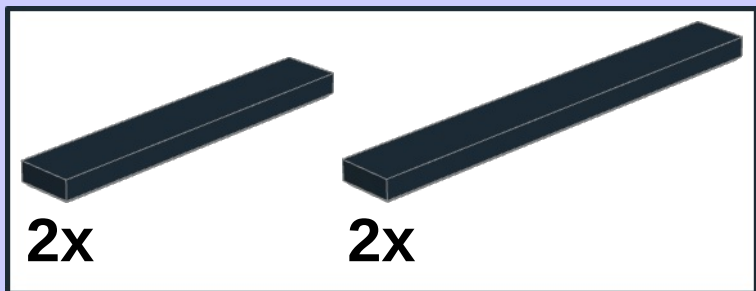

27

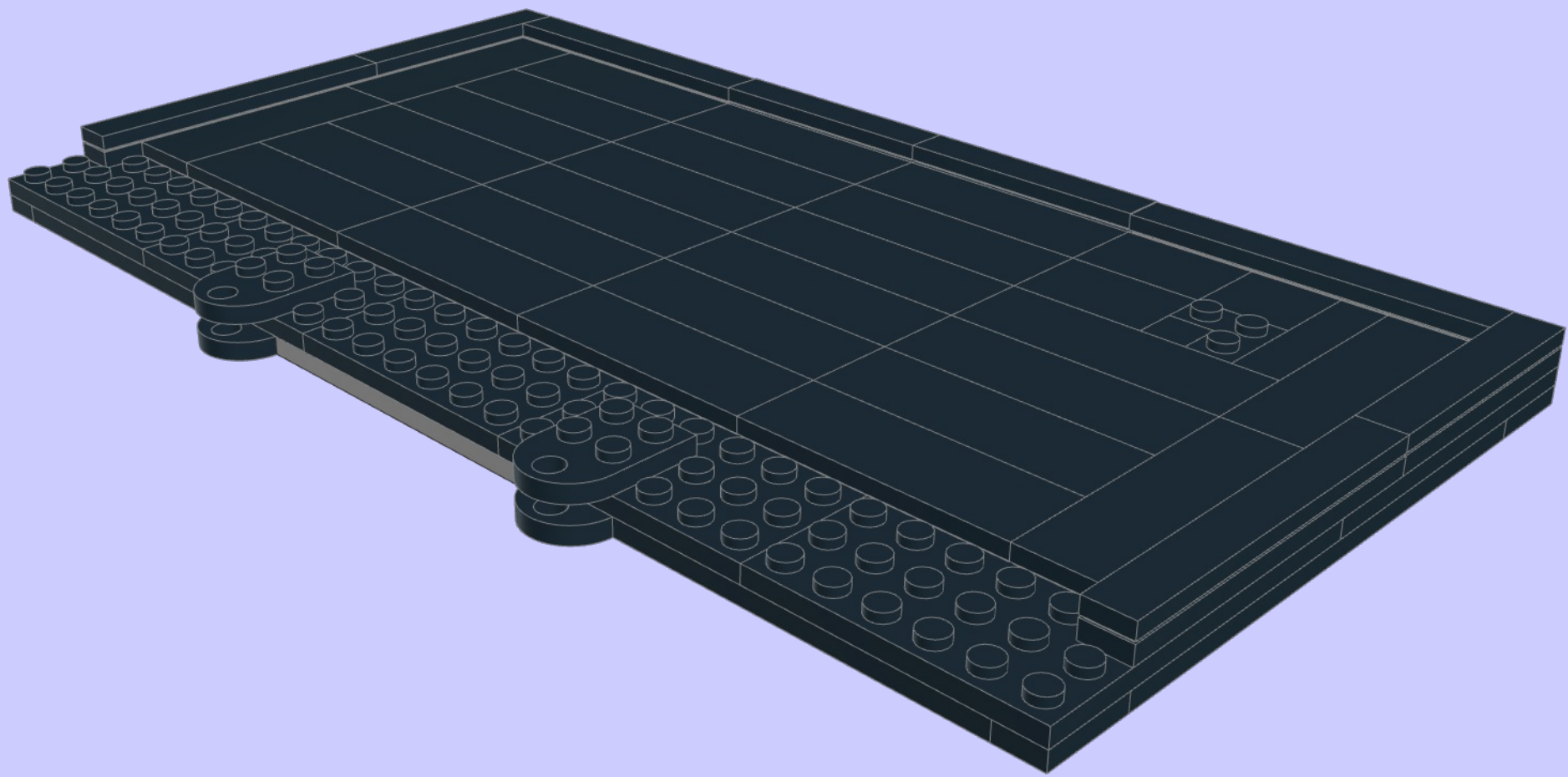
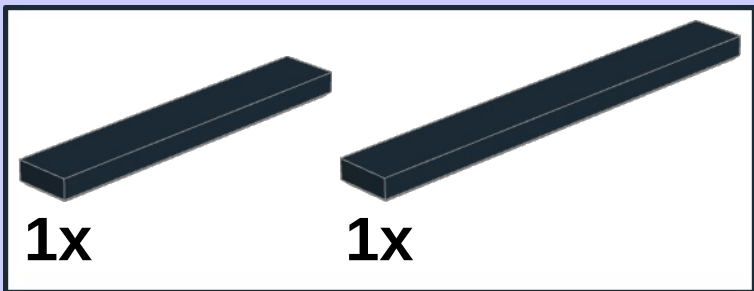

28

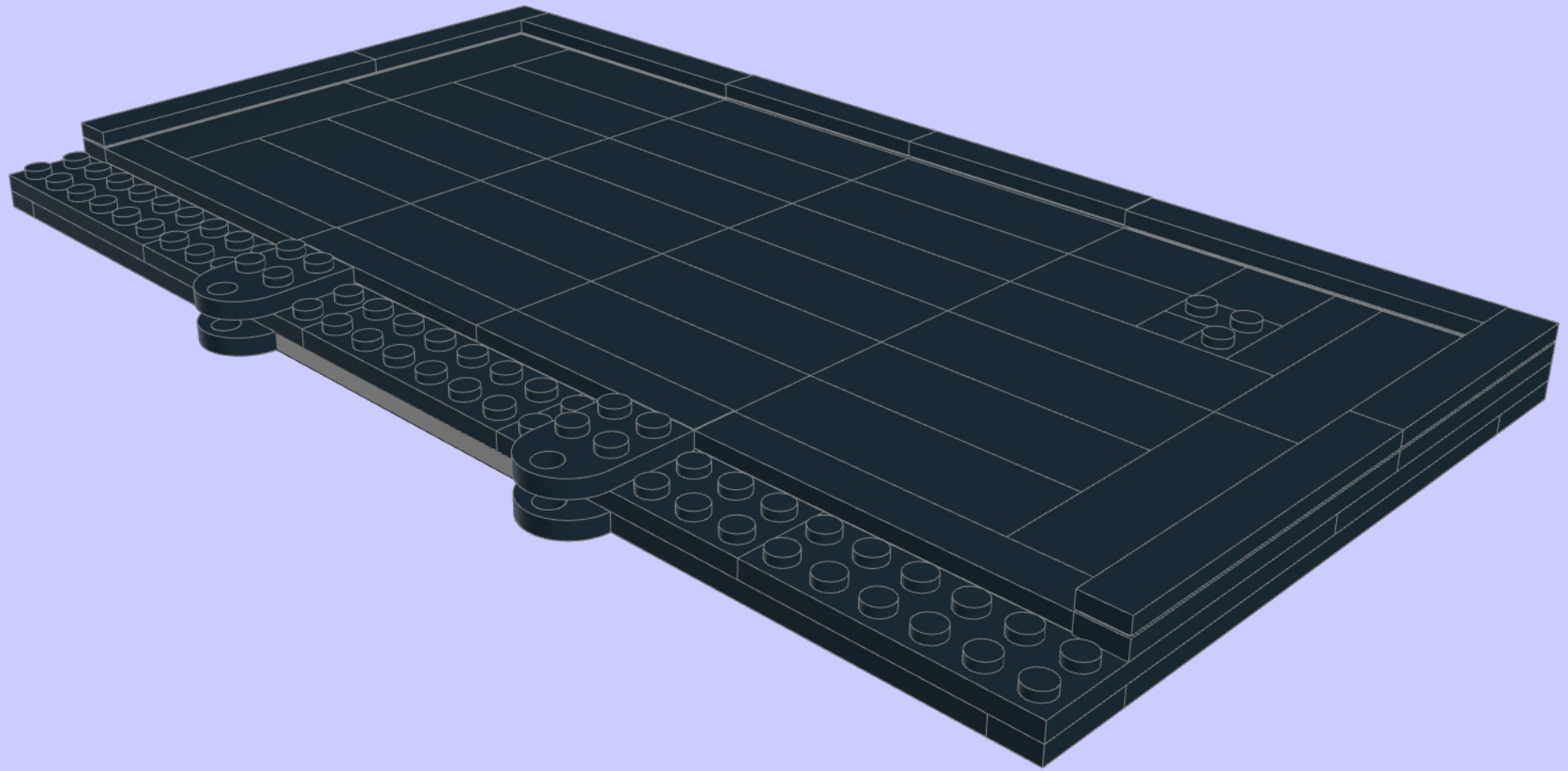
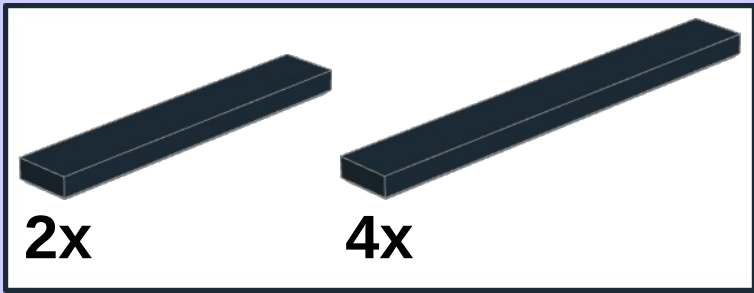

29

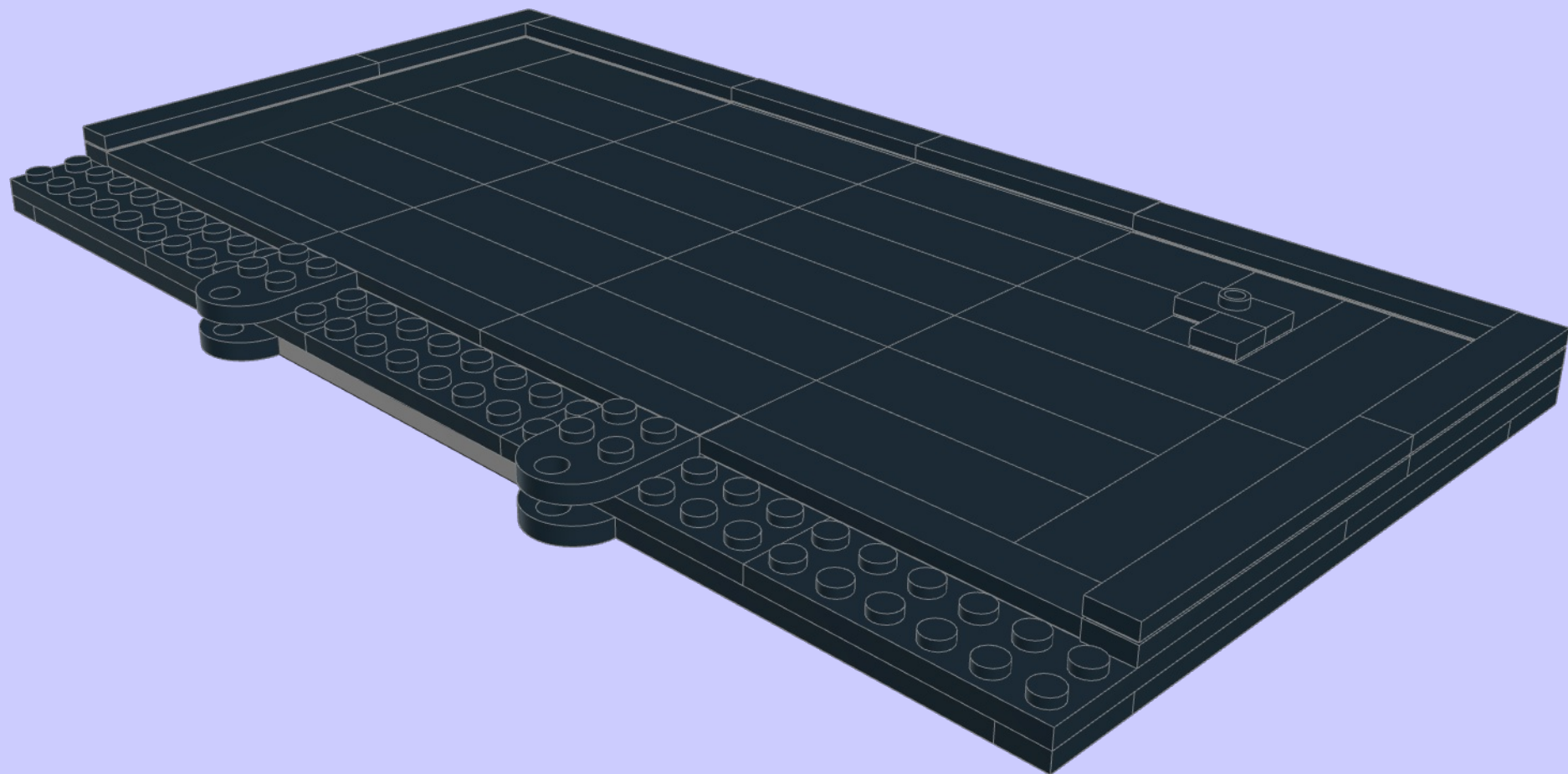
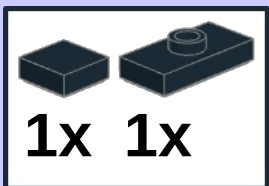

30

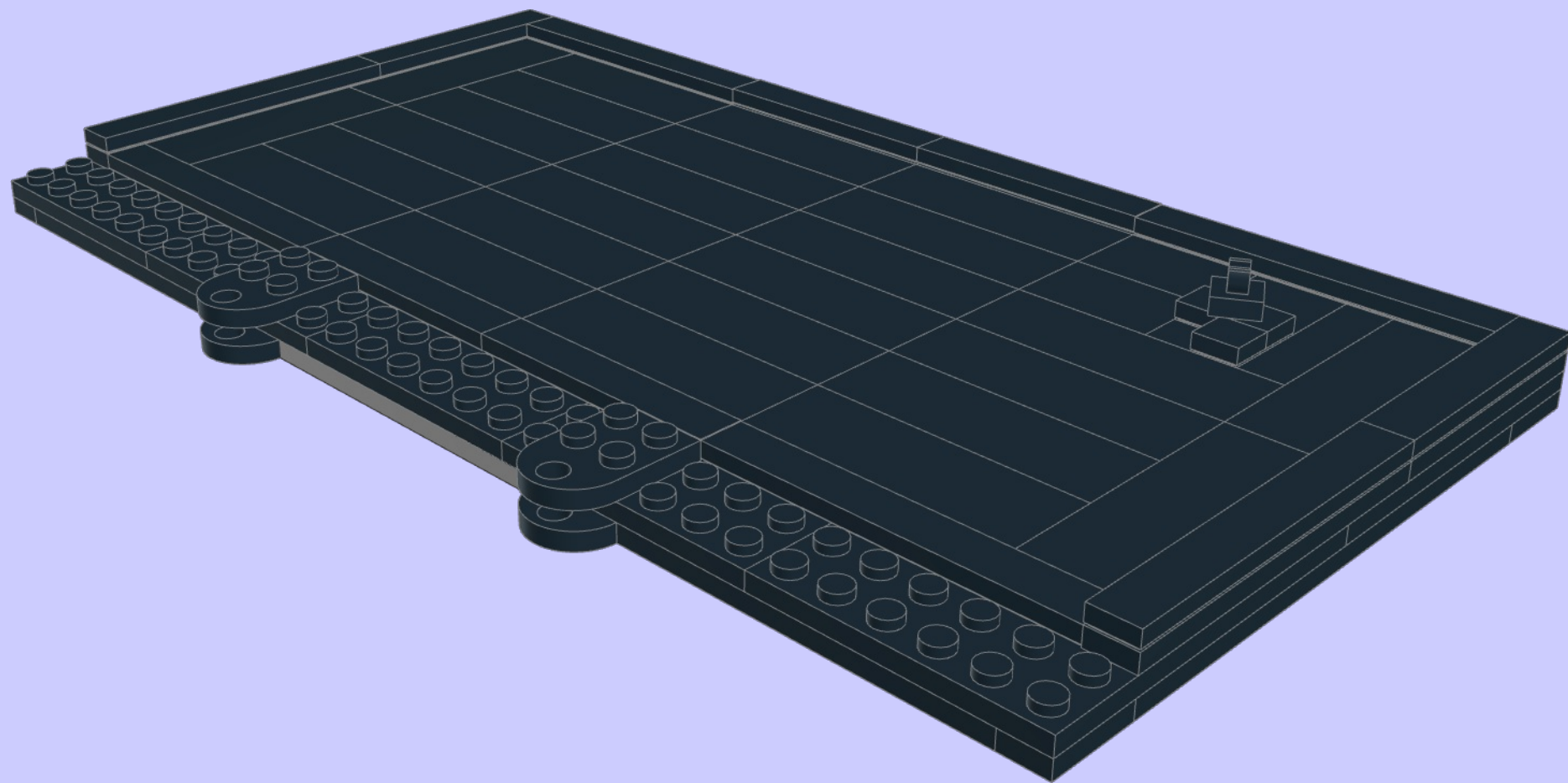

31

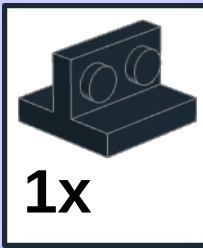
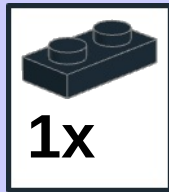
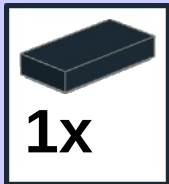
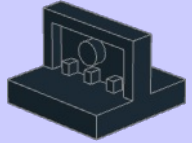
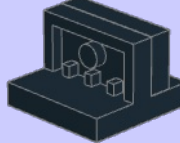
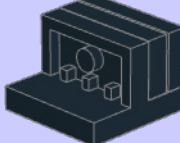
1	 1x	2	 1x	3	 1x
					

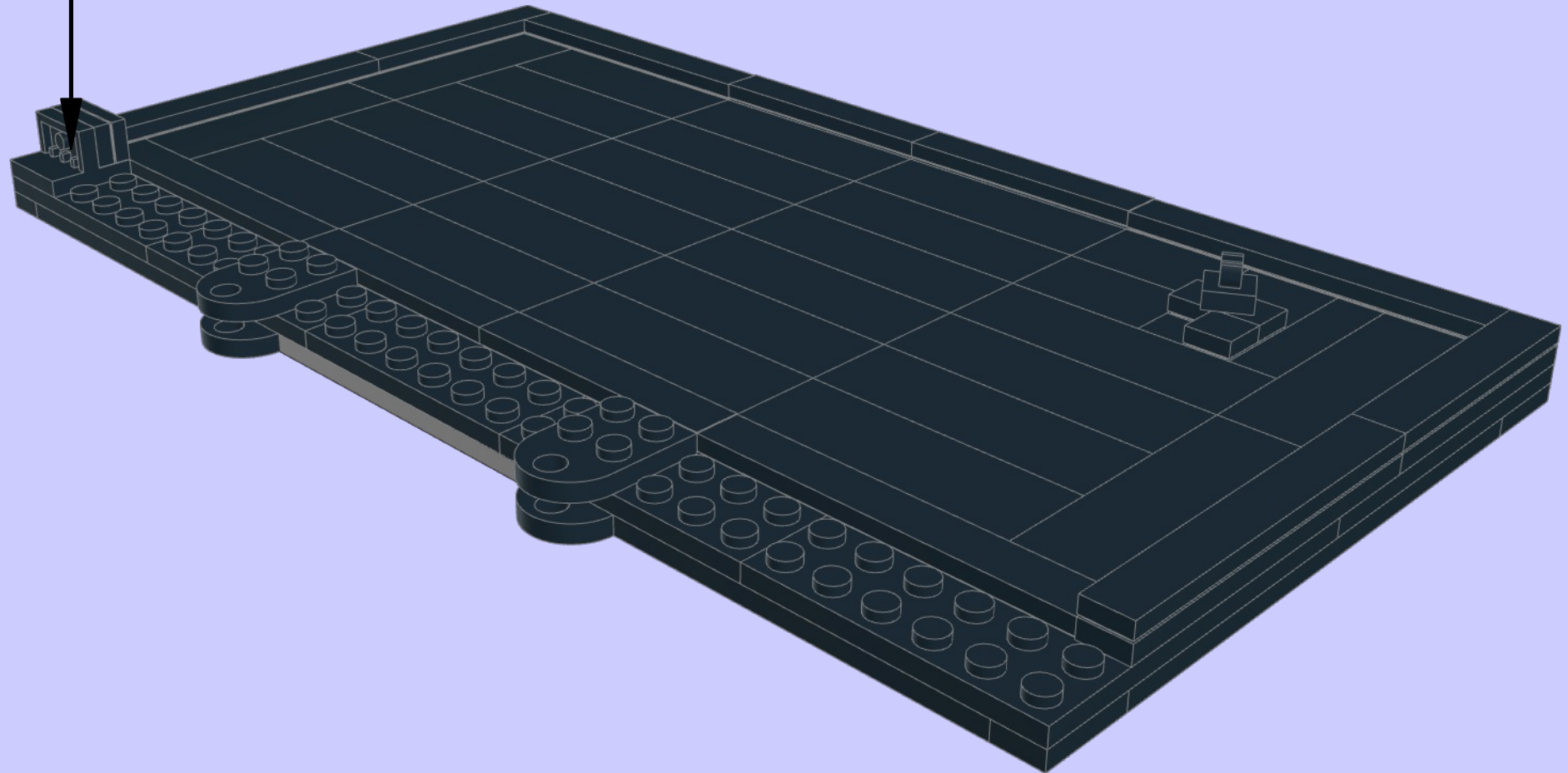

32

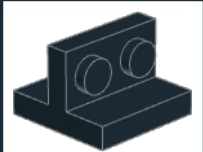
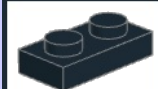
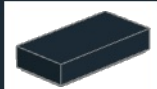
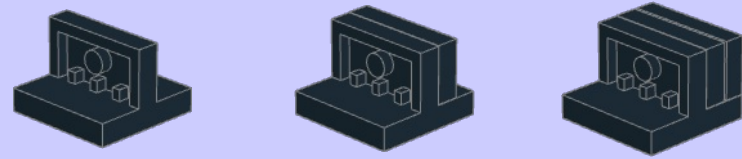
1	 1x	2	 1x	3	 1x
					

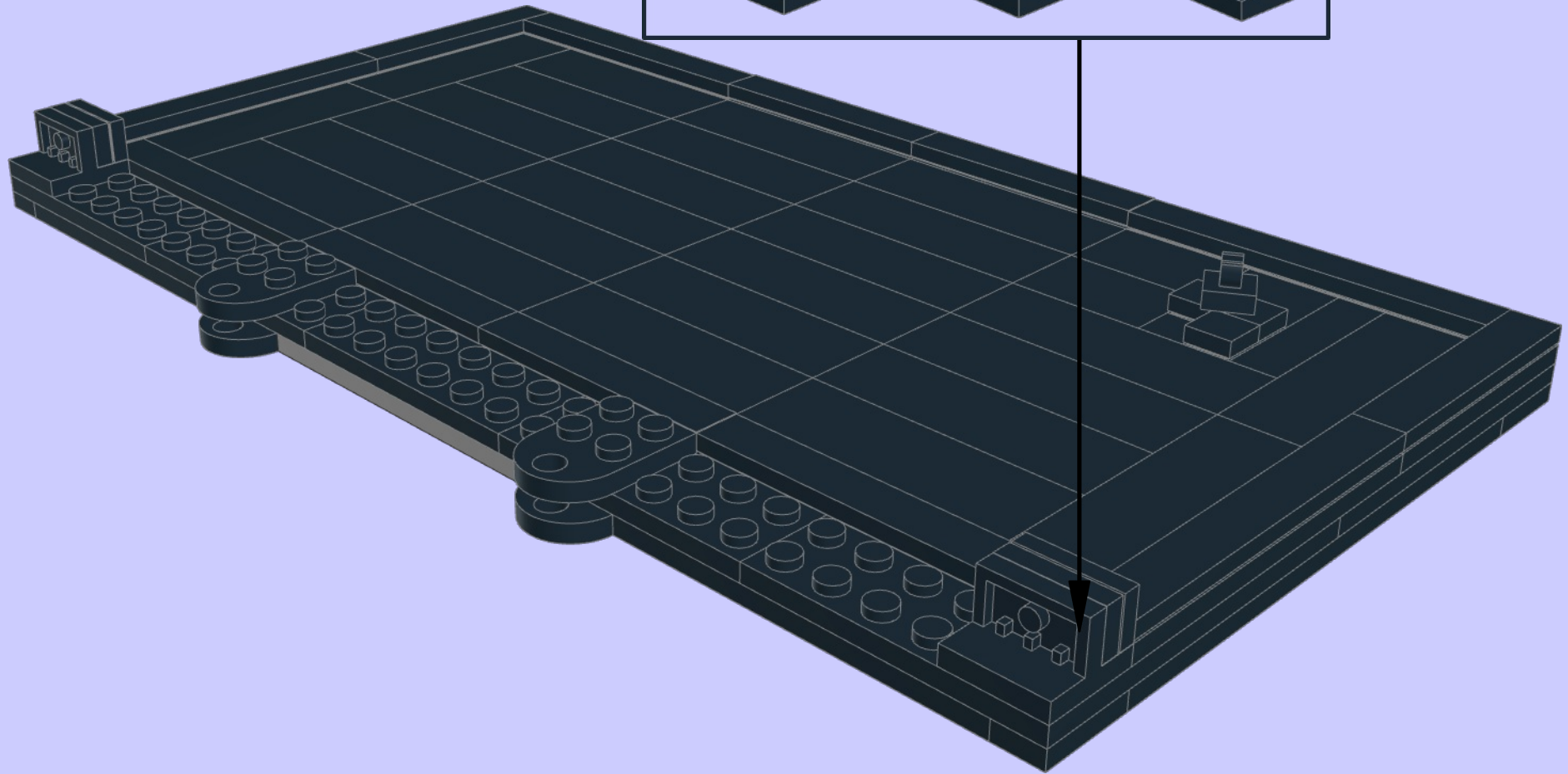

33

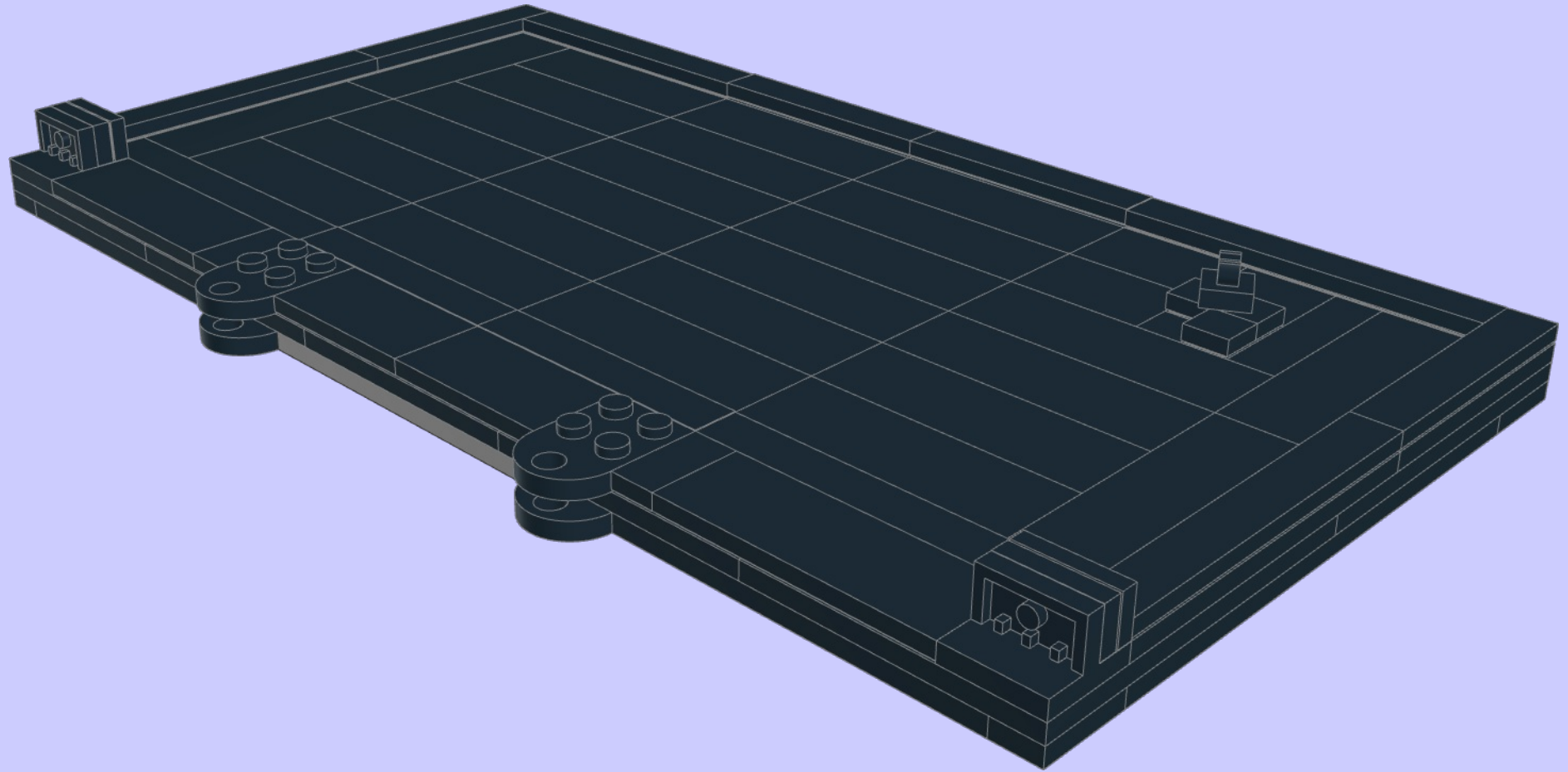
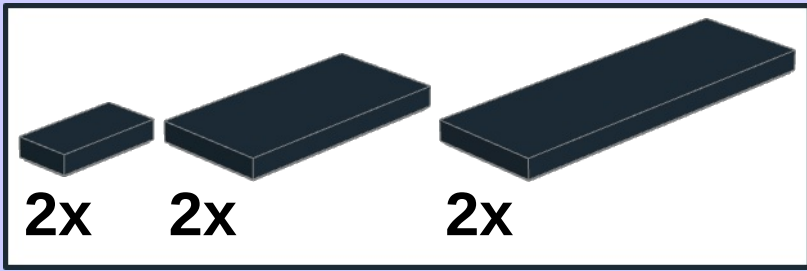

3

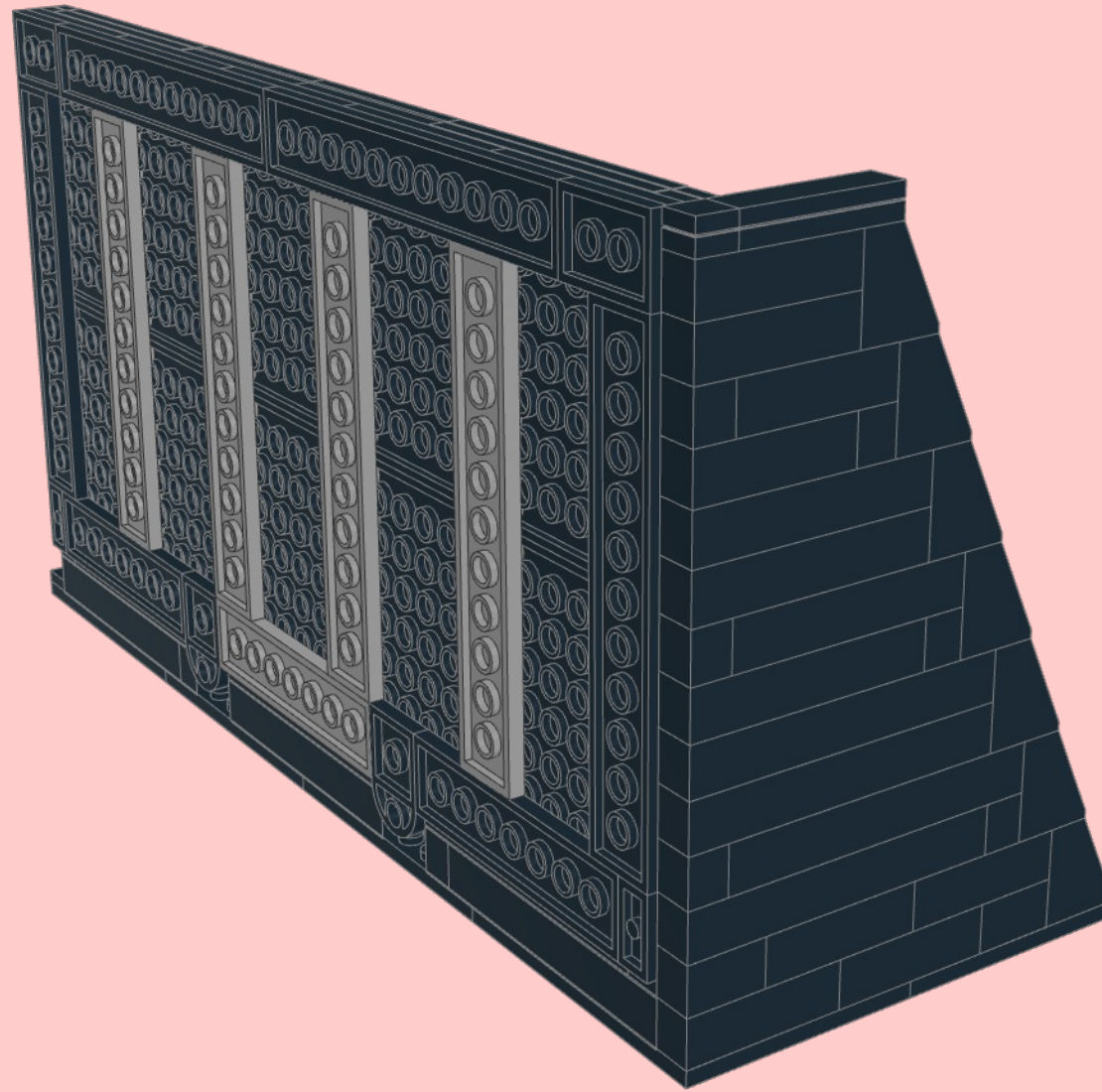

4

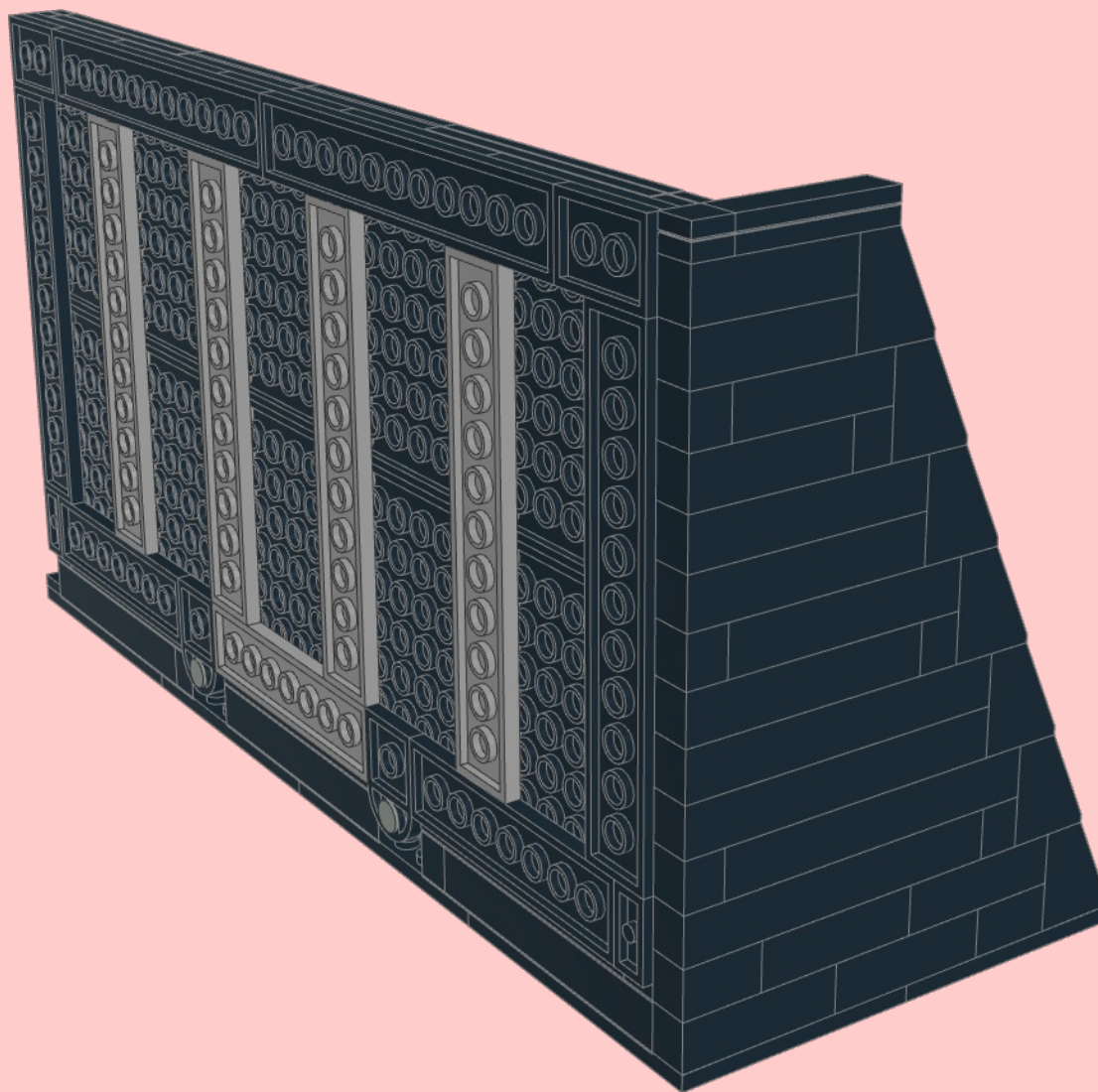
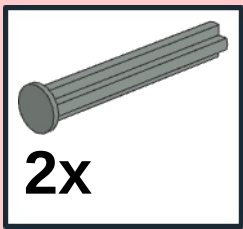

1

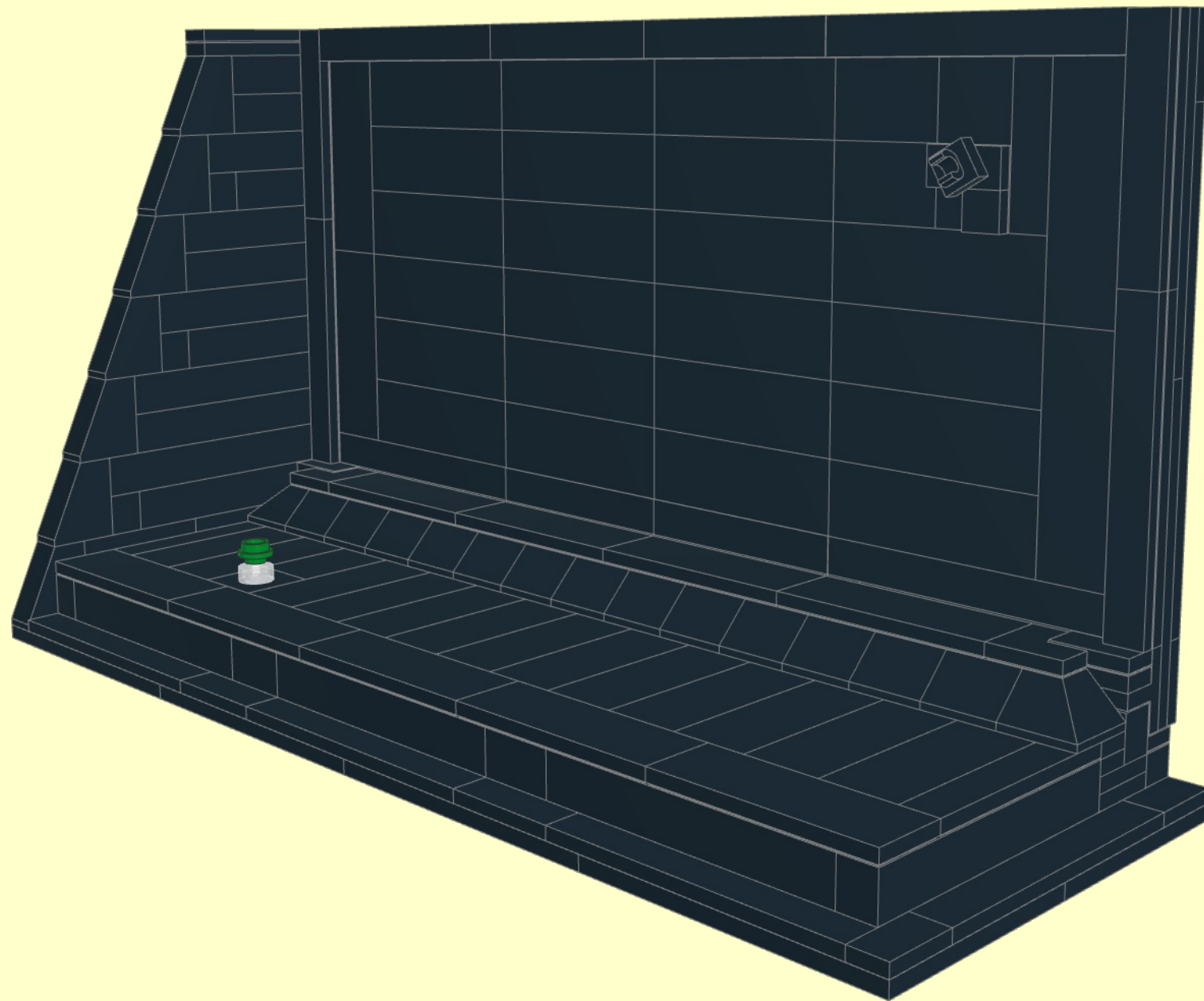

1

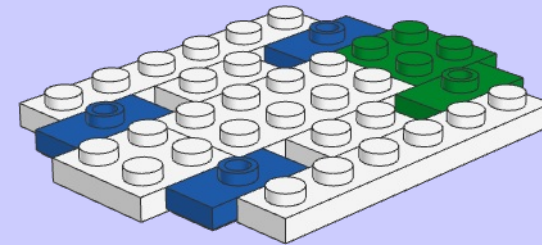
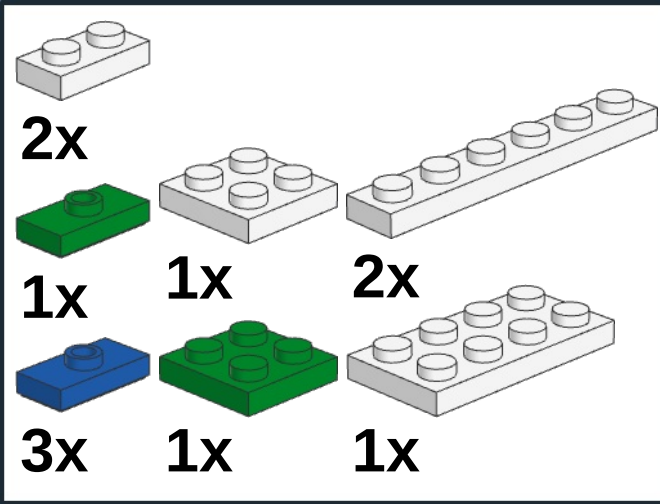

2

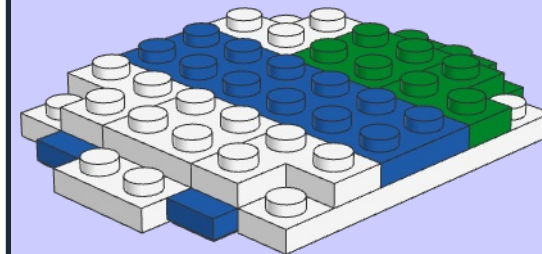
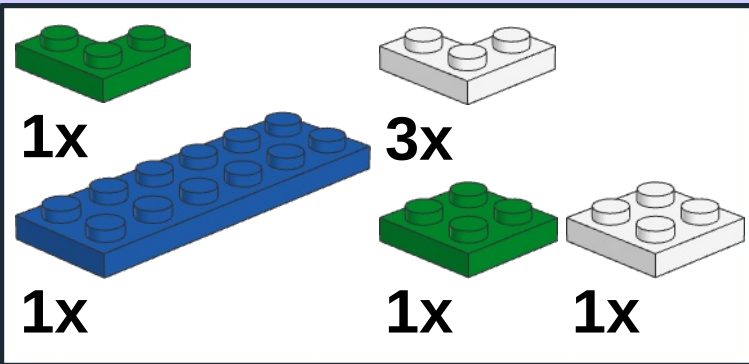

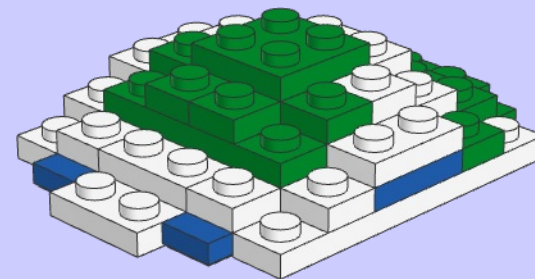
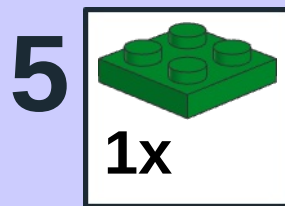
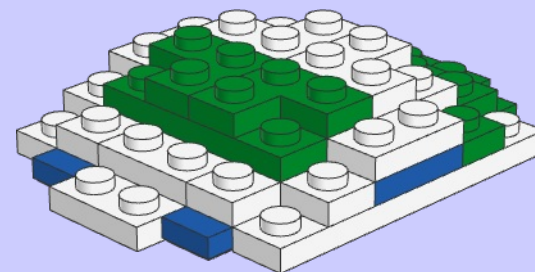
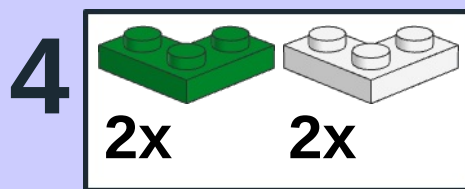
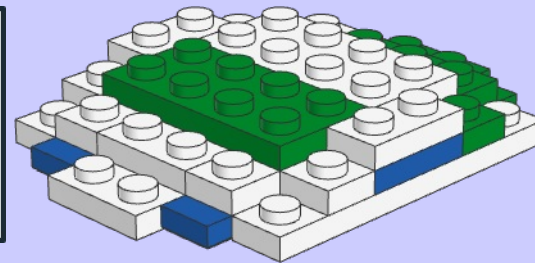
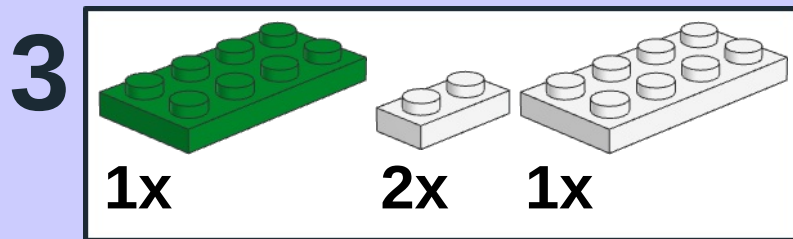

1

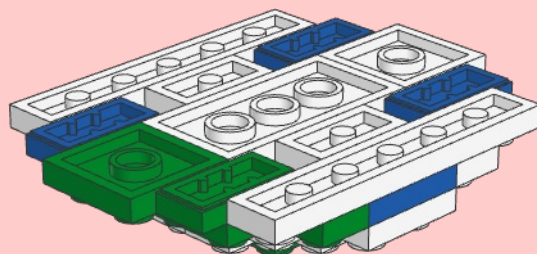

2
4x

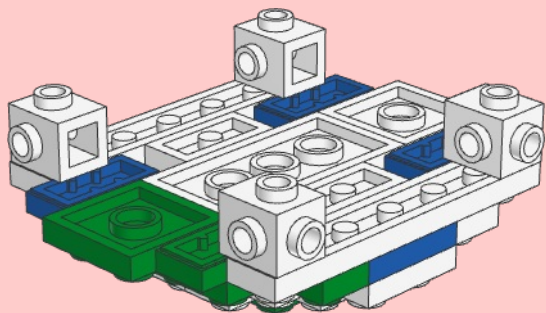

1

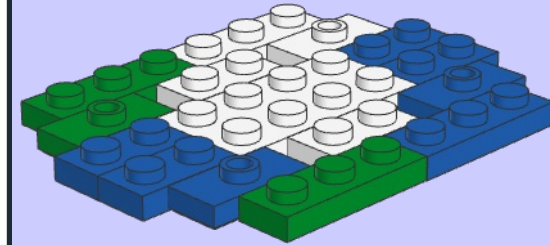
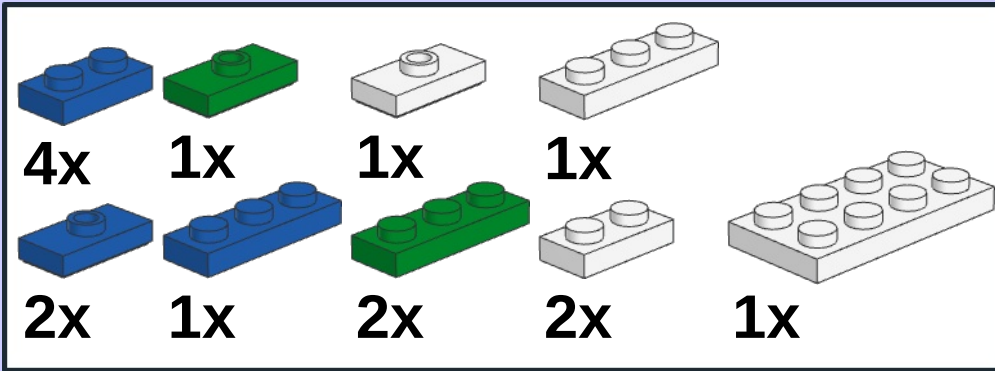

2

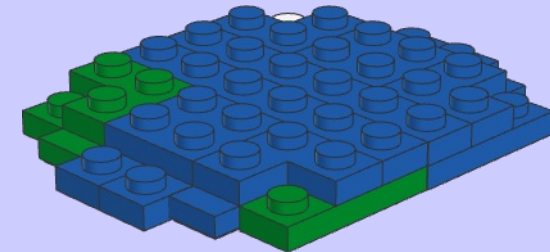
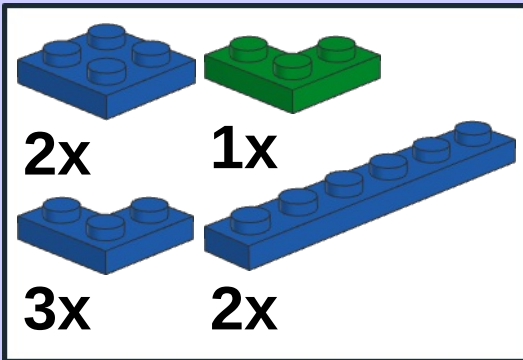

3

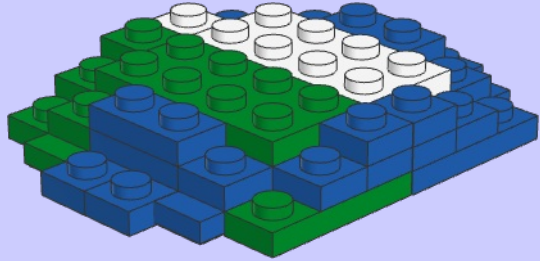
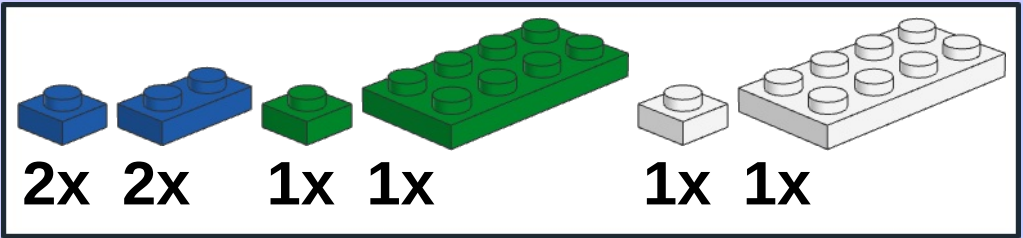

4

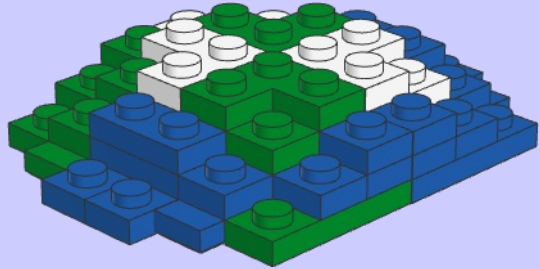
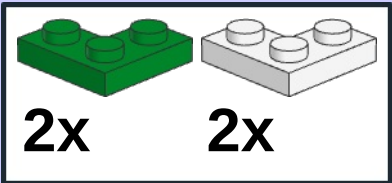

5

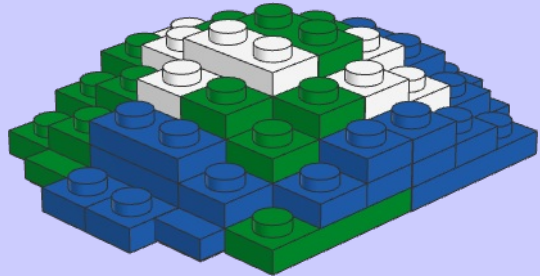
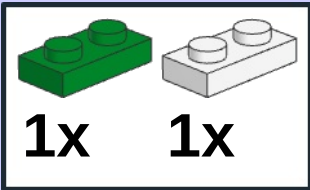

3

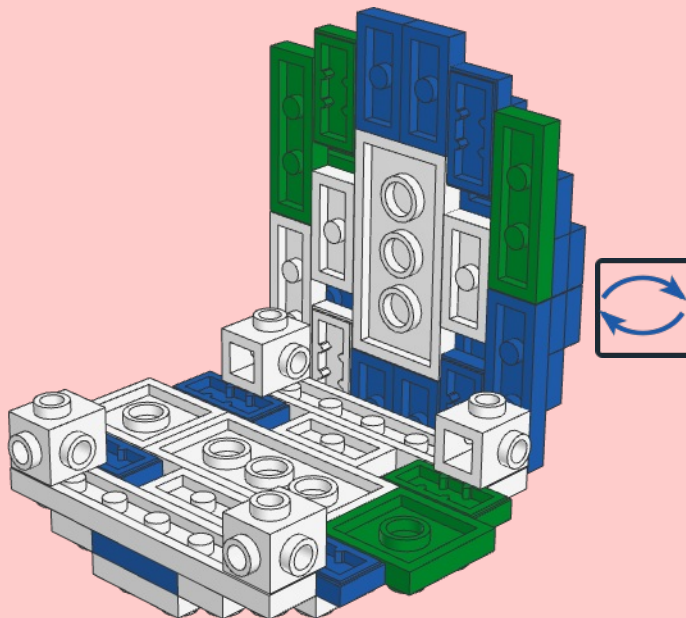

4

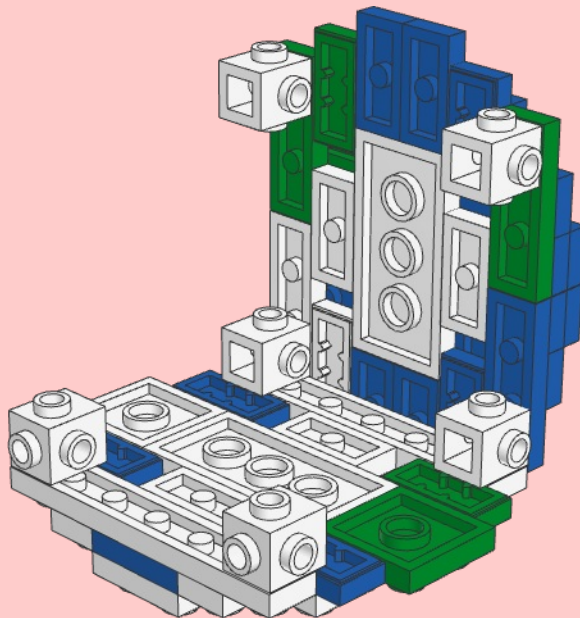
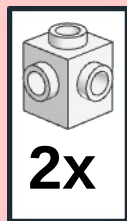

1

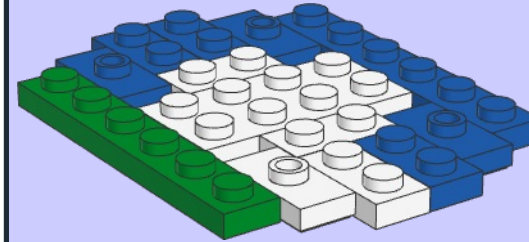
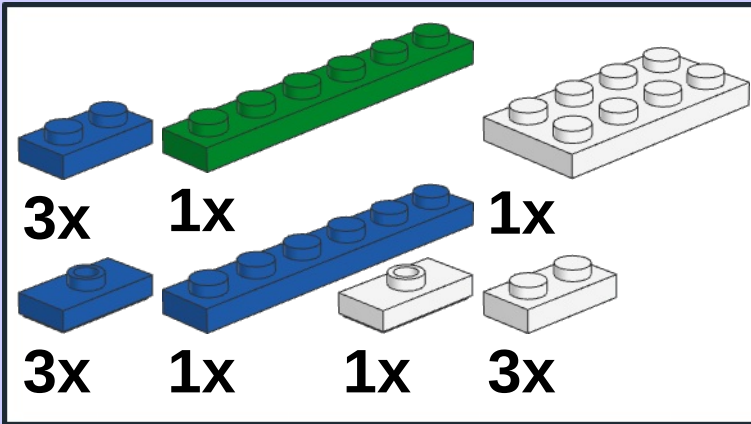

2

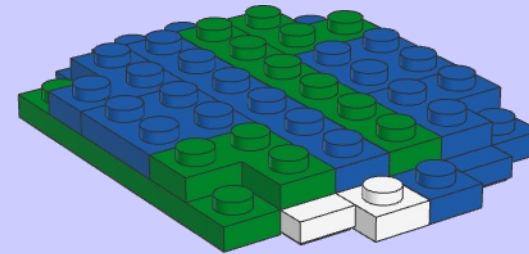
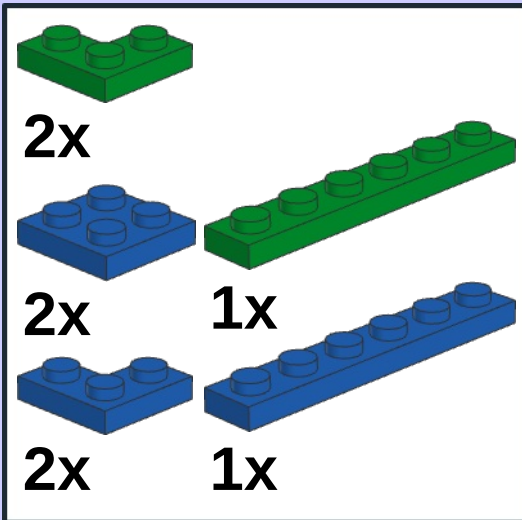

3

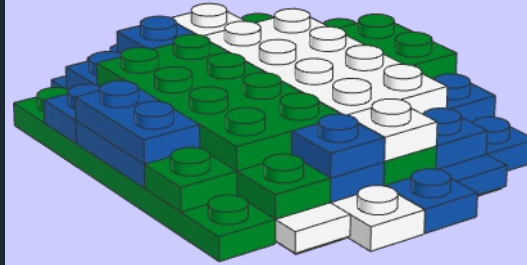
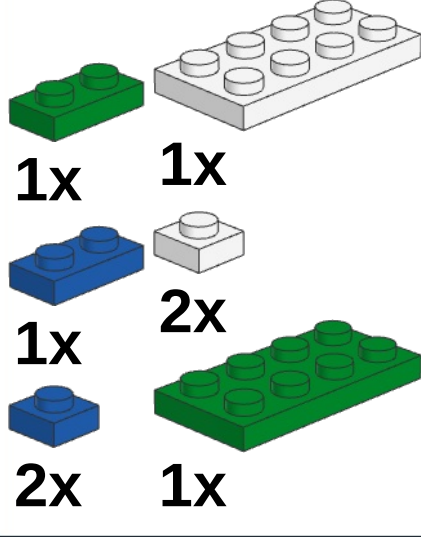

4

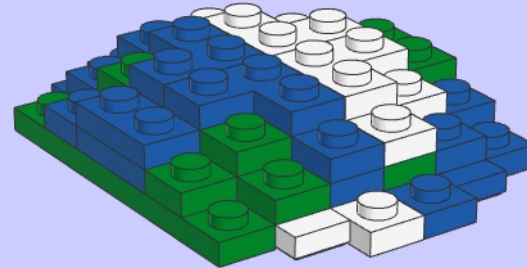
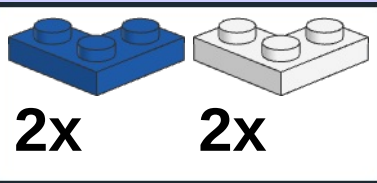

5

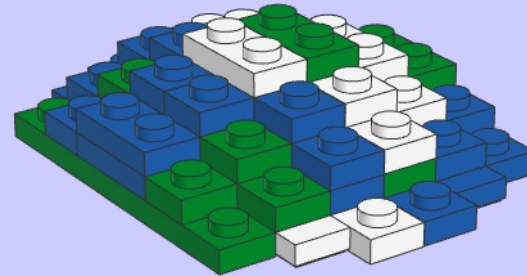
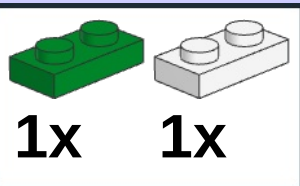

5

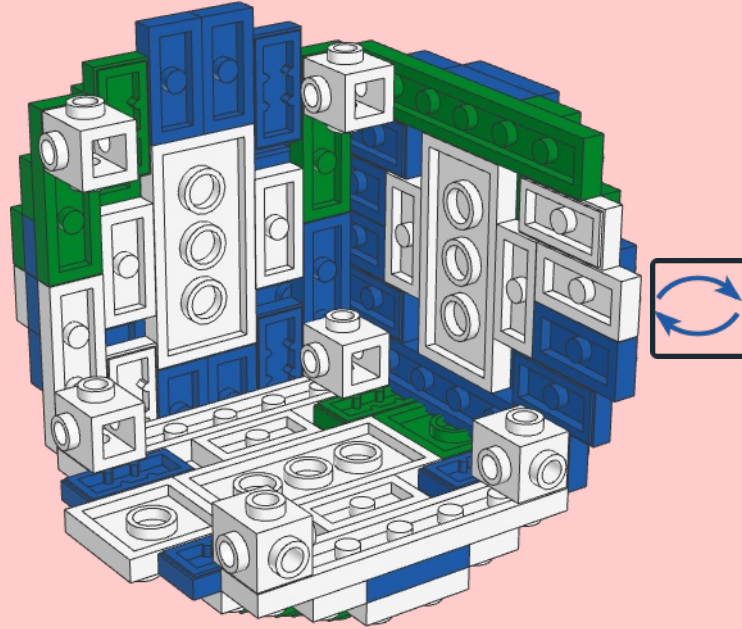

6

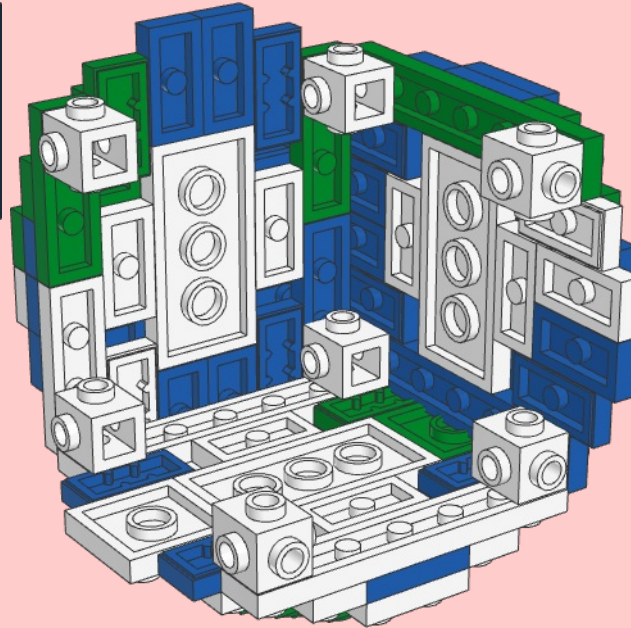
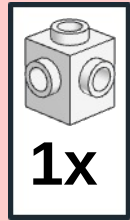

1

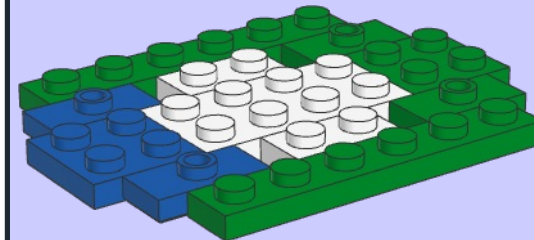
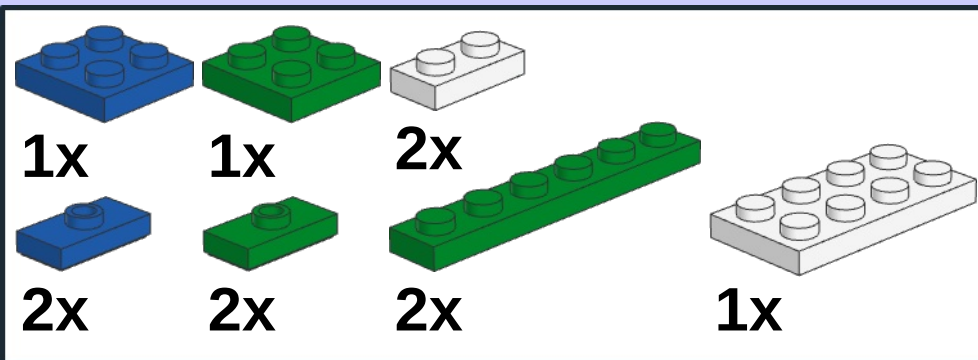

2

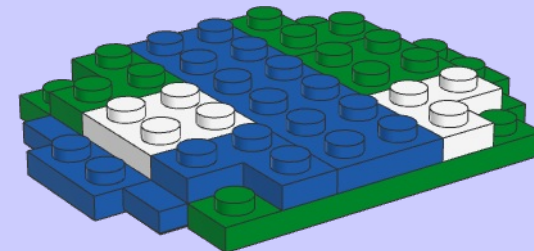
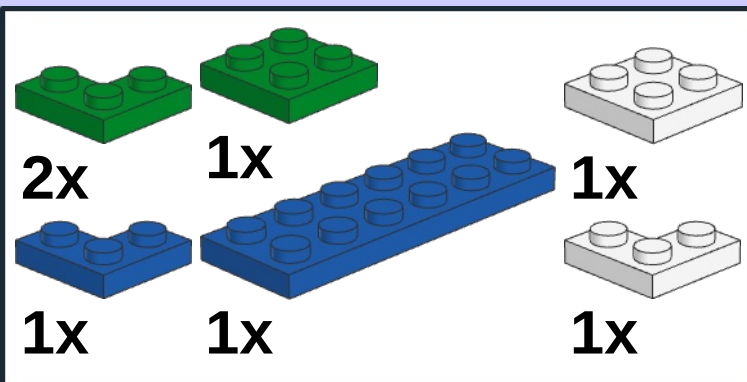

3

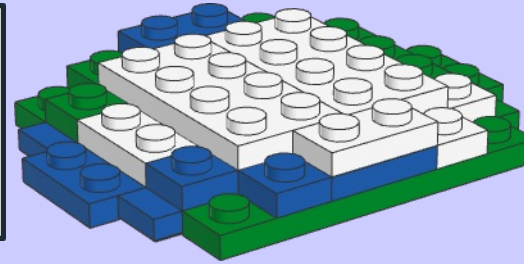
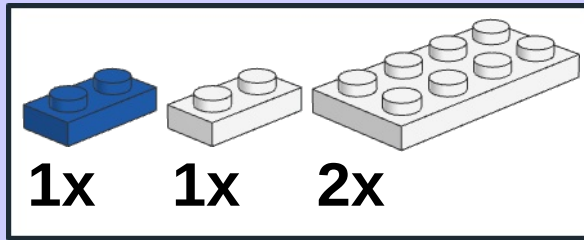

4

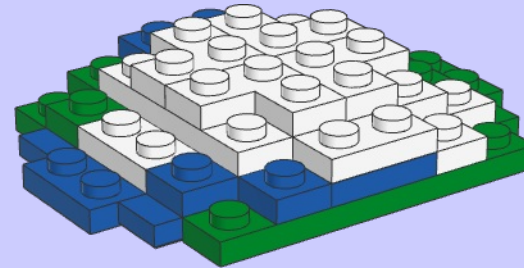
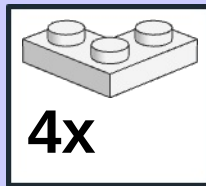

5

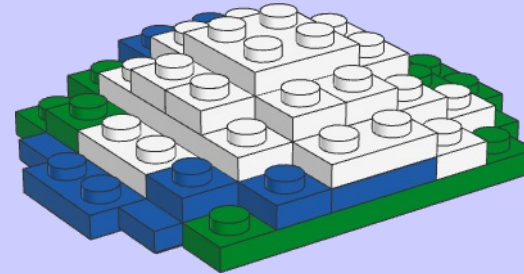
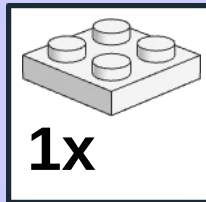

7

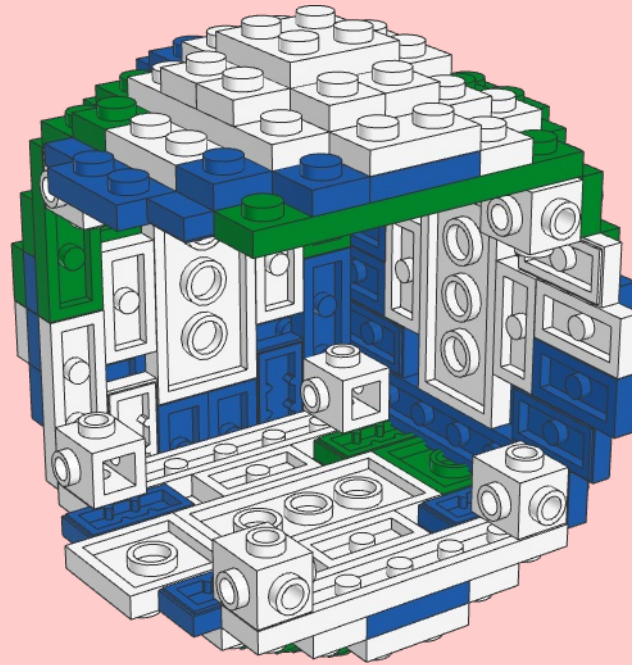

8

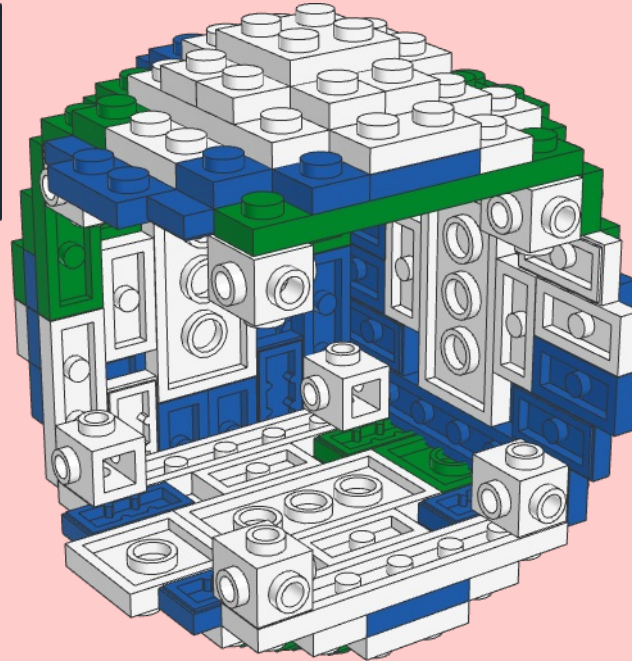
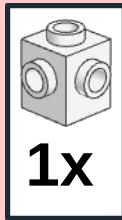

1

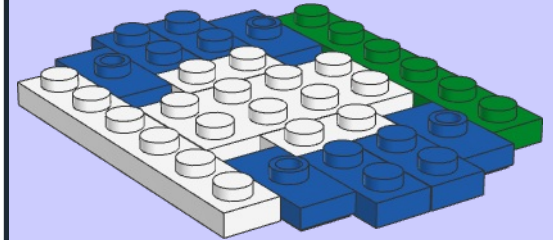
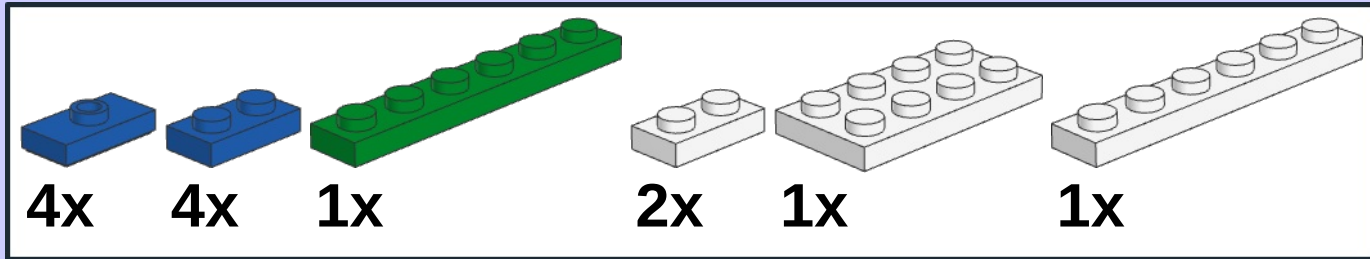

2

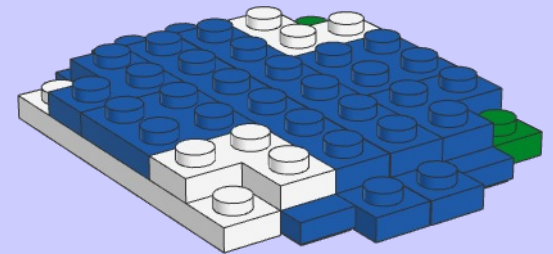
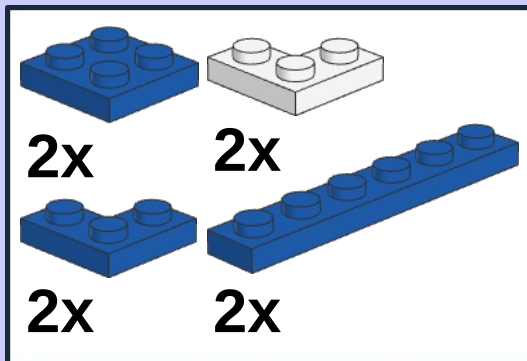

3

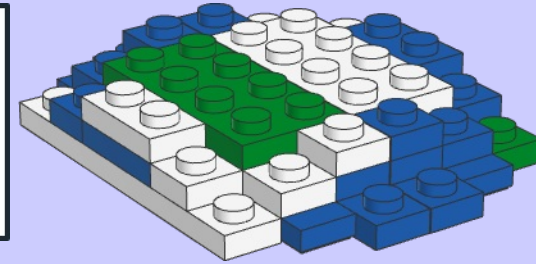
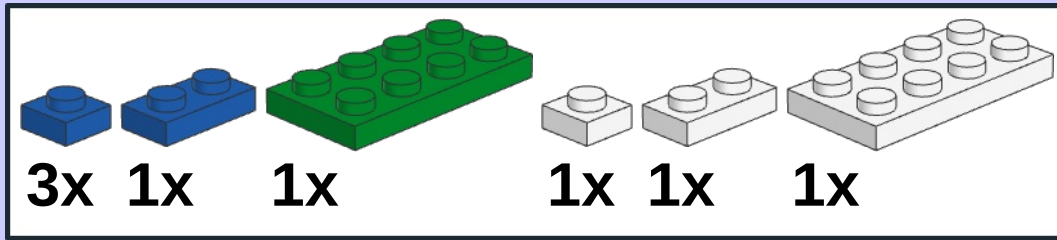

4

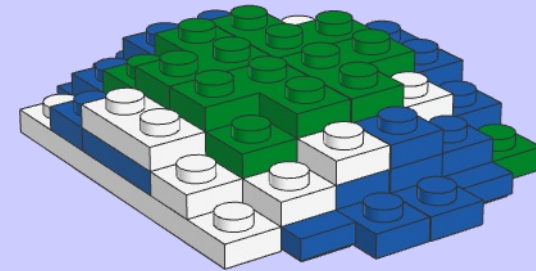
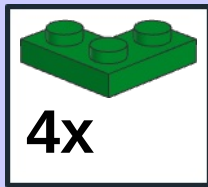

5

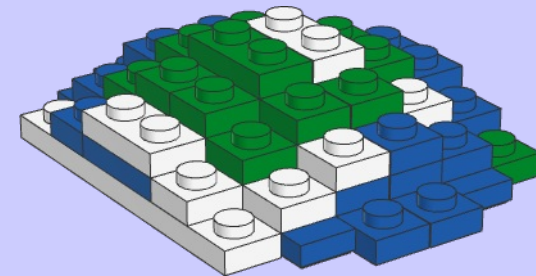
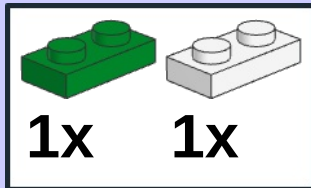

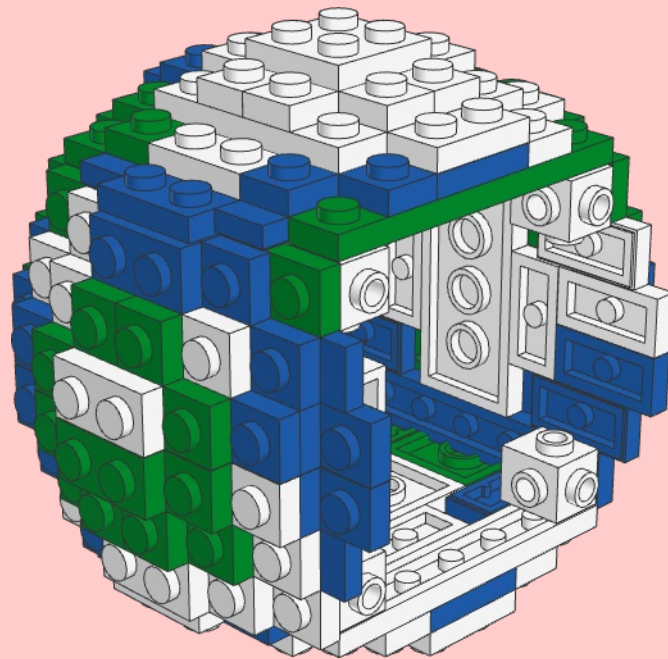

1

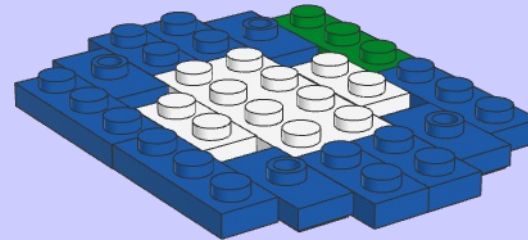
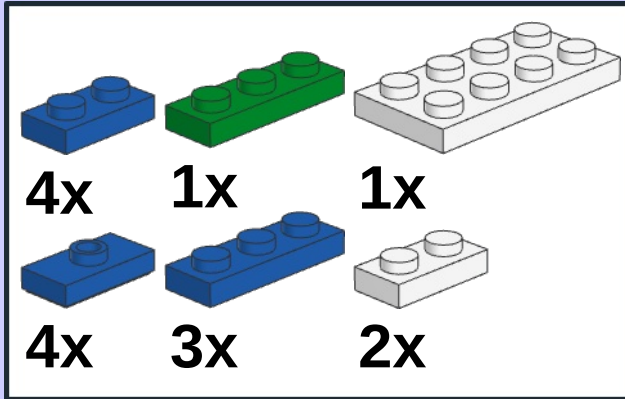

2

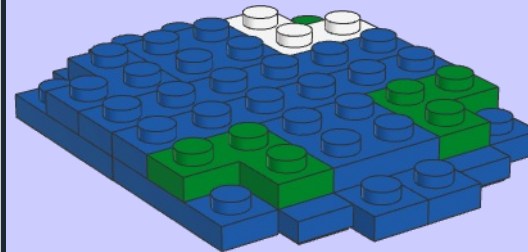
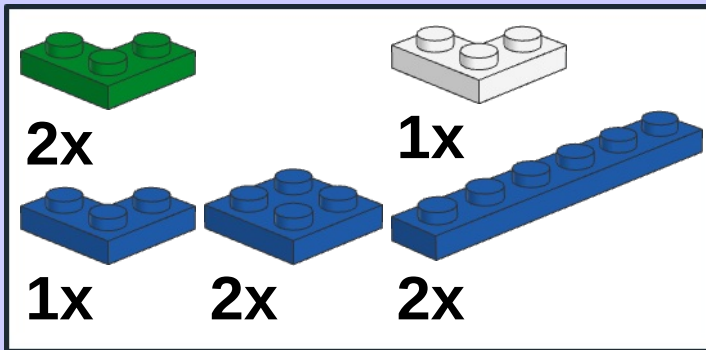

3

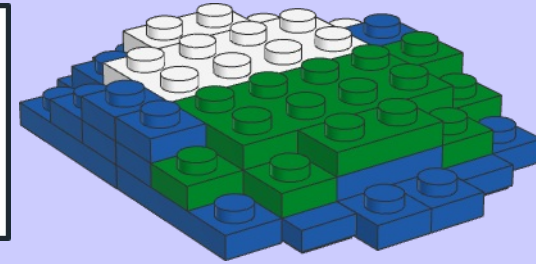
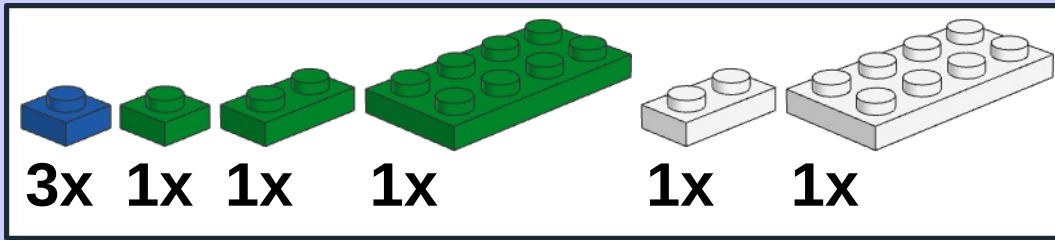

4

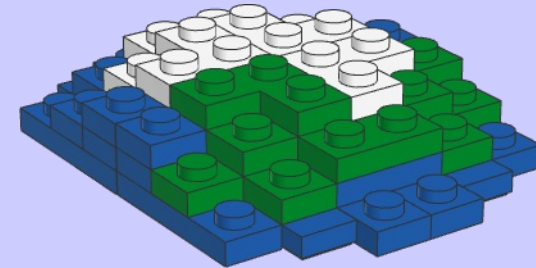
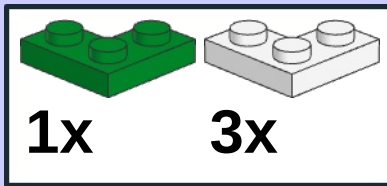

5

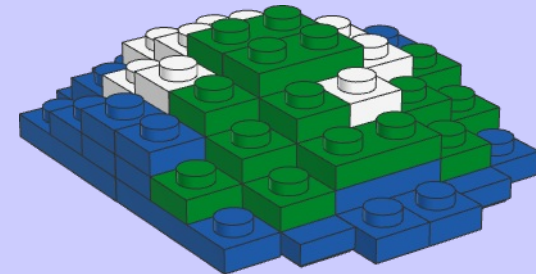
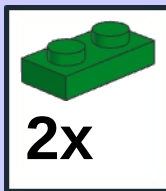

10

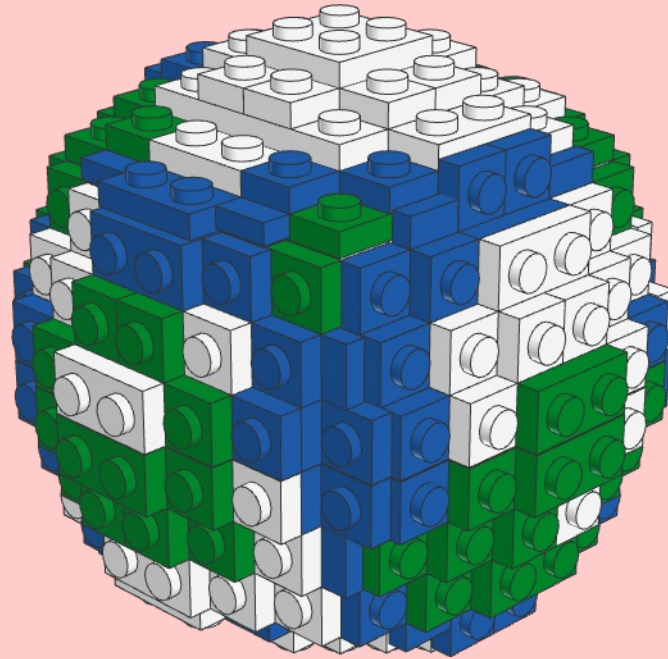

2

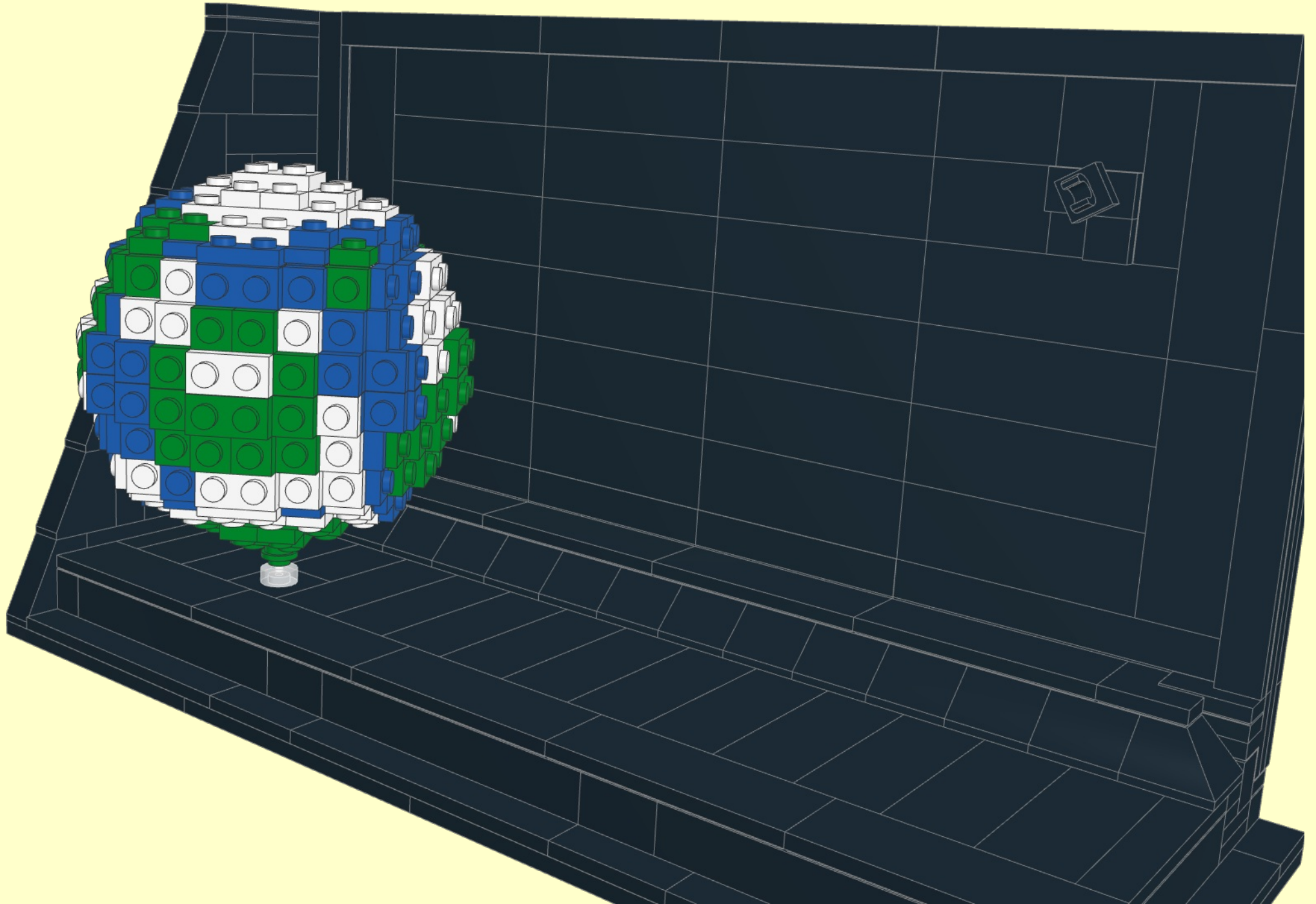

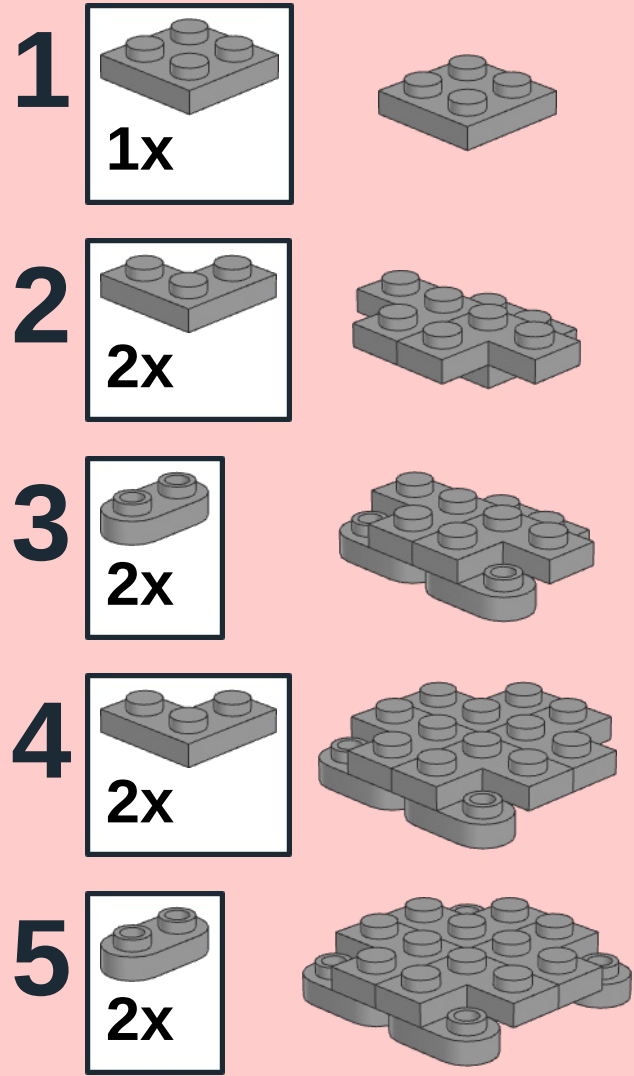

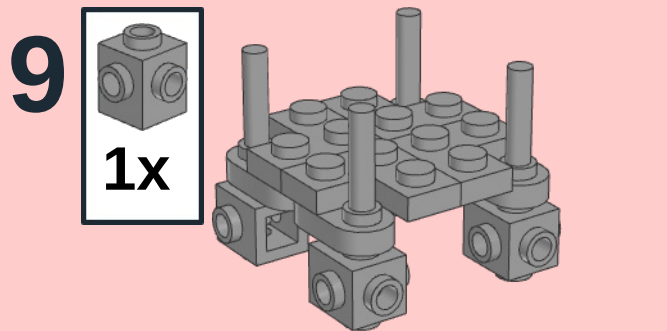
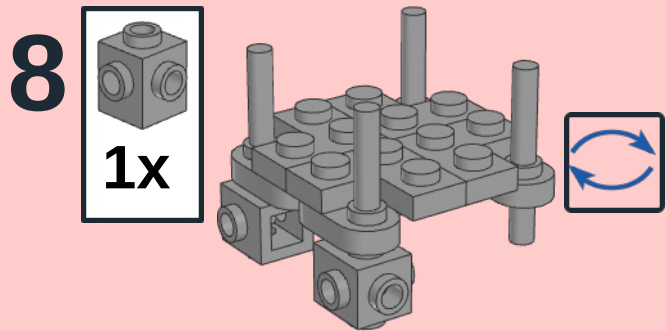
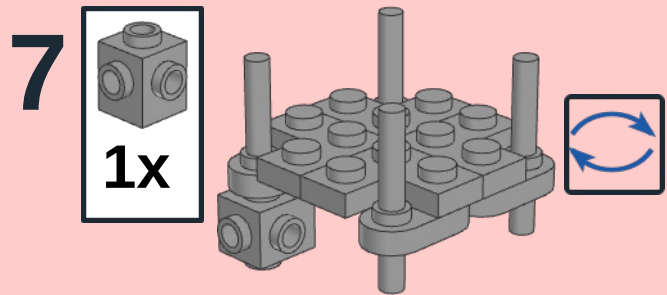
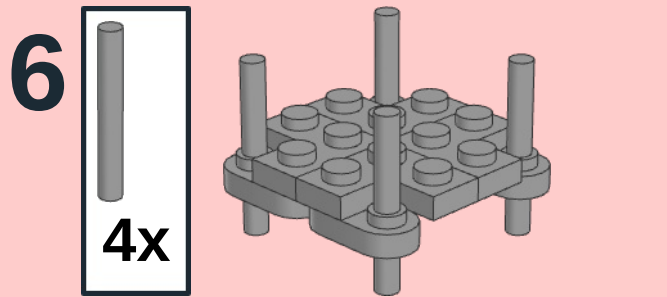

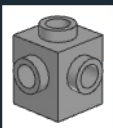

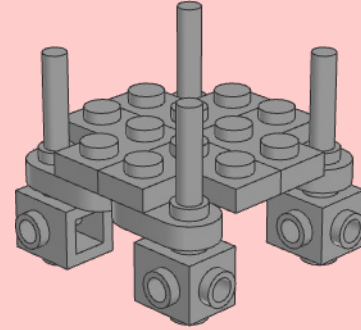
10 
1x

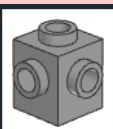

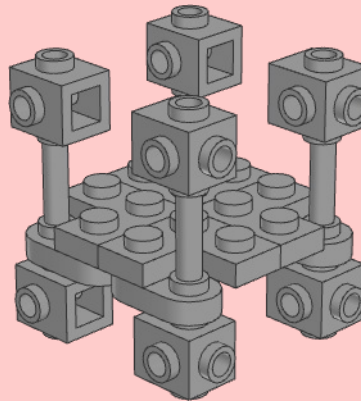
11 
4x



12 
2x

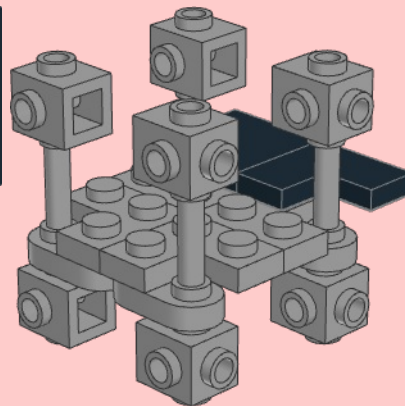

13

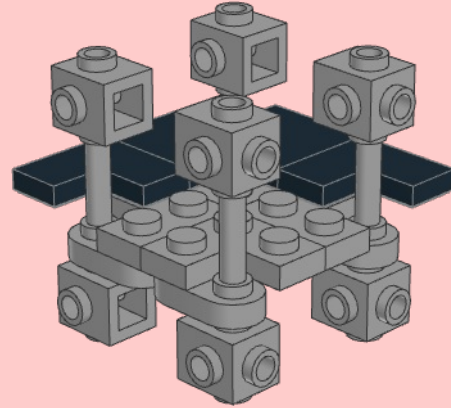
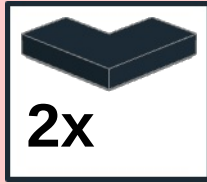

14

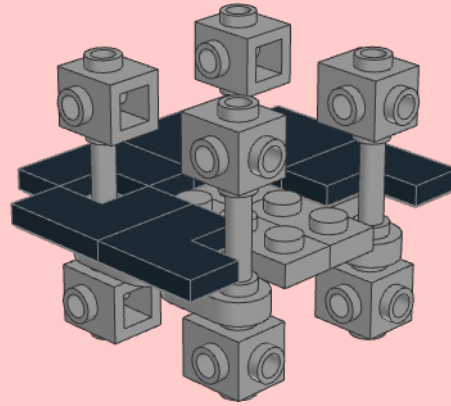
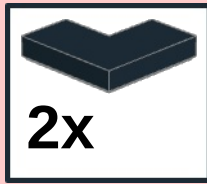

15

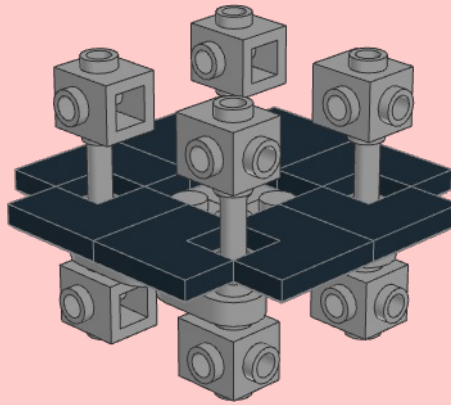

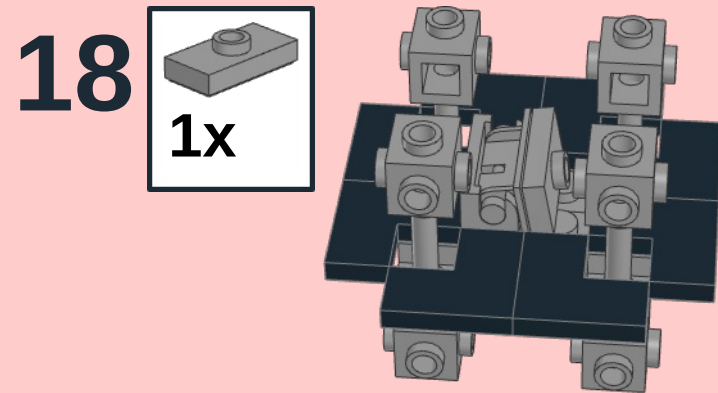
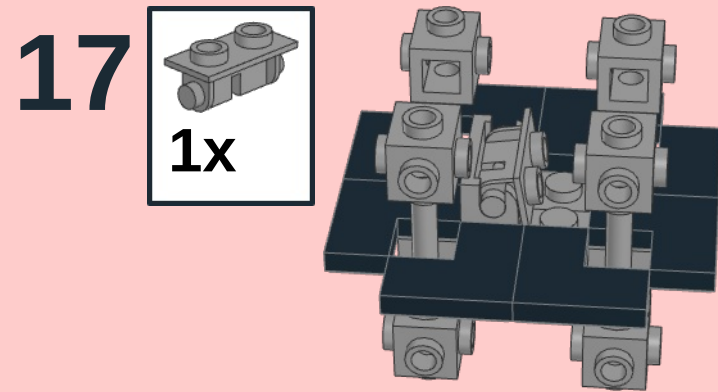
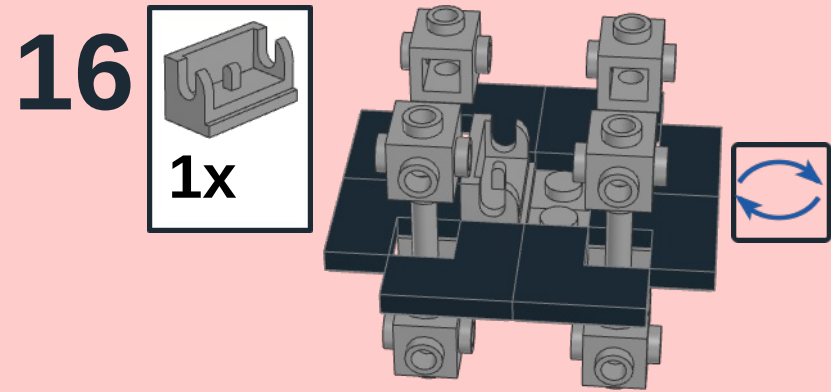

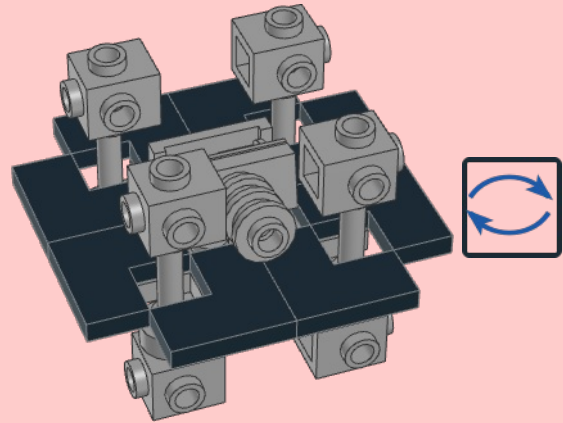

19  3x

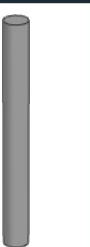

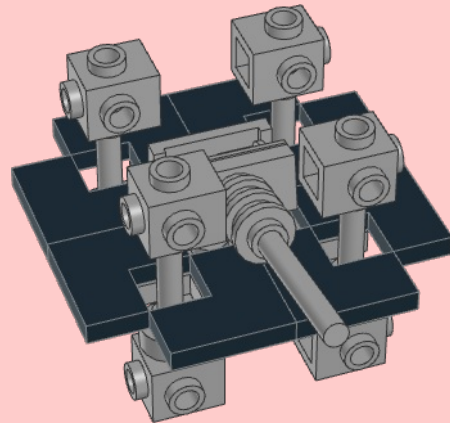
20  1x



21  1x

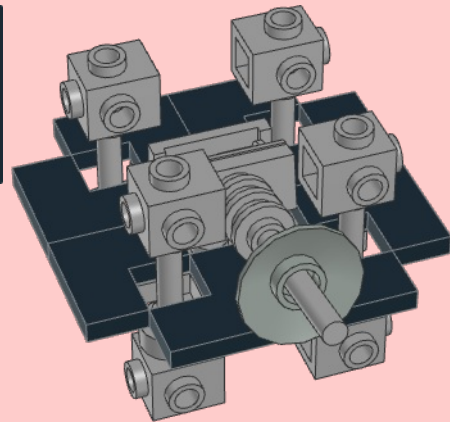

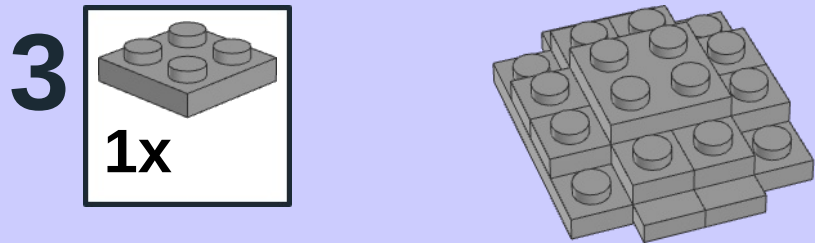
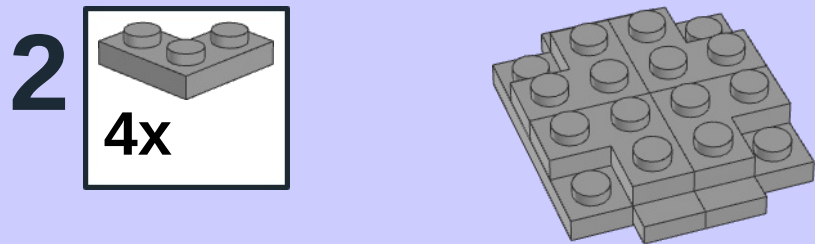
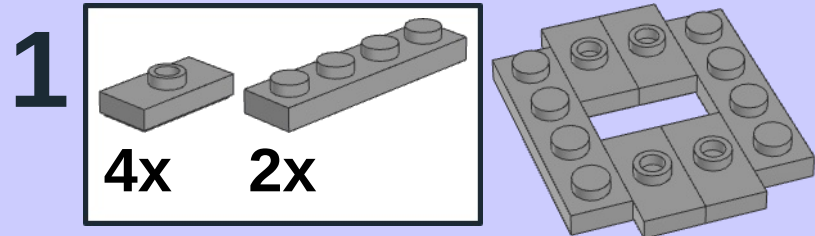

x2

22

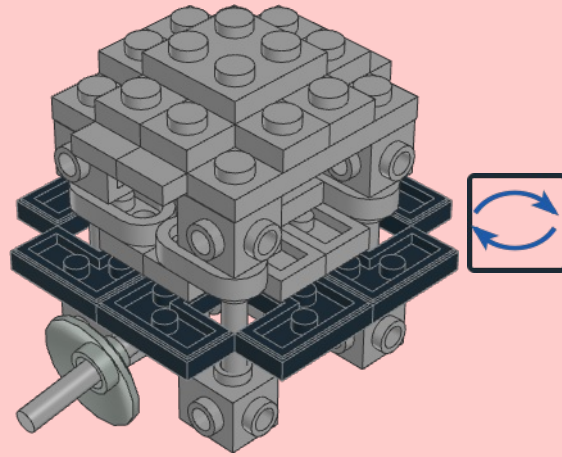

23

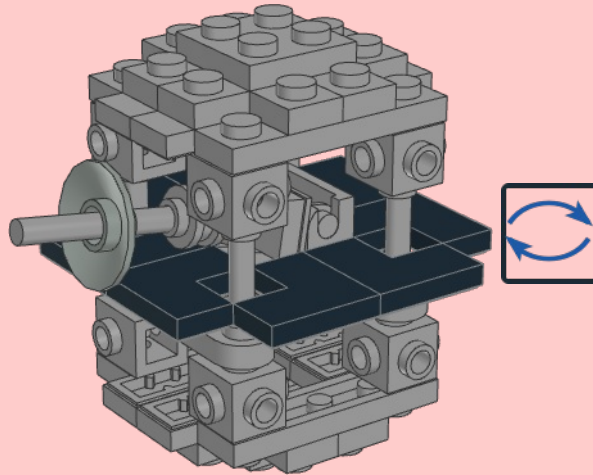

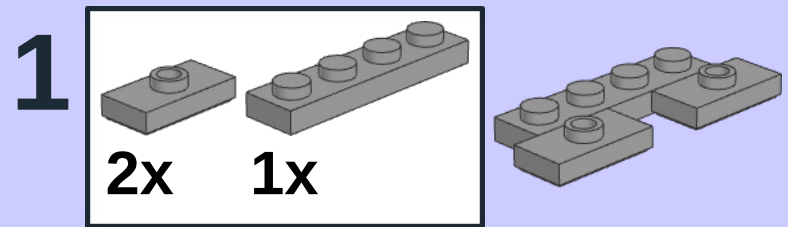

x3

24

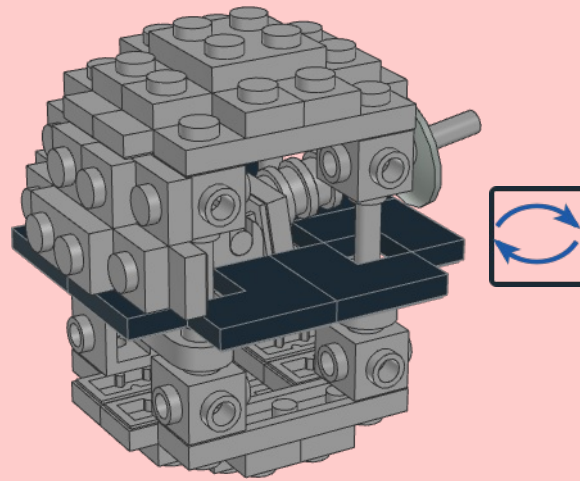

25

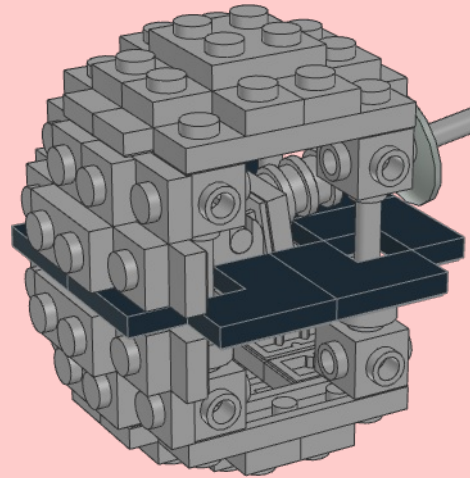

26

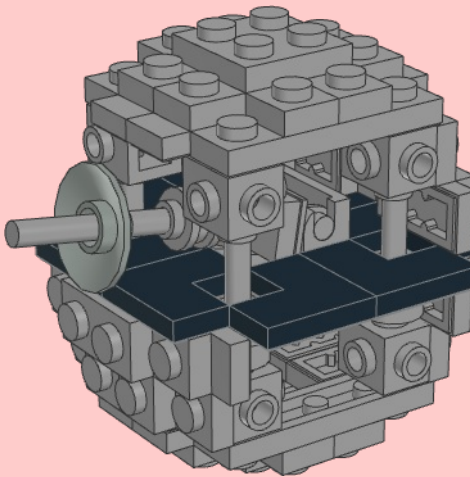

1

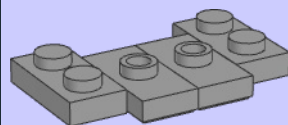
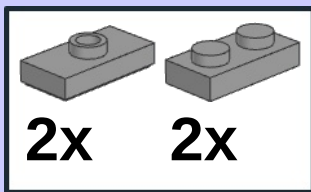

2

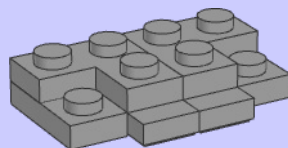
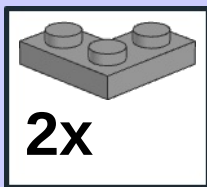

3

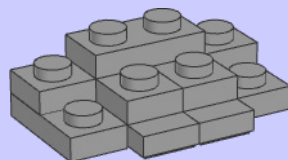
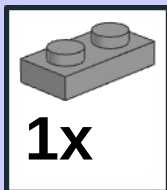

x4

27

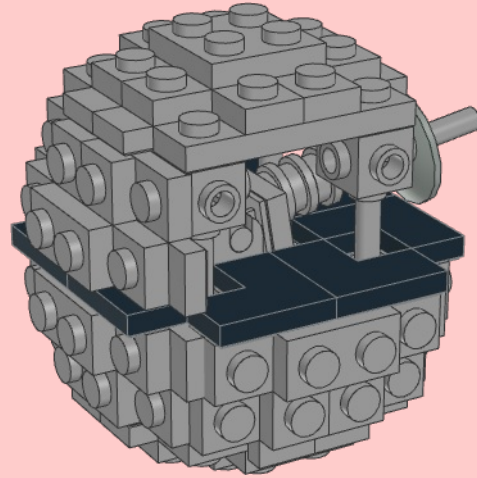

28

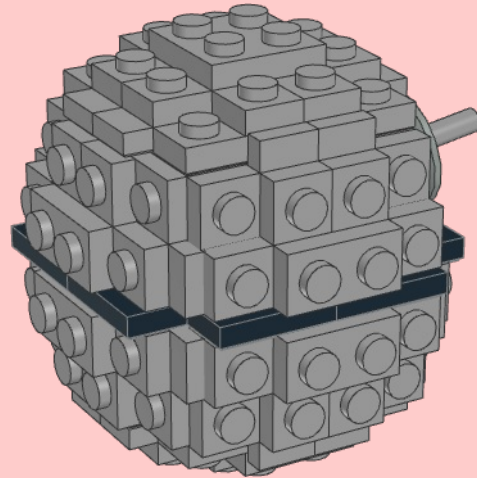

29

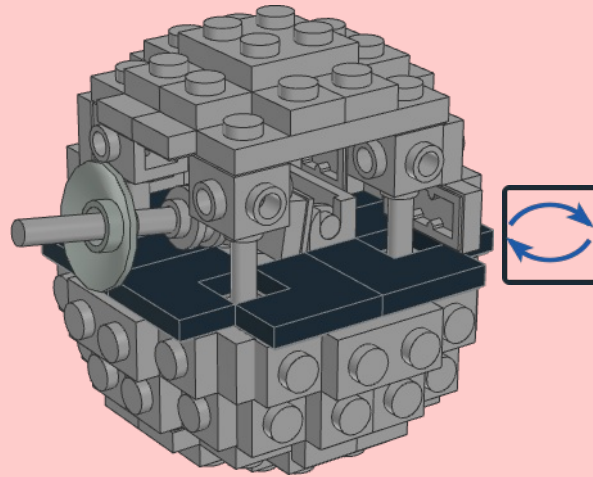

30

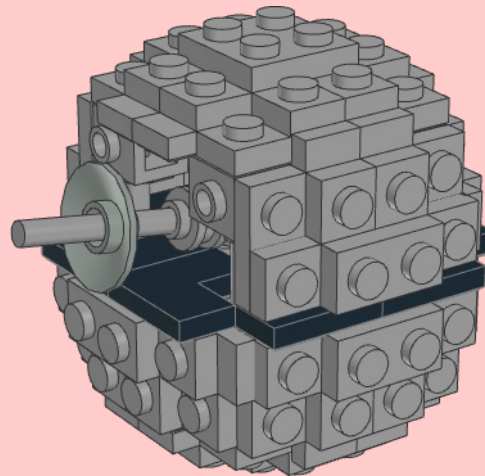

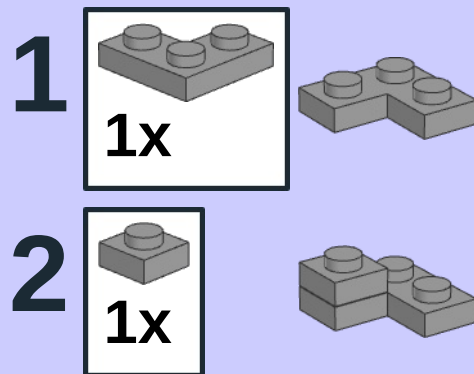

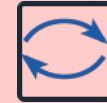
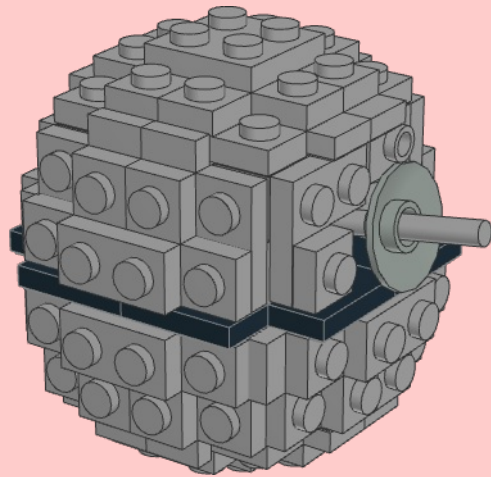

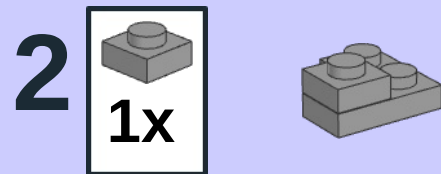
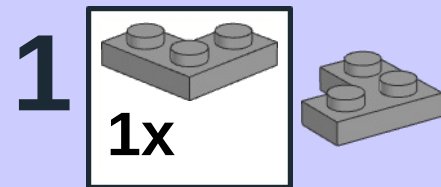

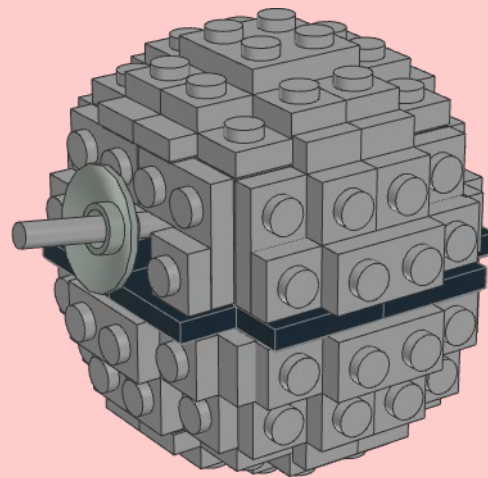

33

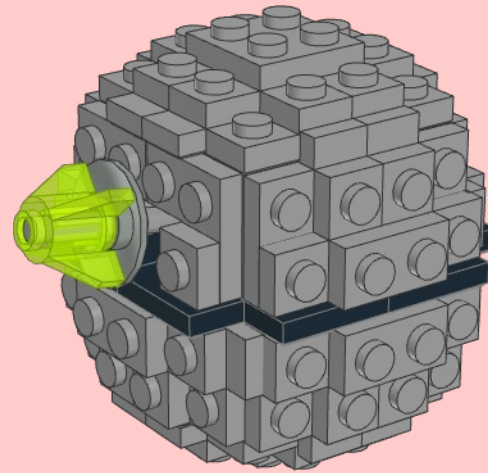

34

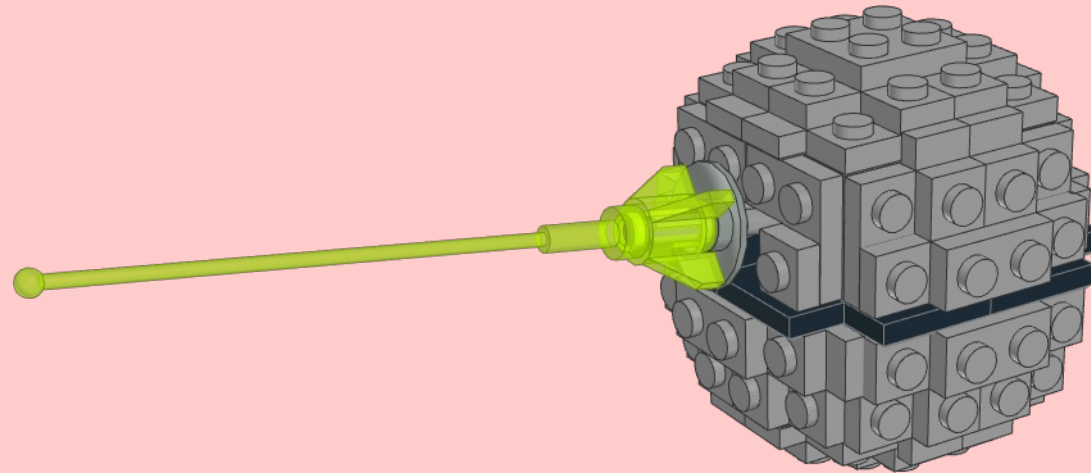

35

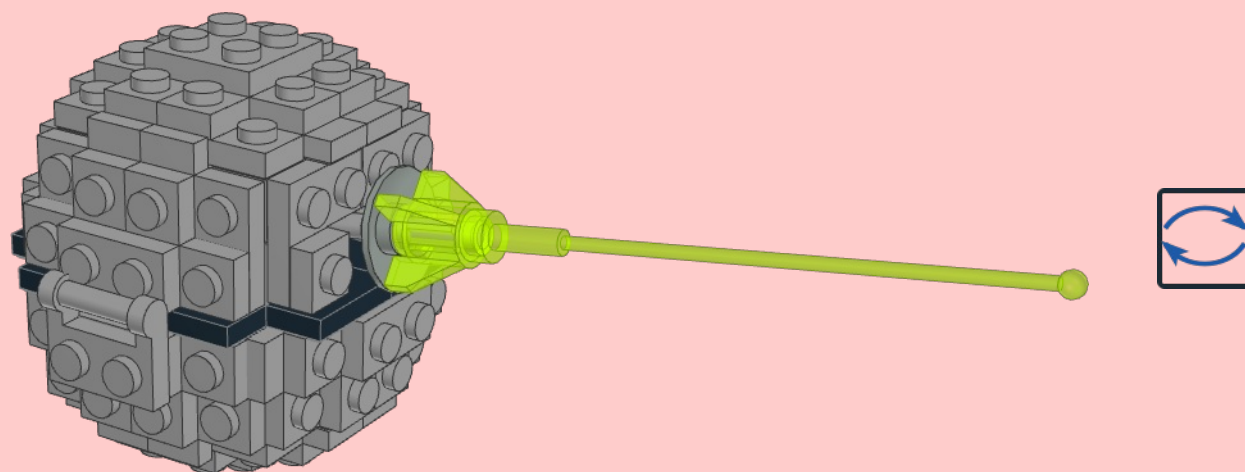
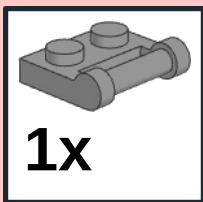

3

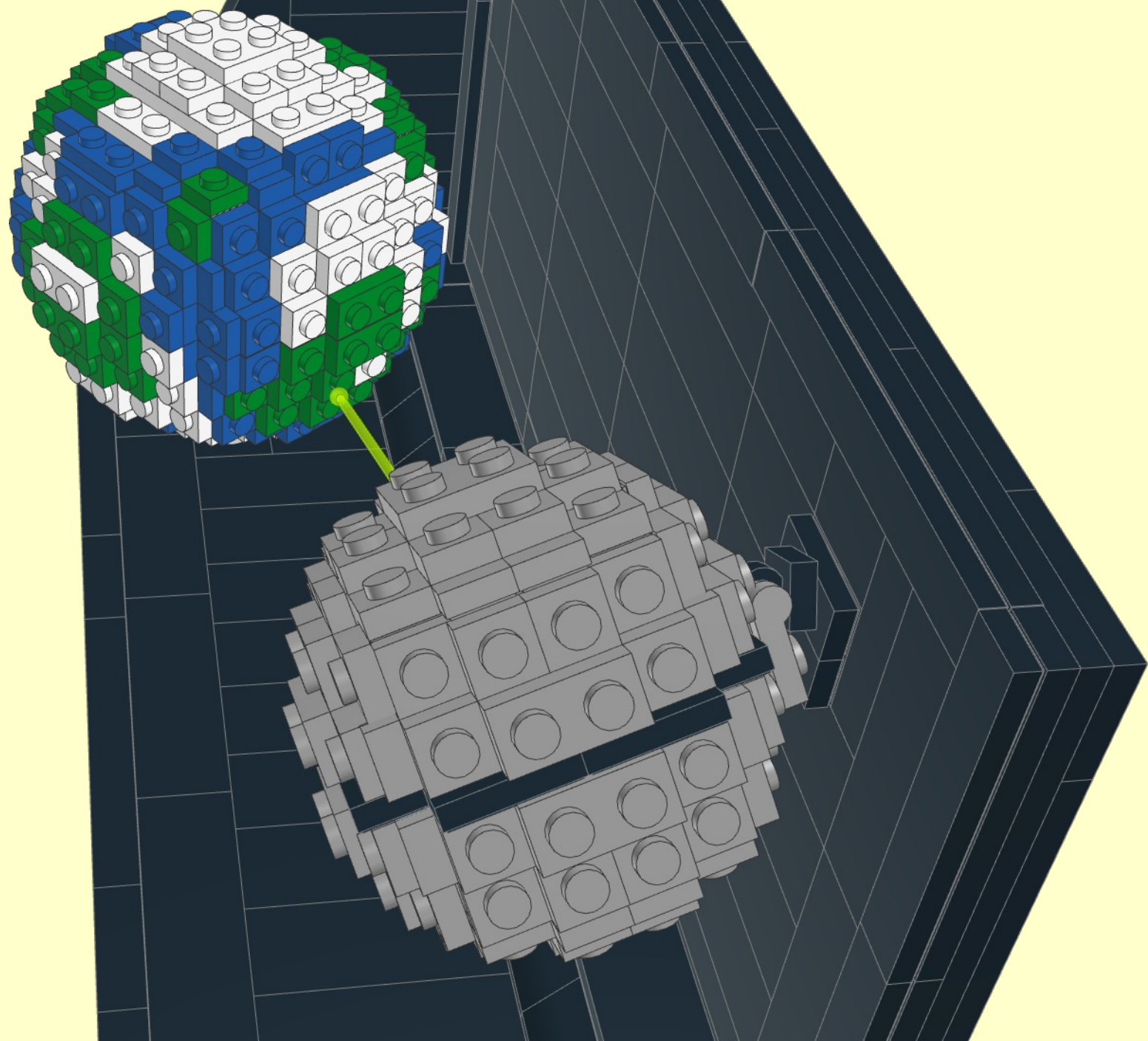

1

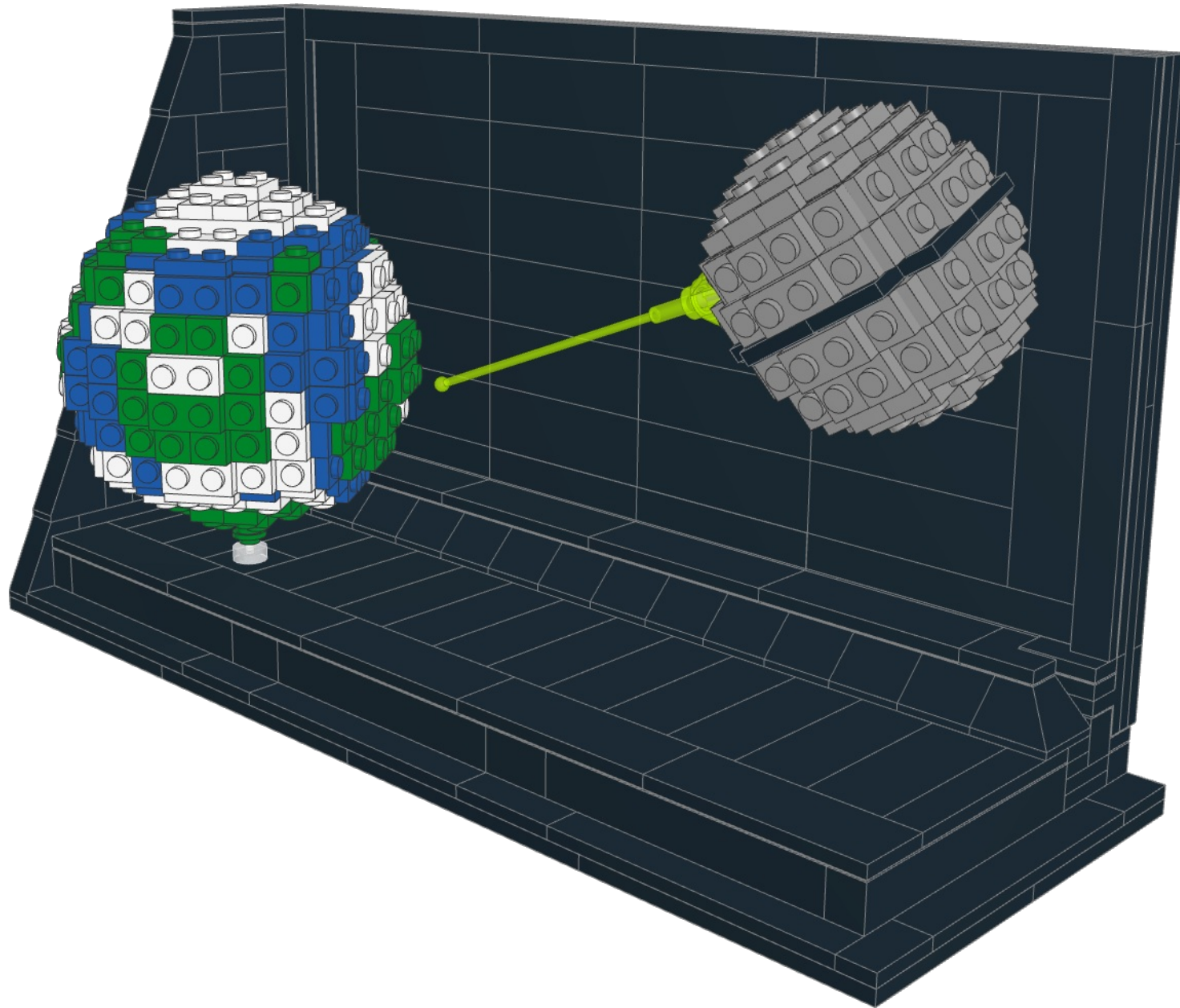

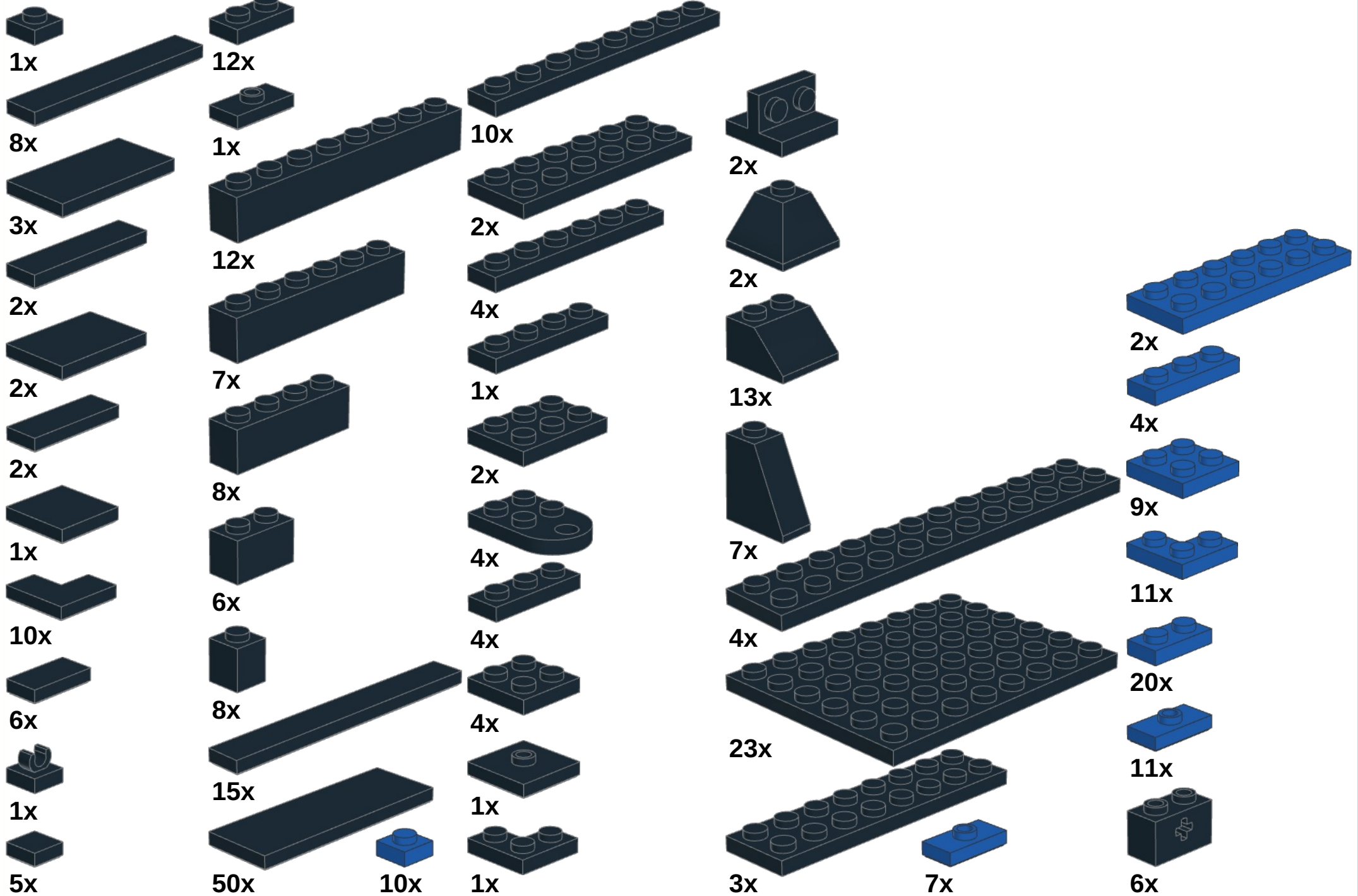



Hope you had fun with this model and instructions.
As always you can reach out to my via email:

birdbrickbuilds@gmail.com

You can also check my work on rebrickable and
instagram:

<https://rebrickable.com/users/birdbrickbuilds/>
<https://www.instagram.com/birdbrickbuilds/>

If you wish to help me continue to make this
models and instructions you can buy me a coffee
to help me stay up late:

<https://www.buymeacoffee.com/birdbrickbl>



This work is licensed under a [Creative Commons Attribution-NonCommercial-ShareAlike 4.0 International License](https://creativecommons.org/licenses/by-nc-sa/4.0/).

LEGO® is a registered trademark of the LEGO Group,
which does not sponsor, endorse, or authorize these
instructions or the model they depict.

Instructions configured and generated using LPub3D 2.4.3.0.2557
Download LPub3D at <https://trevorsandy.github.io/lpub3d/>

