

BDN in Lego

Model instructions by Eduardo Sousa



510 Parts

BDN Architectural company logo with the human doll on the side.

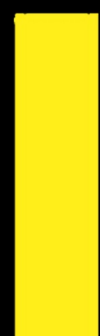



Attribution-NonCommercial-ShareAlike 4.0 International (CC BY-NC-SA 4.0)

This is a human-readable summary of (and not a substitute for) the [license](#). [Disclaimer](#).

You are free to:

Share — copy and redistribute the material in any medium or format

Adapt — remix, transform, and build upon the material

The licensor cannot revoke these freedoms as long as you follow the license terms.

Under the following terms:



Attribution — You must give [appropriate credit](#), provide a link to the license, and [indicate if changes were made](#). You may do so in any reasonable manner, but not in any way that suggests the licensor endorses you or your use.



NonCommercial — You may not use the material for [commercial purposes](#).



ShareAlike — If you remix, transform, or build upon the material, you must distribute your contributions under the [same license](#) as the original.

No additional restrictions — You may not apply legal terms or [technological measures](#) that legally restrict others from doing anything the license permits.

Notices:

You do not have to comply with the license for elements of the material in the public domain or where your use is permitted by an applicable [exception or limitation](#).

No warranties are given. The license may not give you all of the permissions necessary for your intended use. For example, other rights such as [publicity, privacy, or moral rights](#) may limit how you use the material.

1

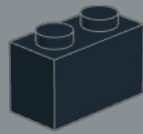
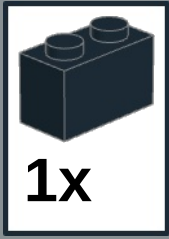

2

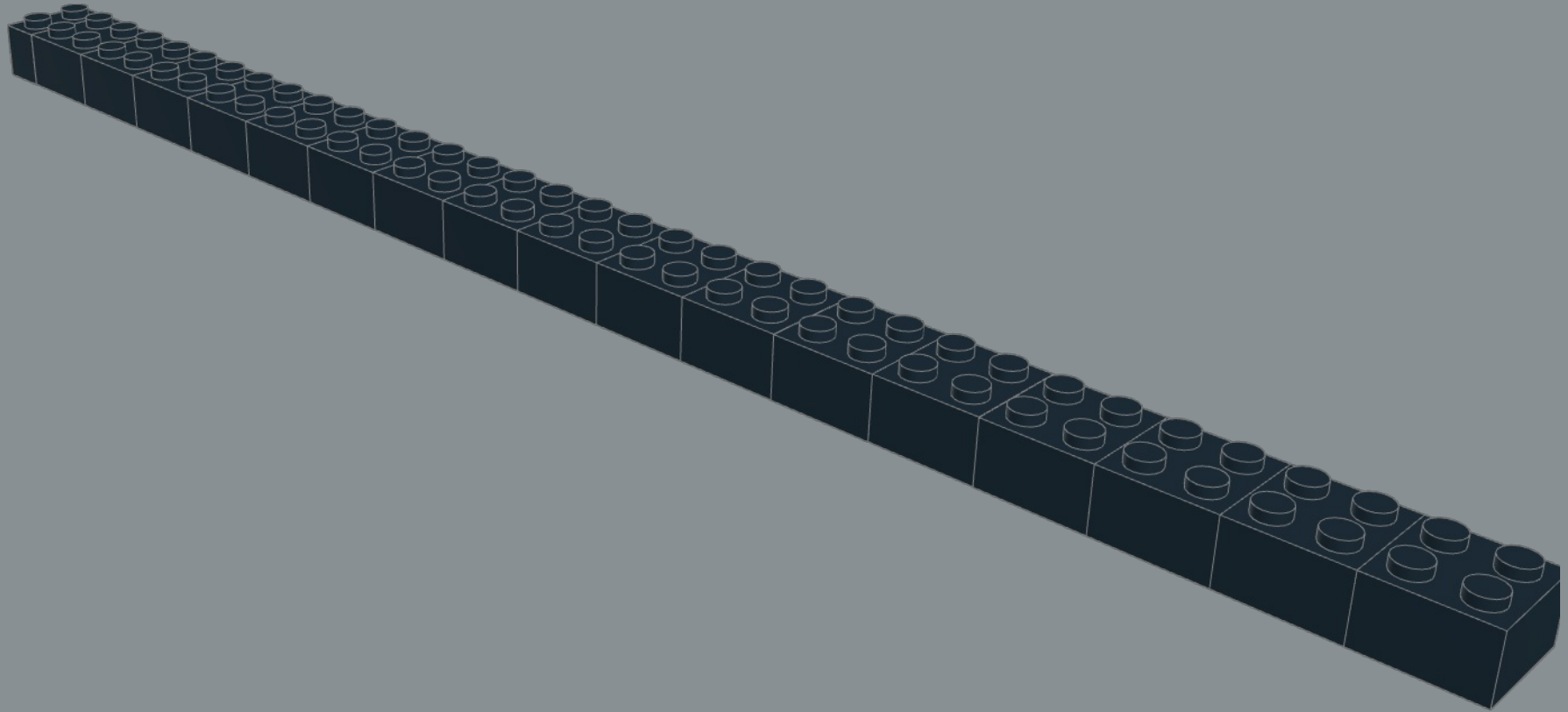
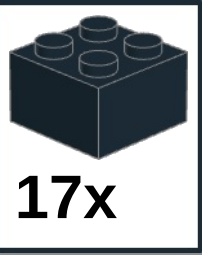

3

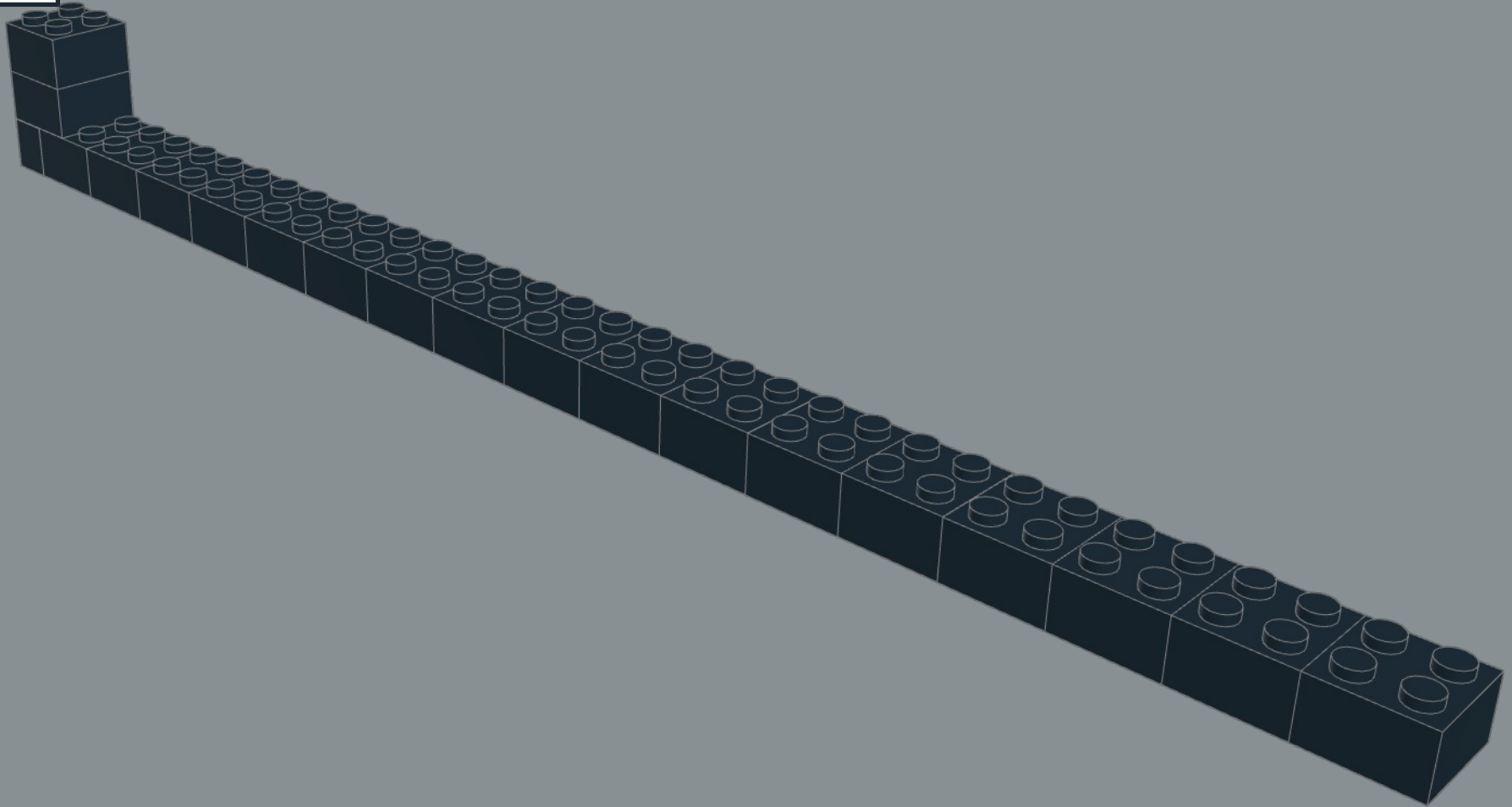
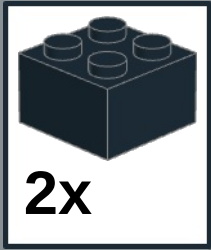

4

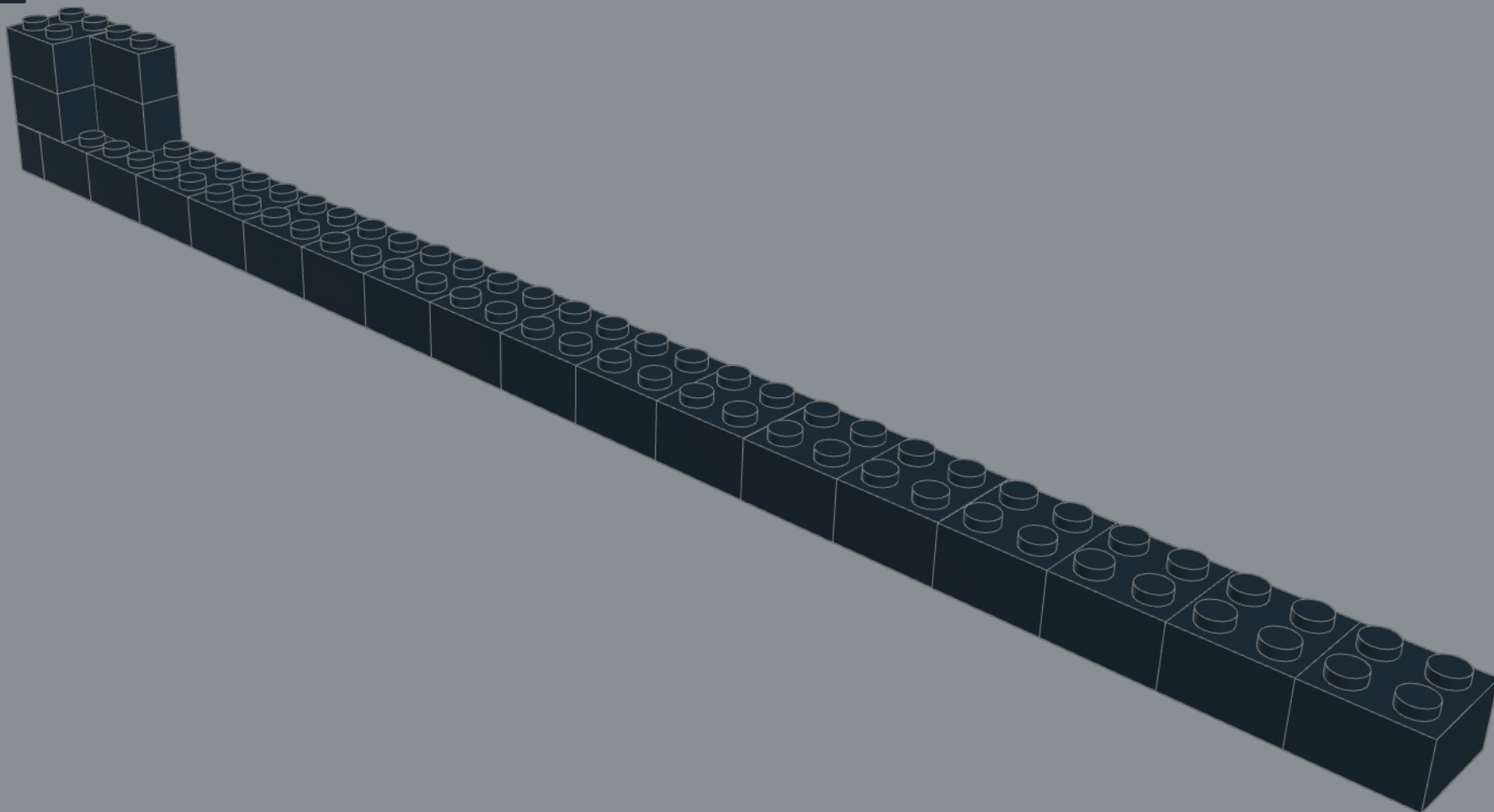
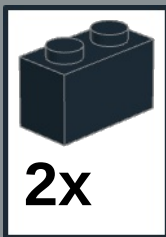

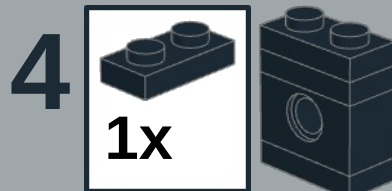
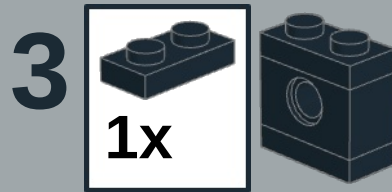
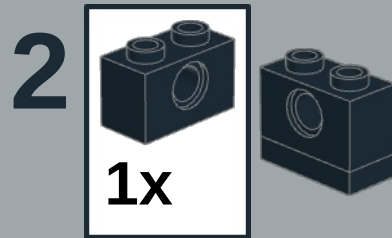
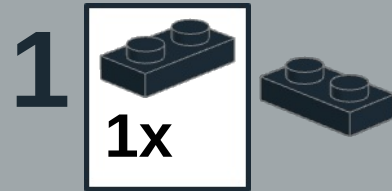

x6

5

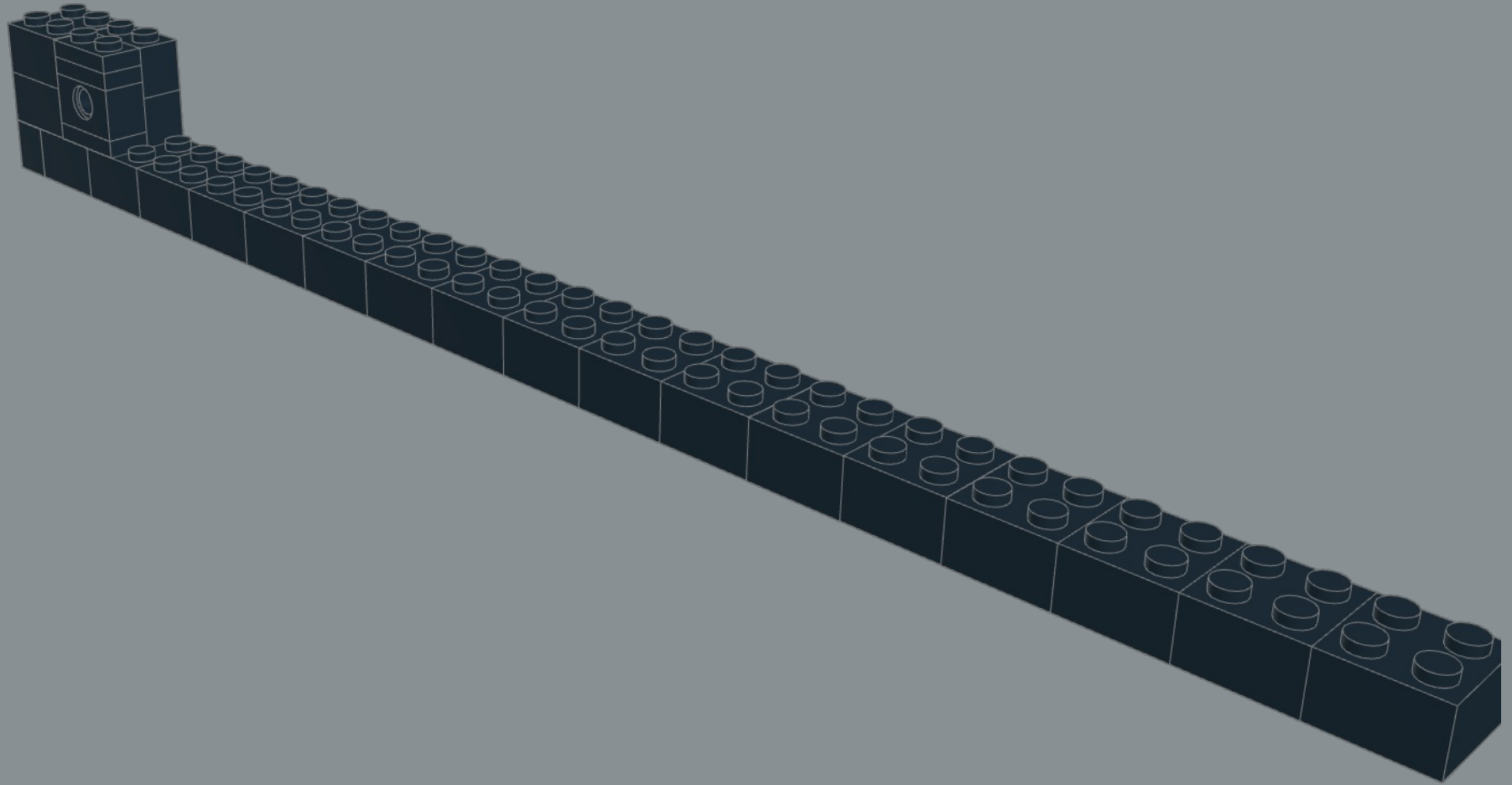

6

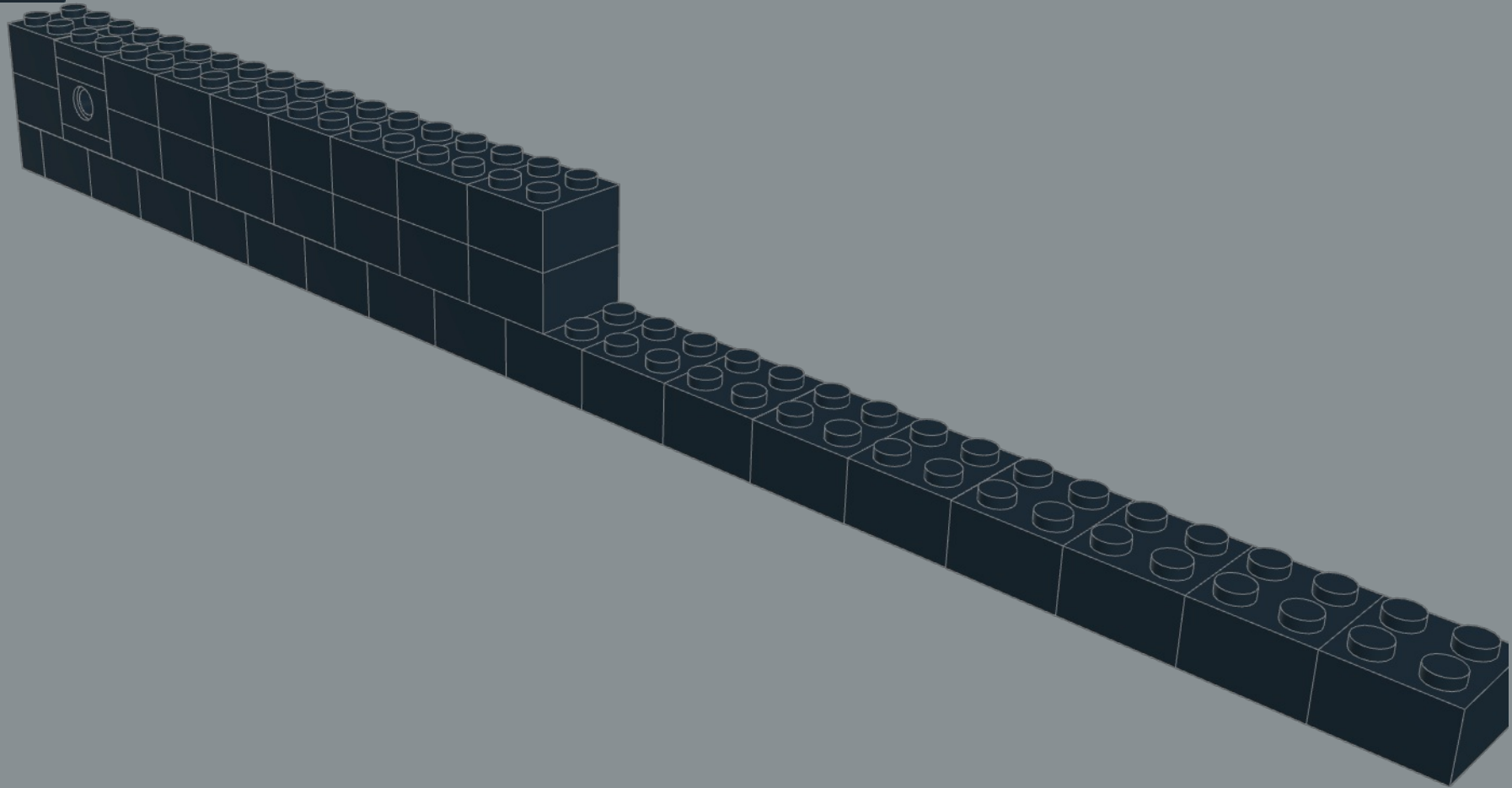
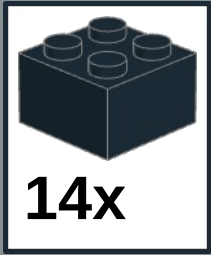

7

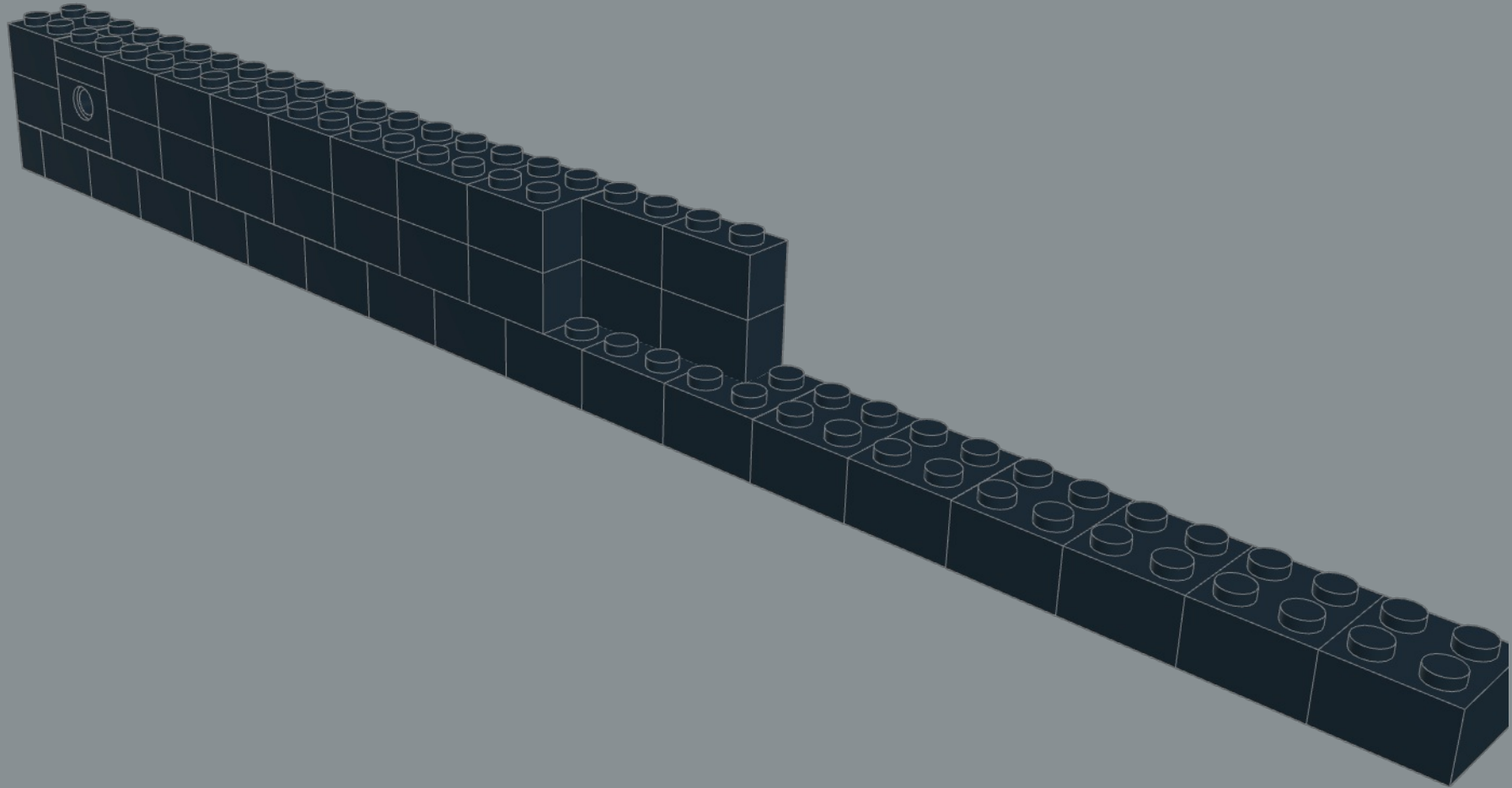
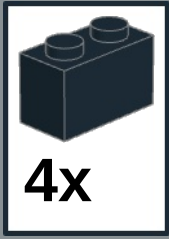

8

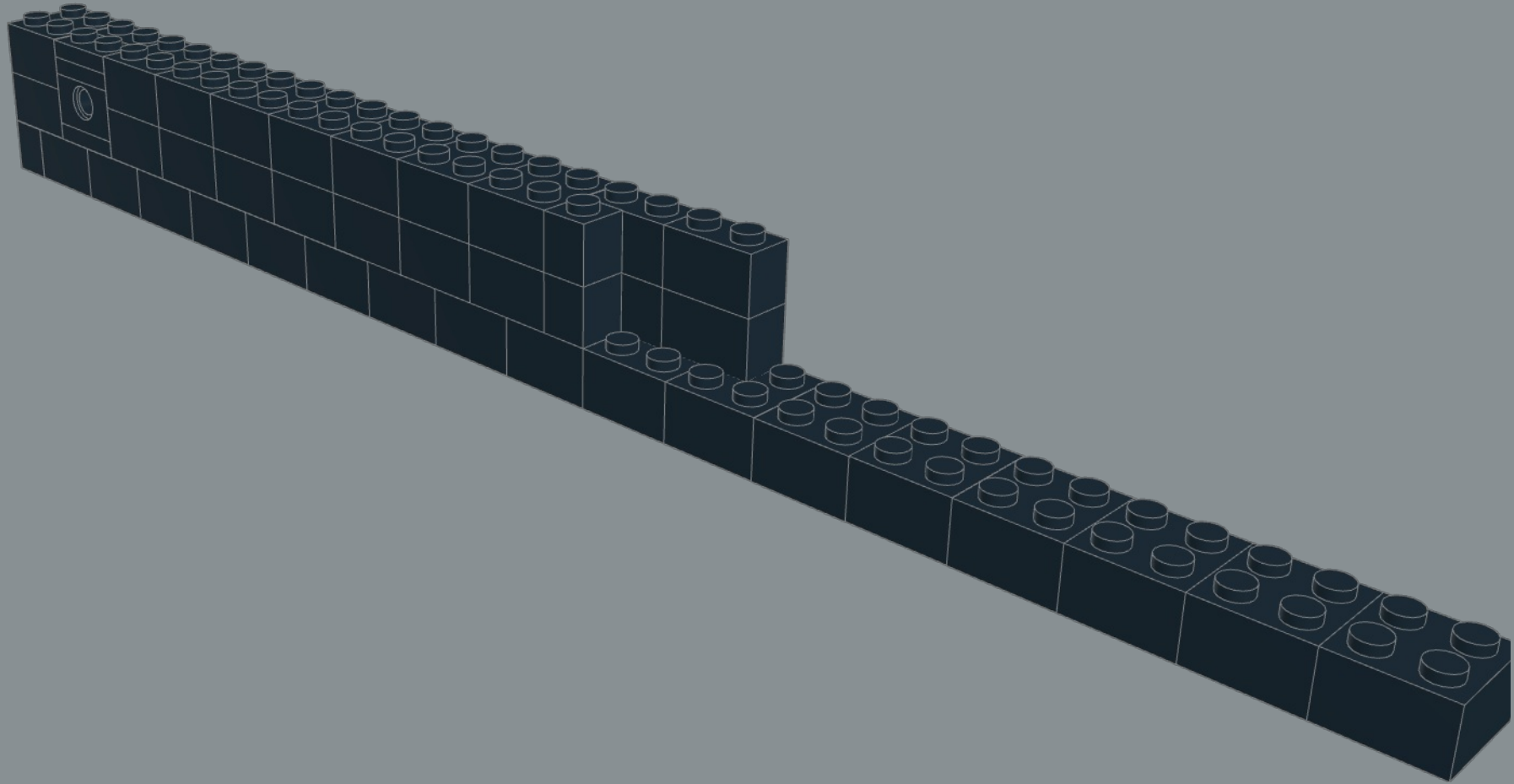

9

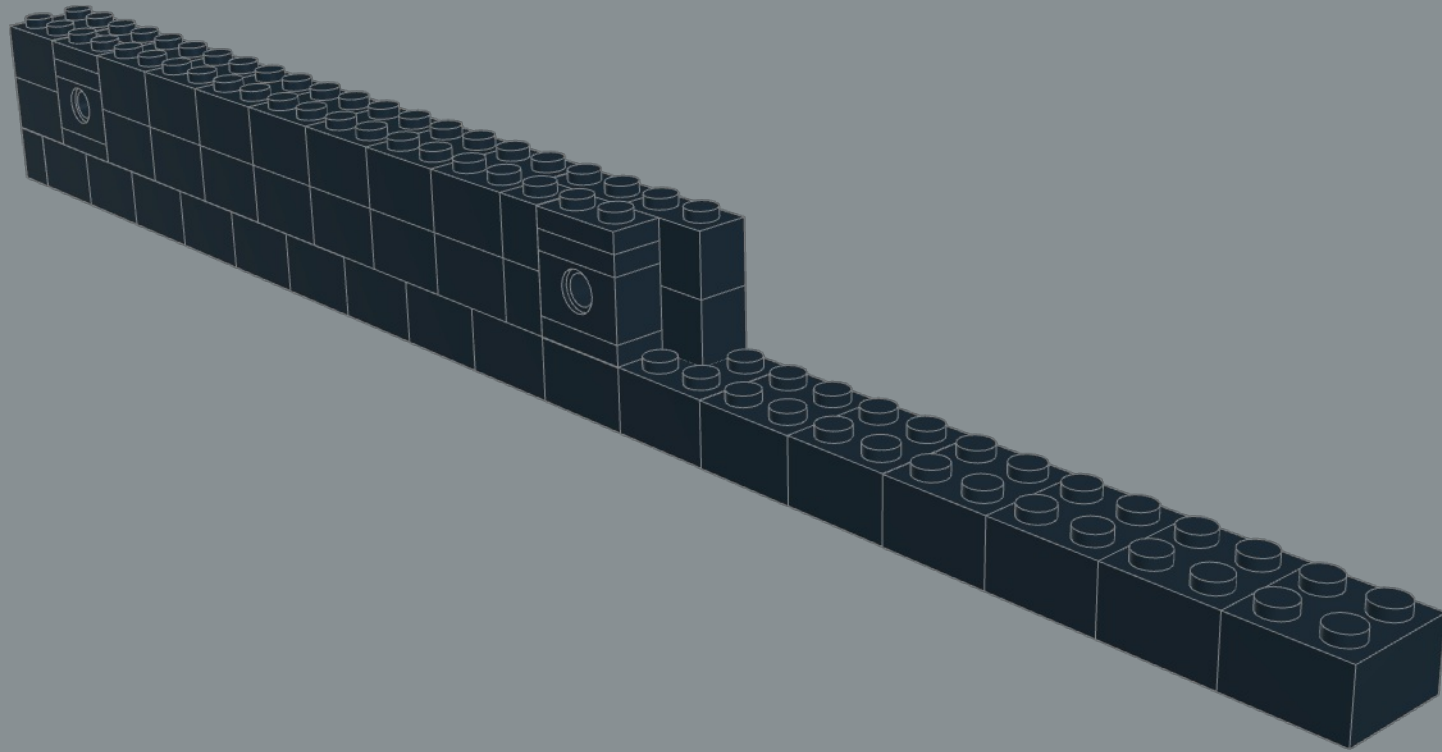

10

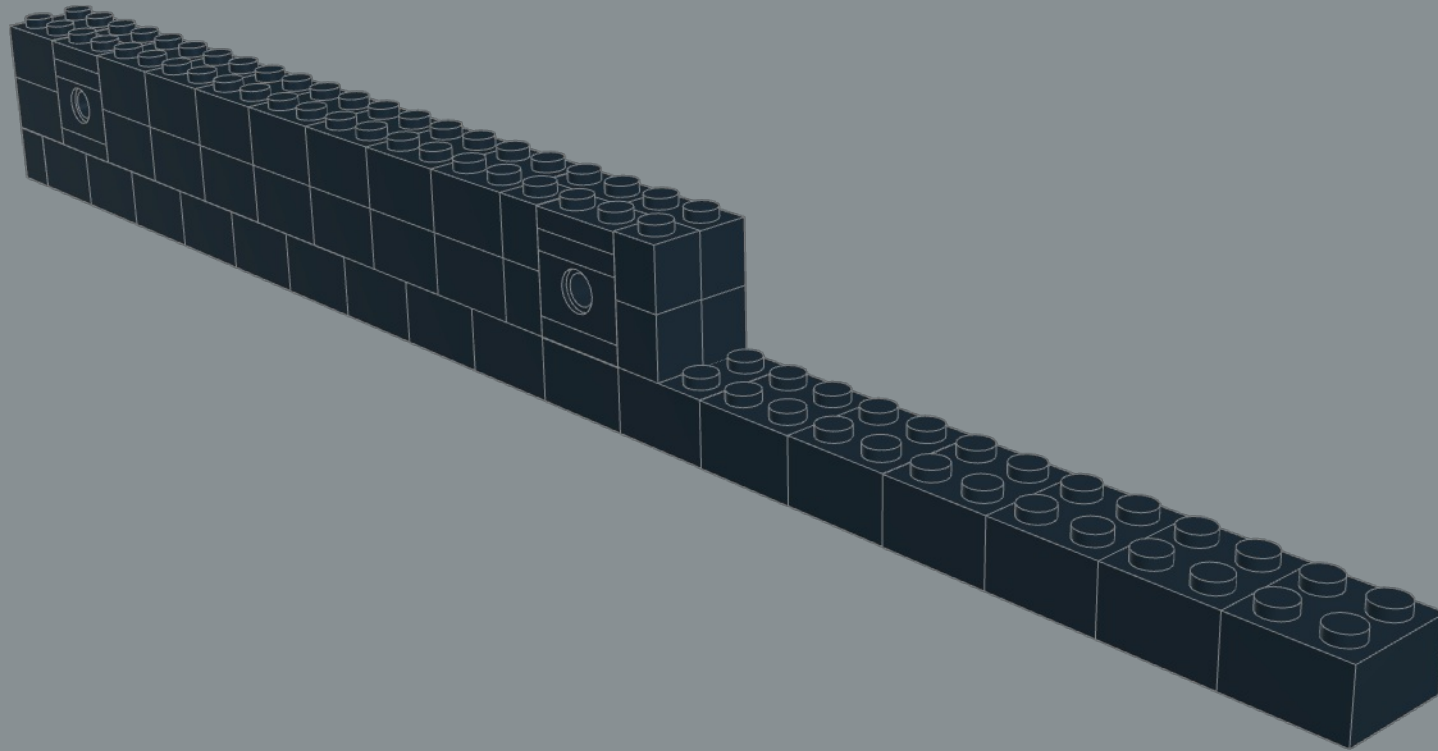

11

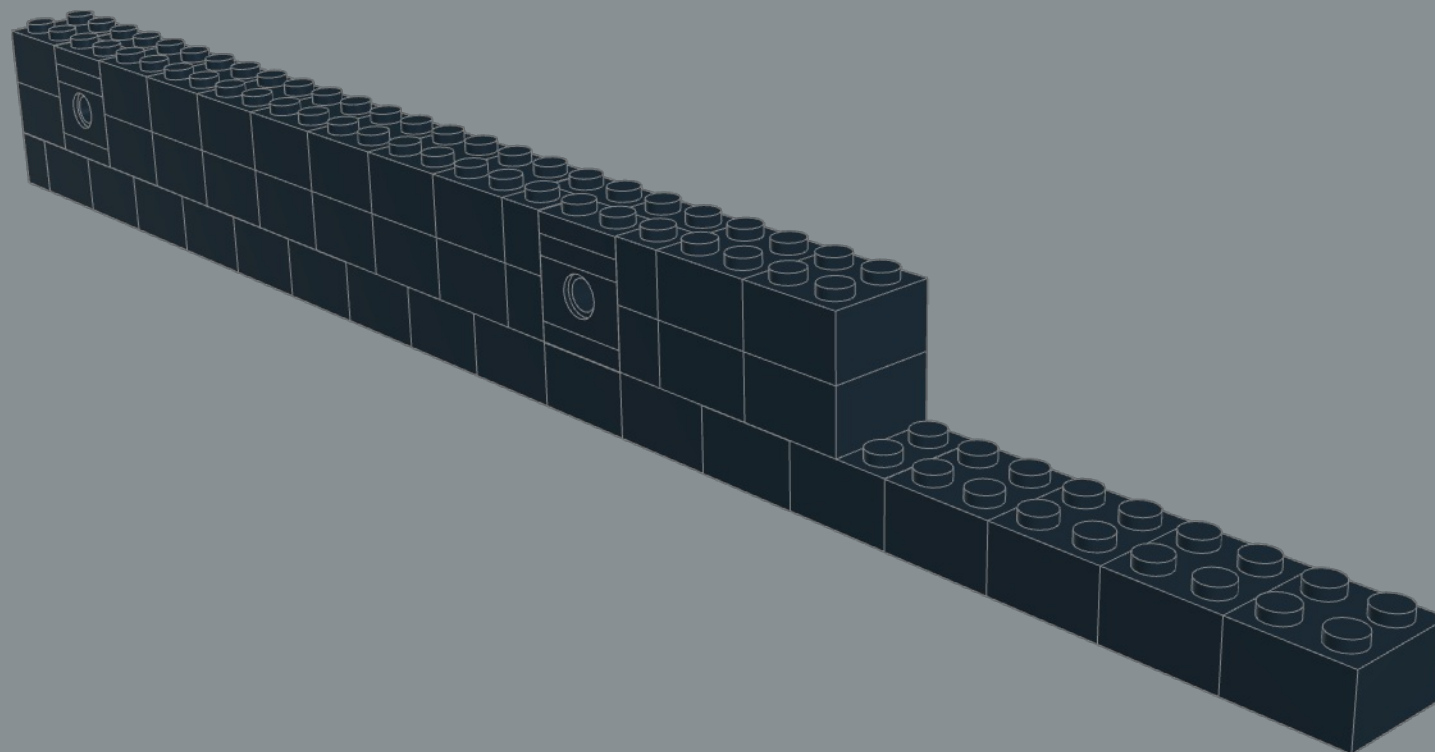
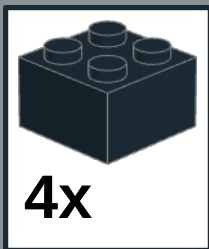

12

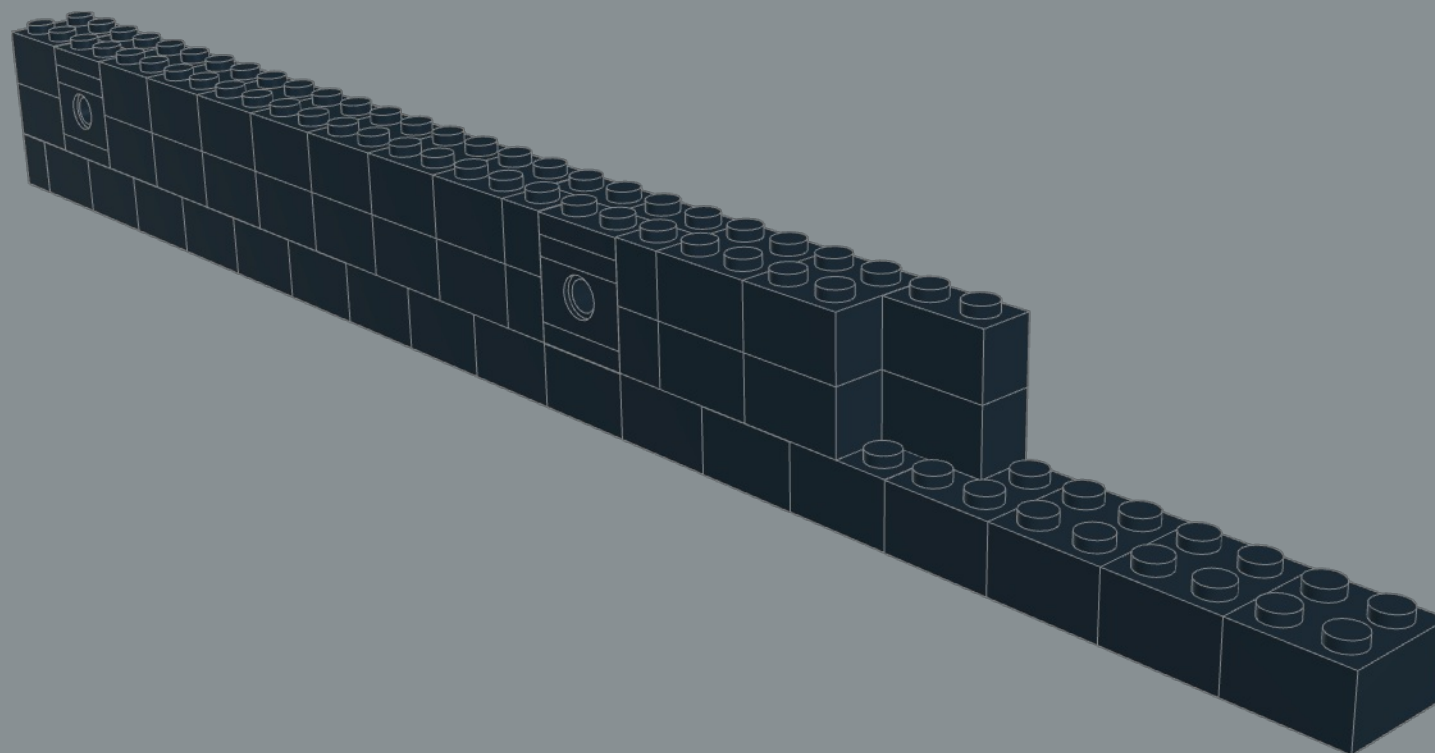
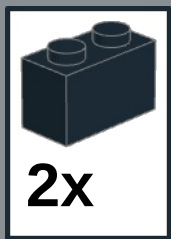

14

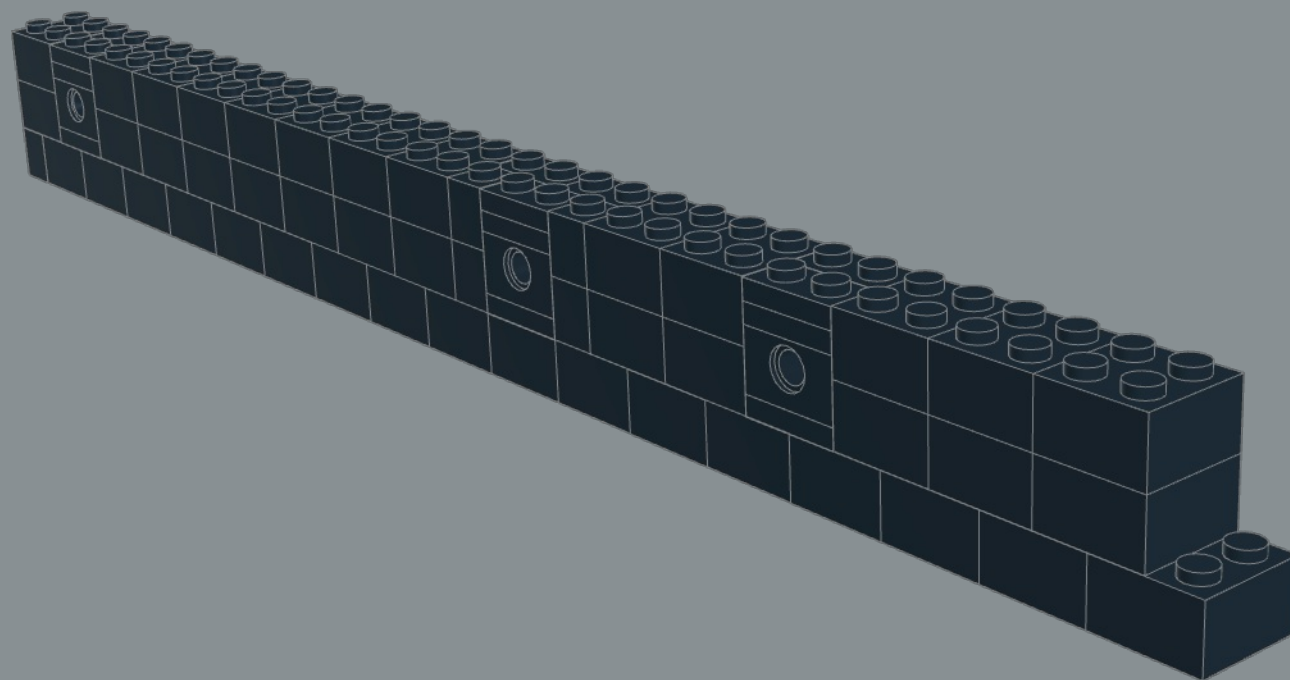
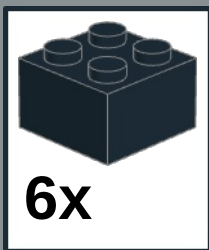

15

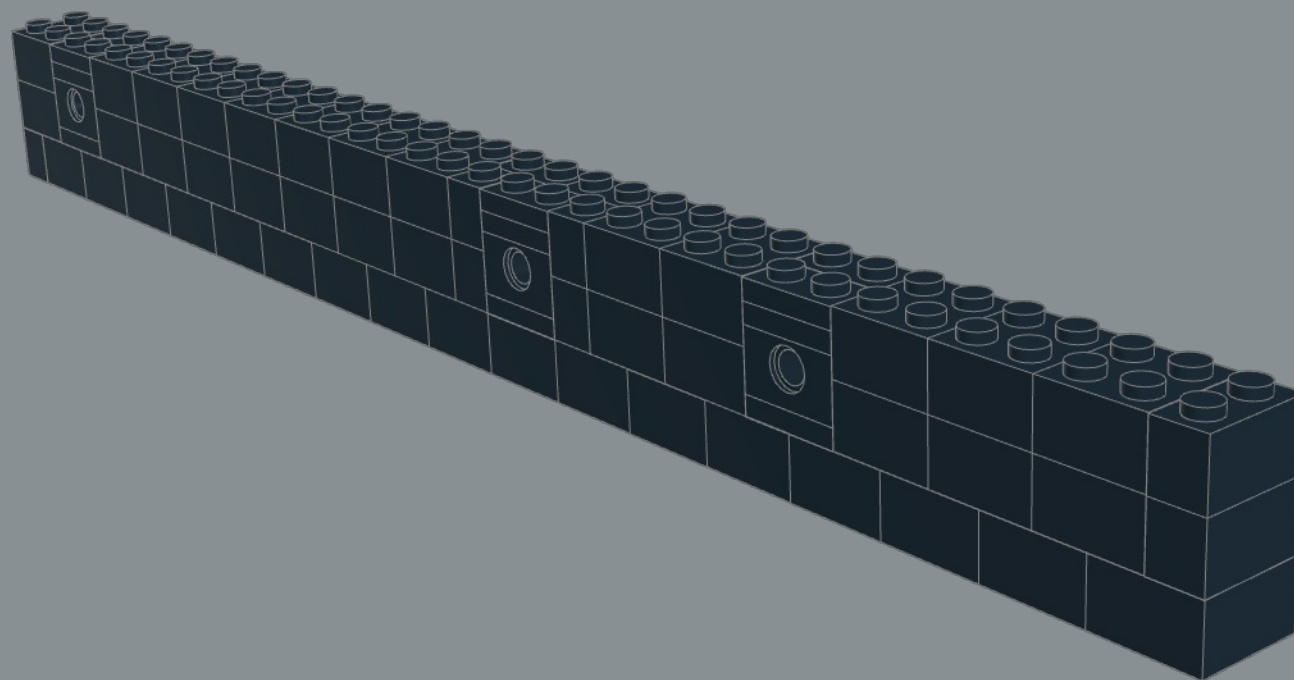
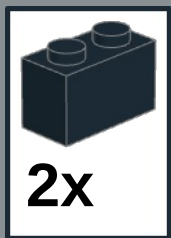

16

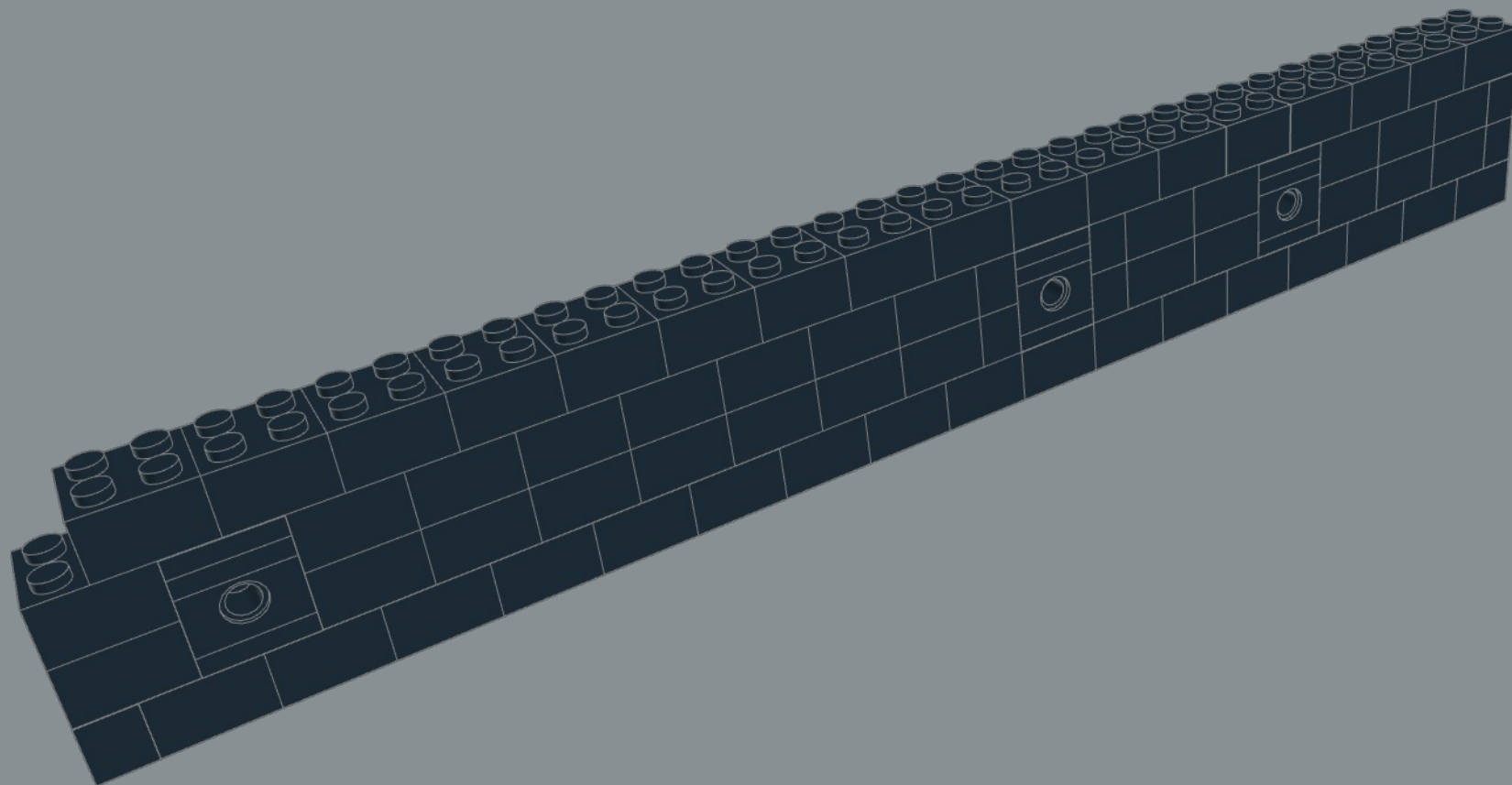
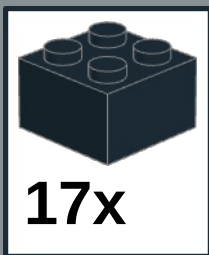

17

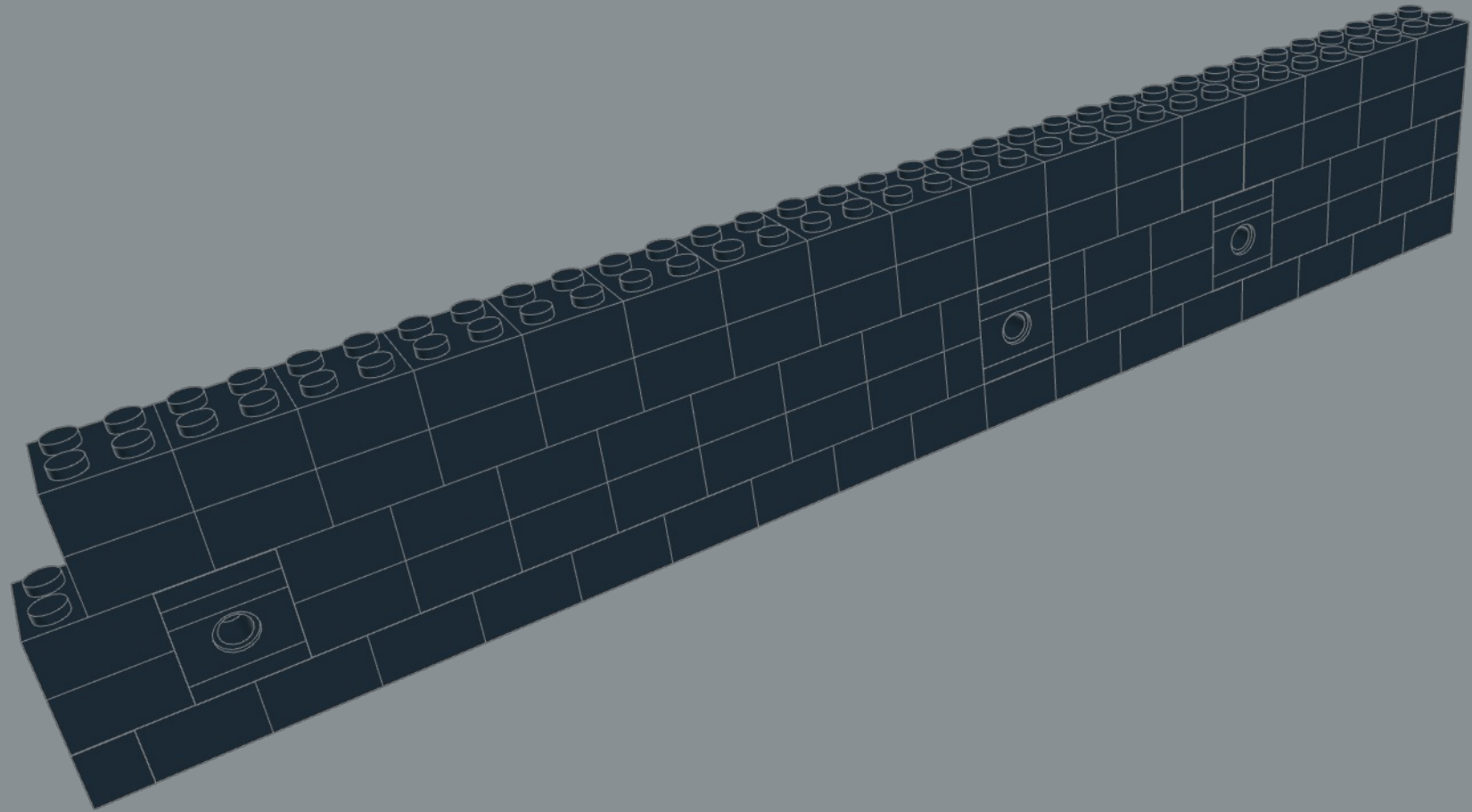
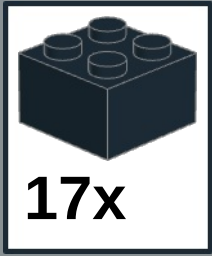

18

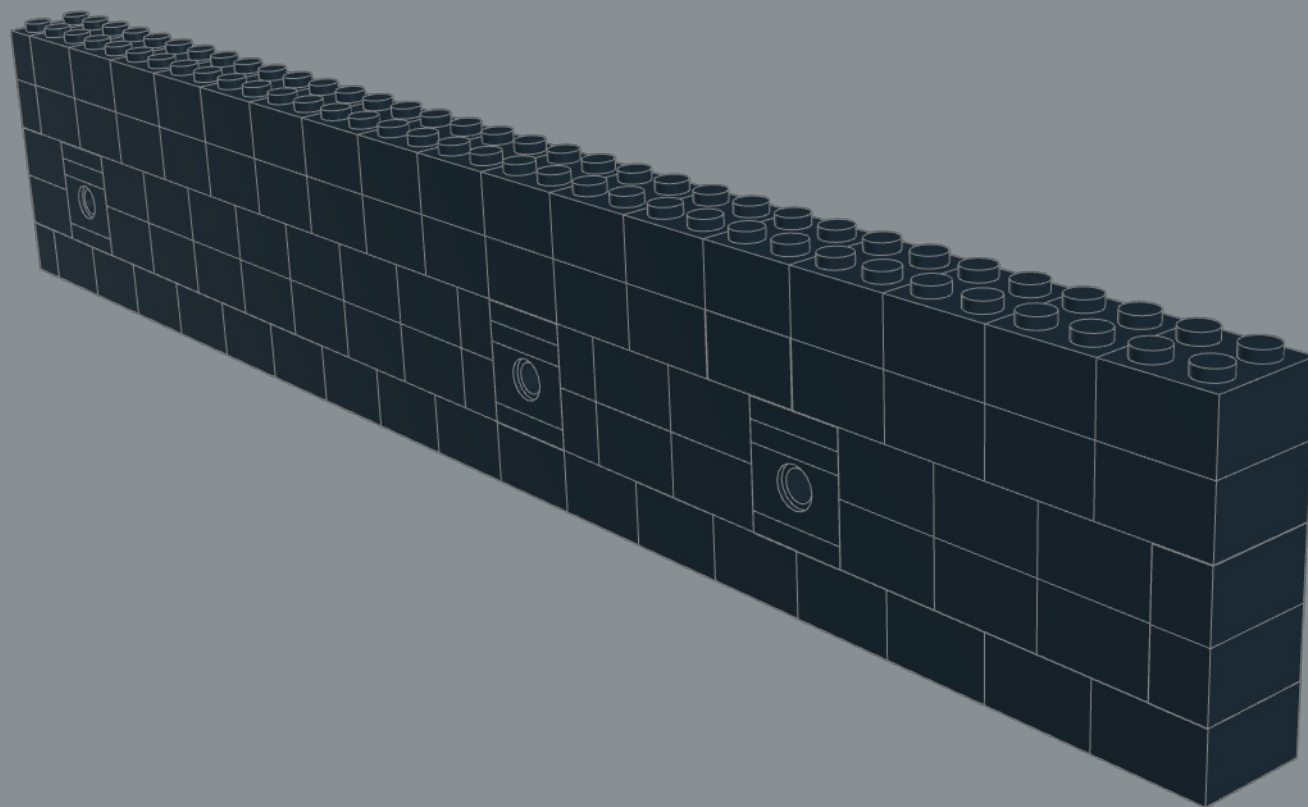
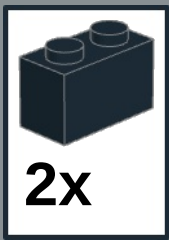

19

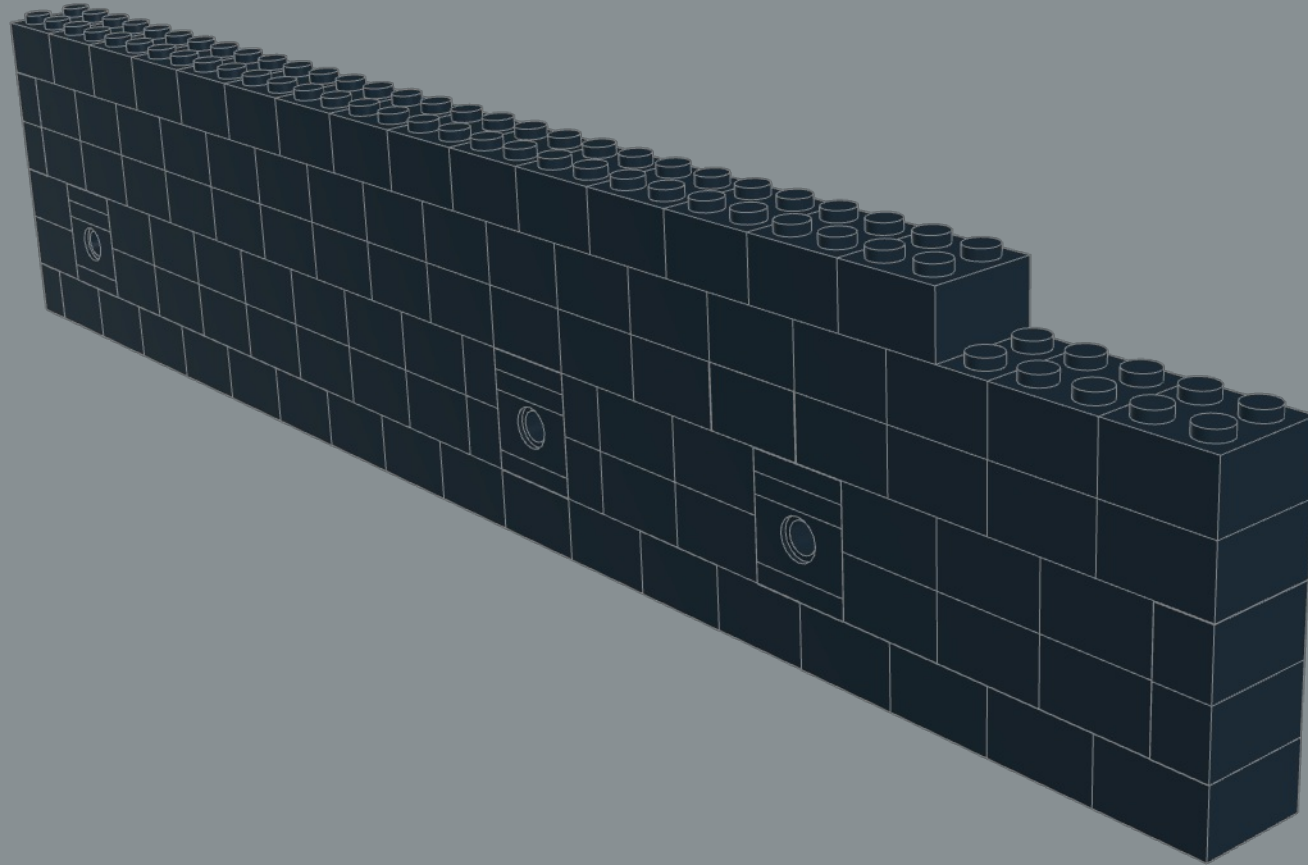
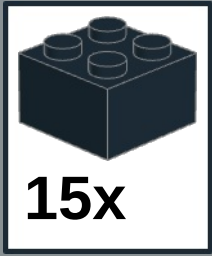

20

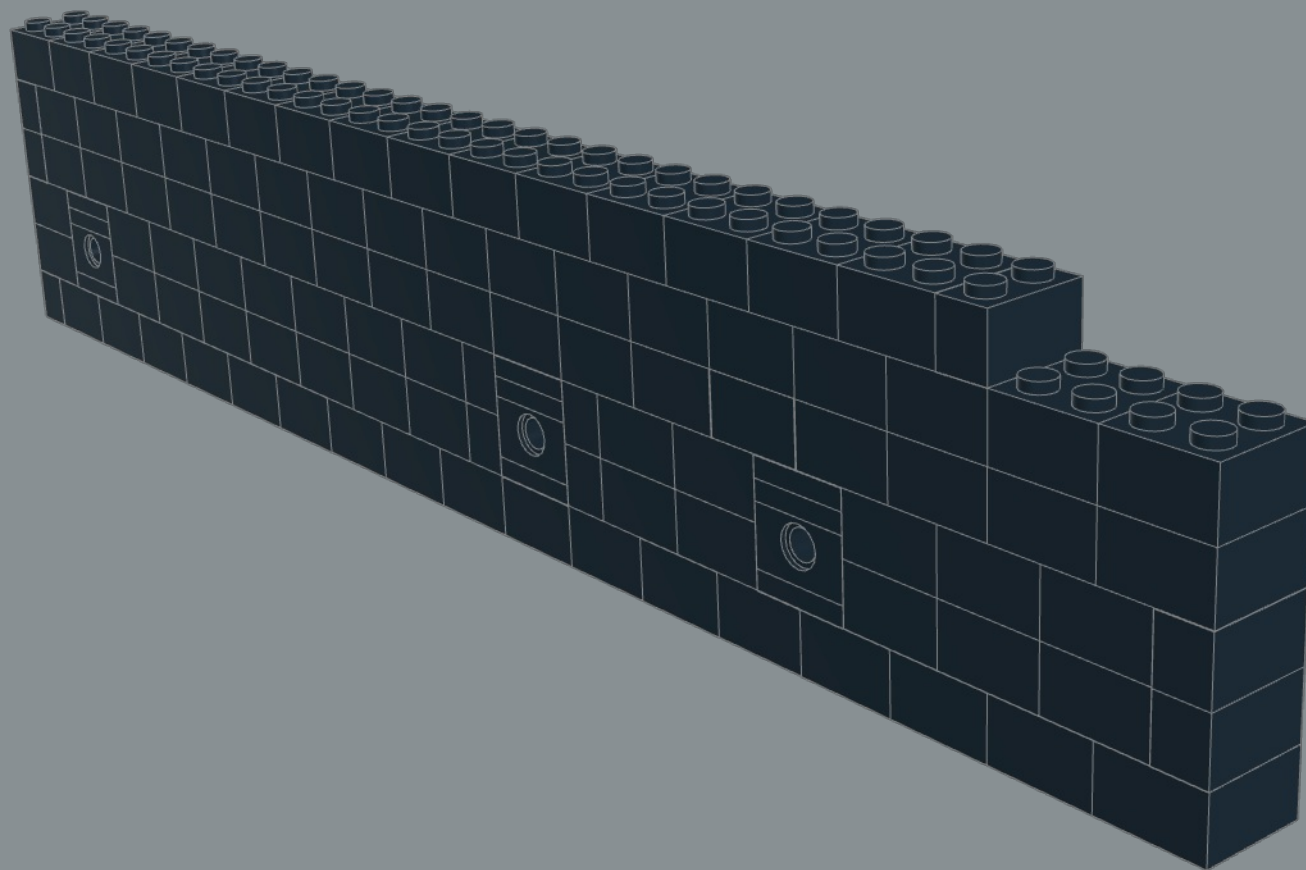
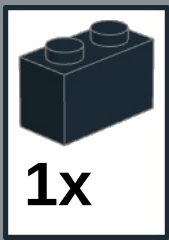

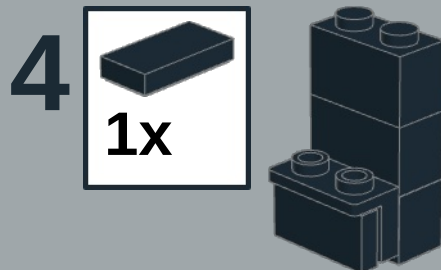
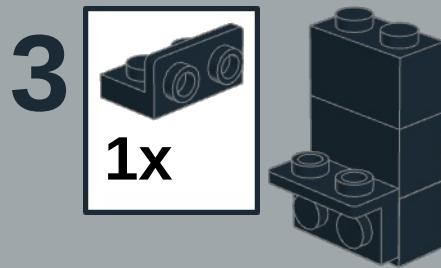
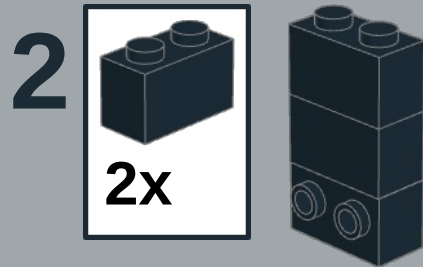
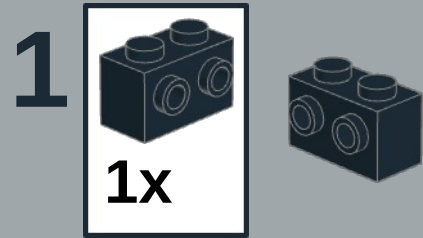

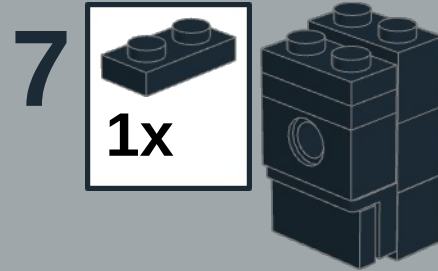
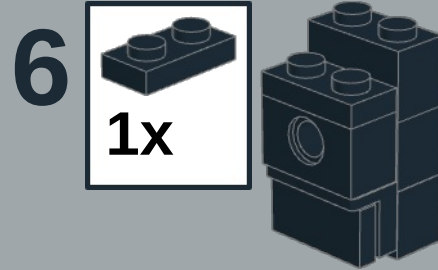
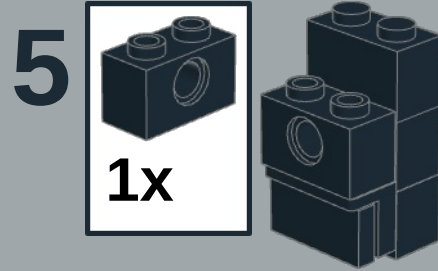

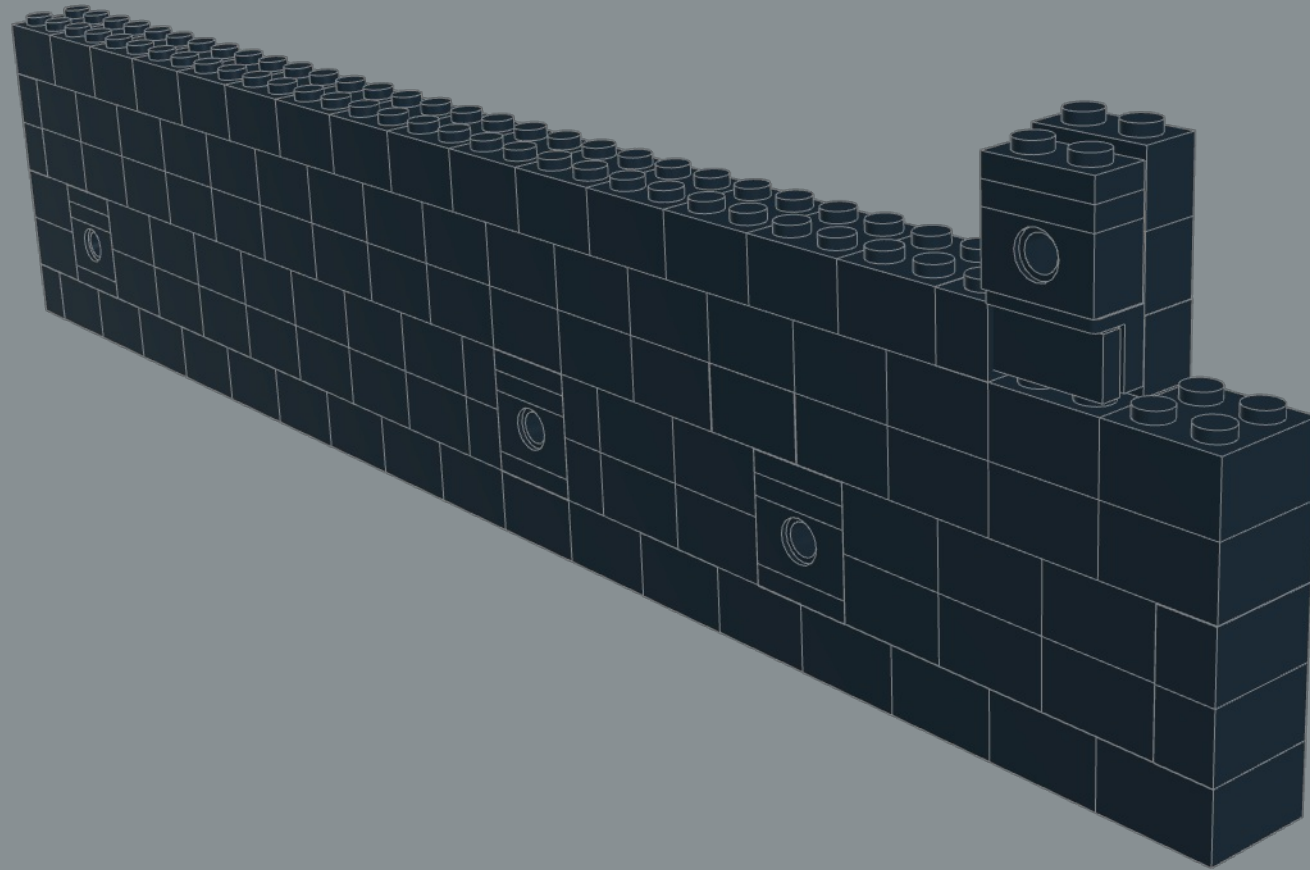

22

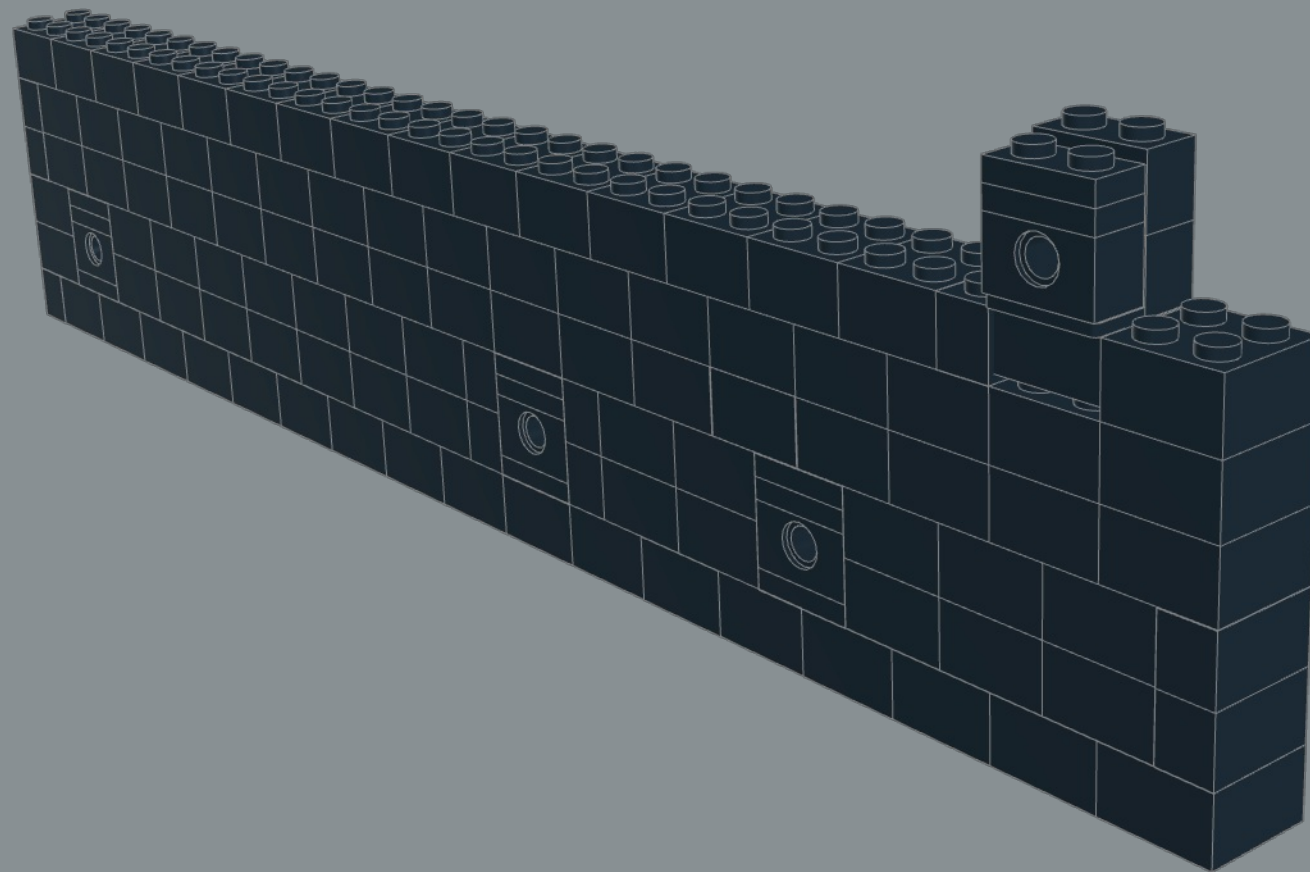
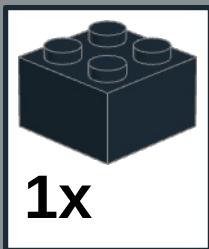

23

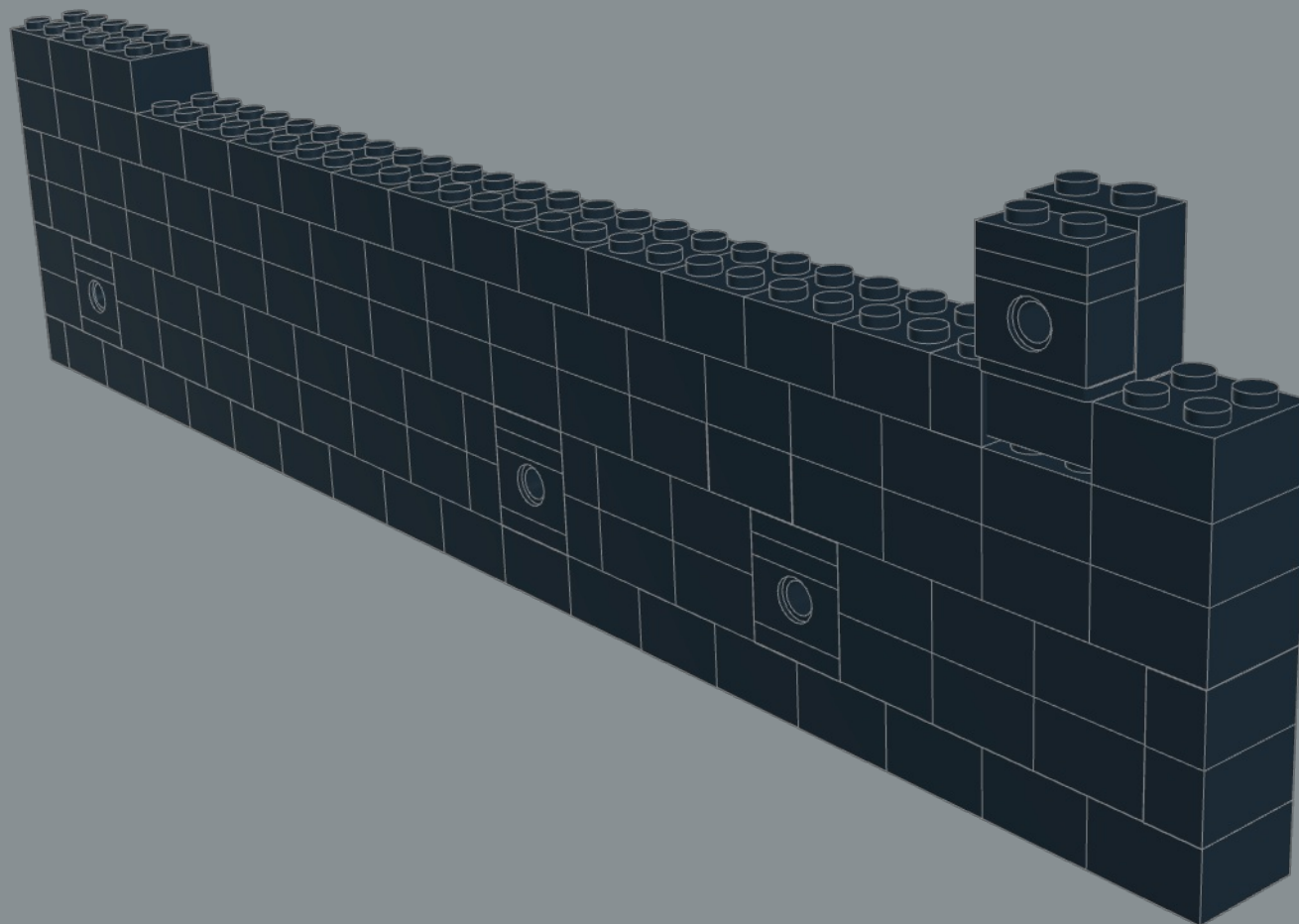
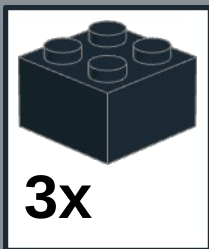

24

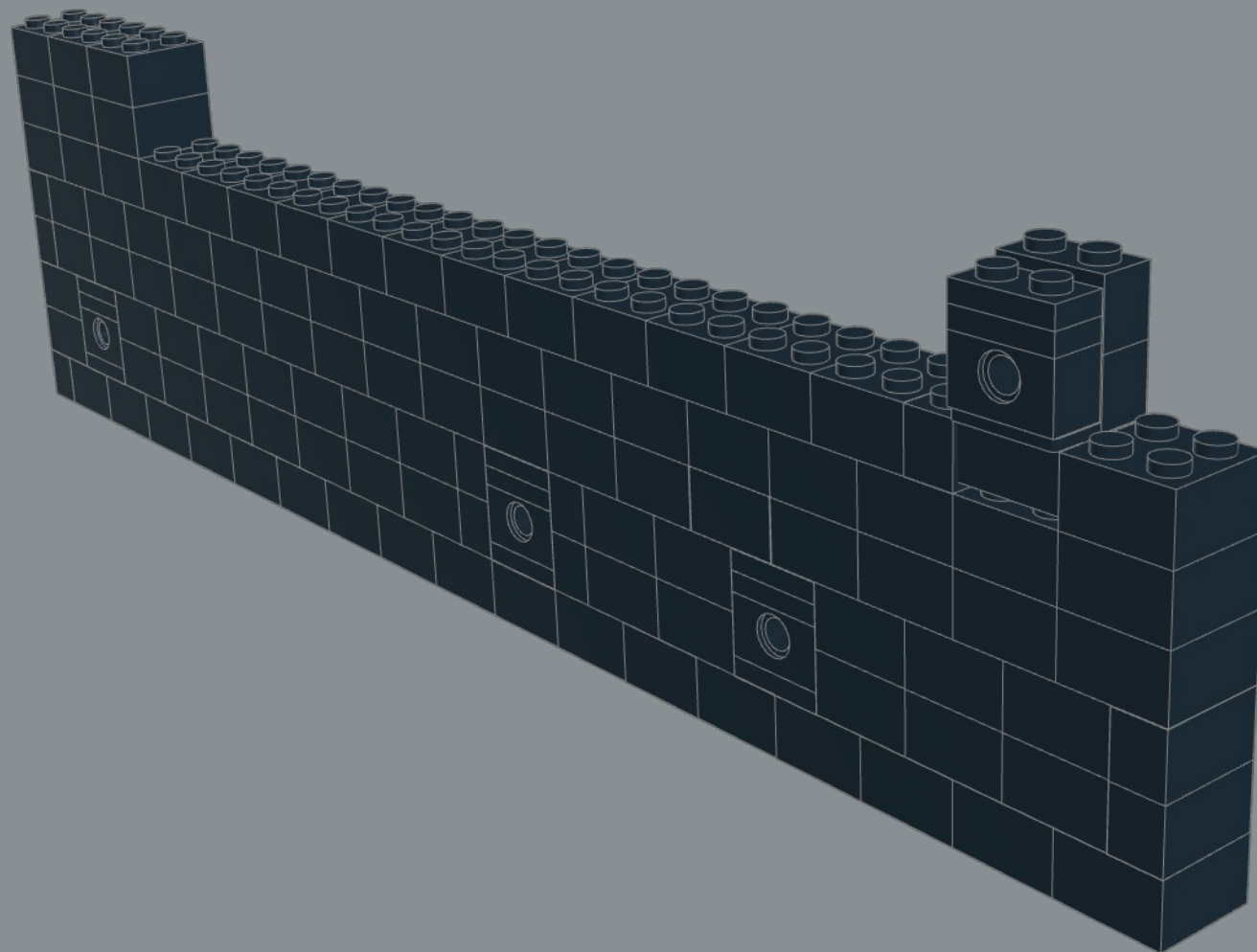
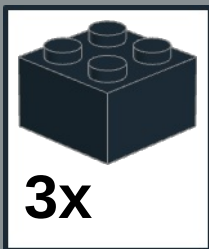

25

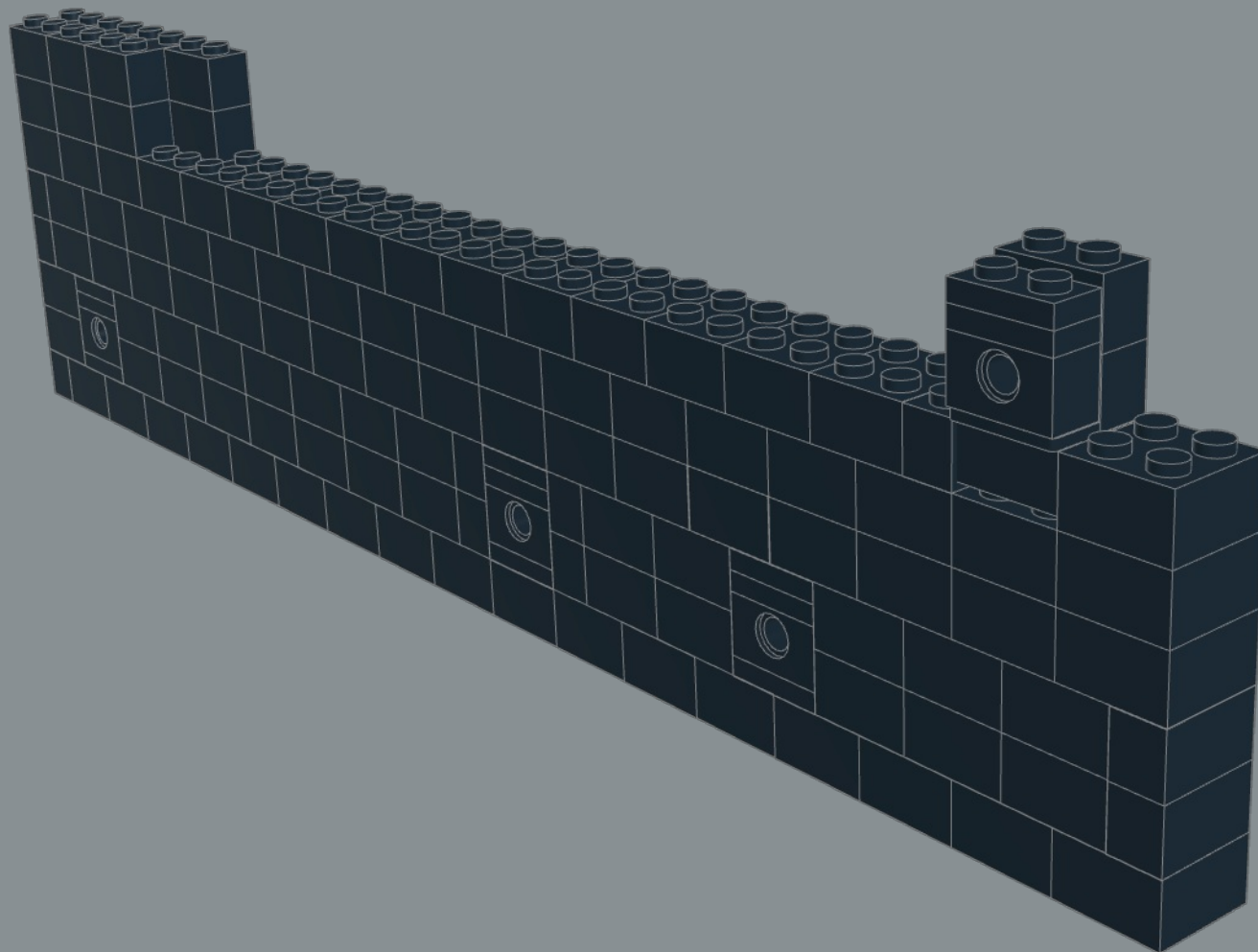
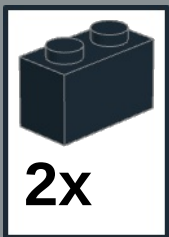

26

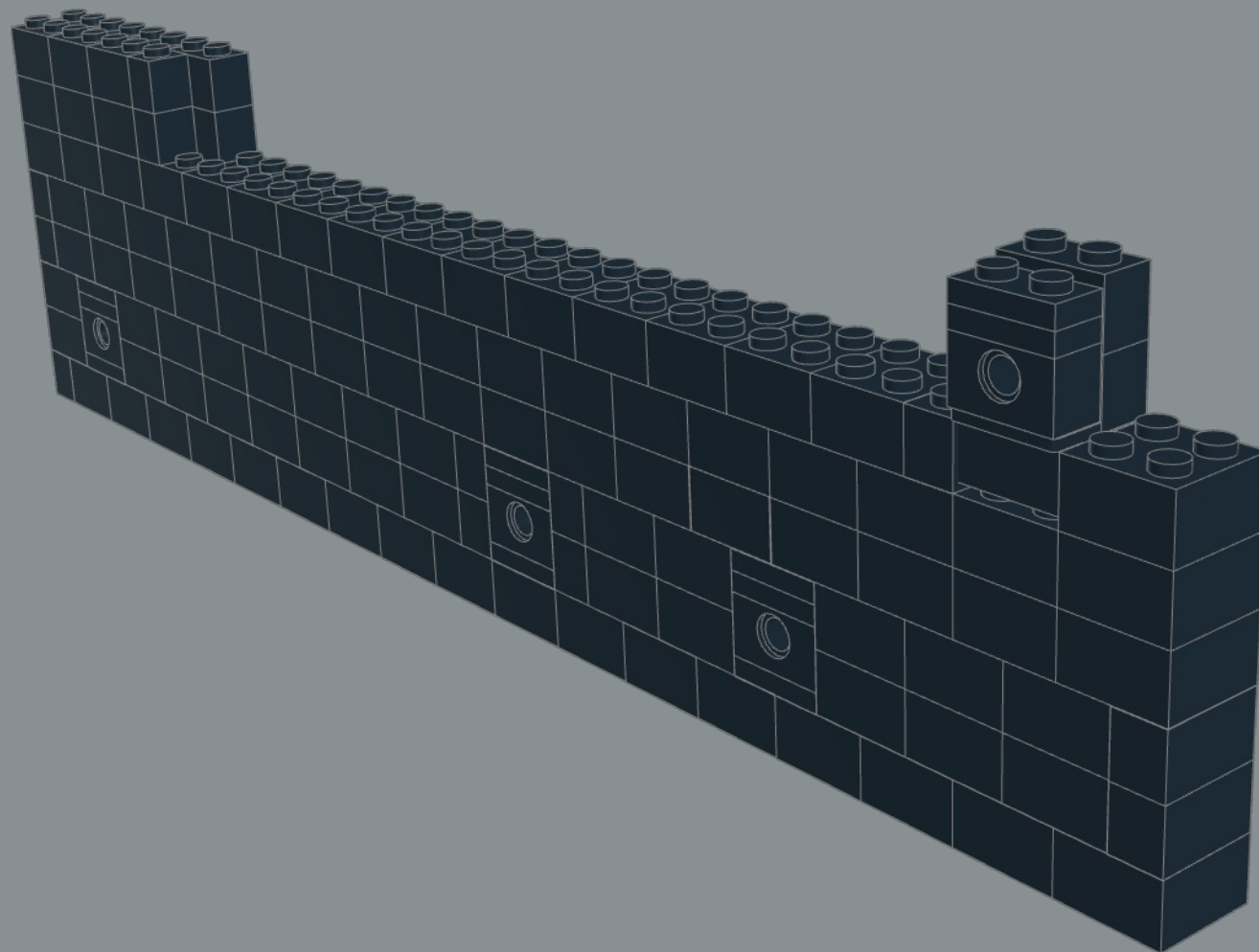

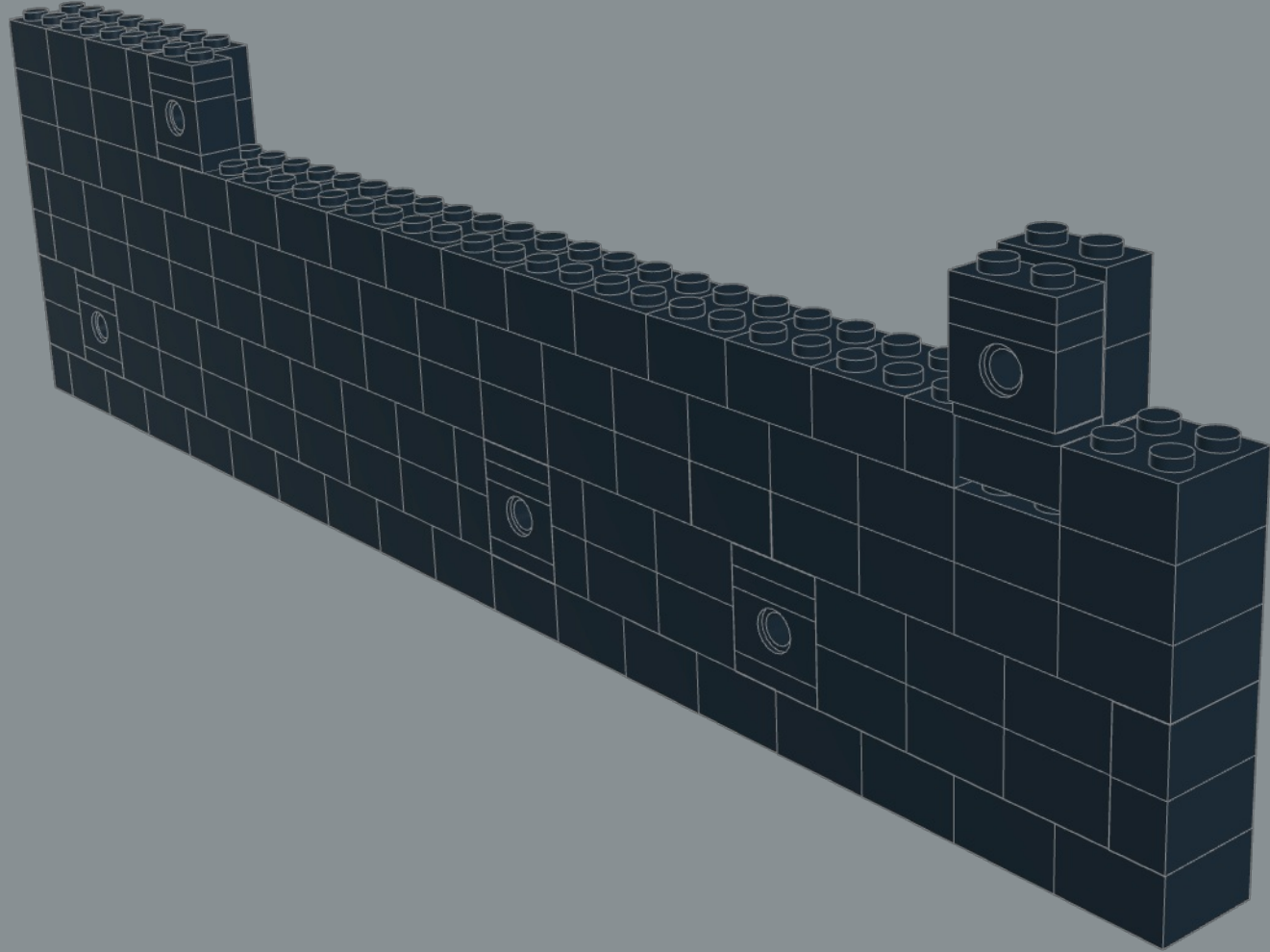

28

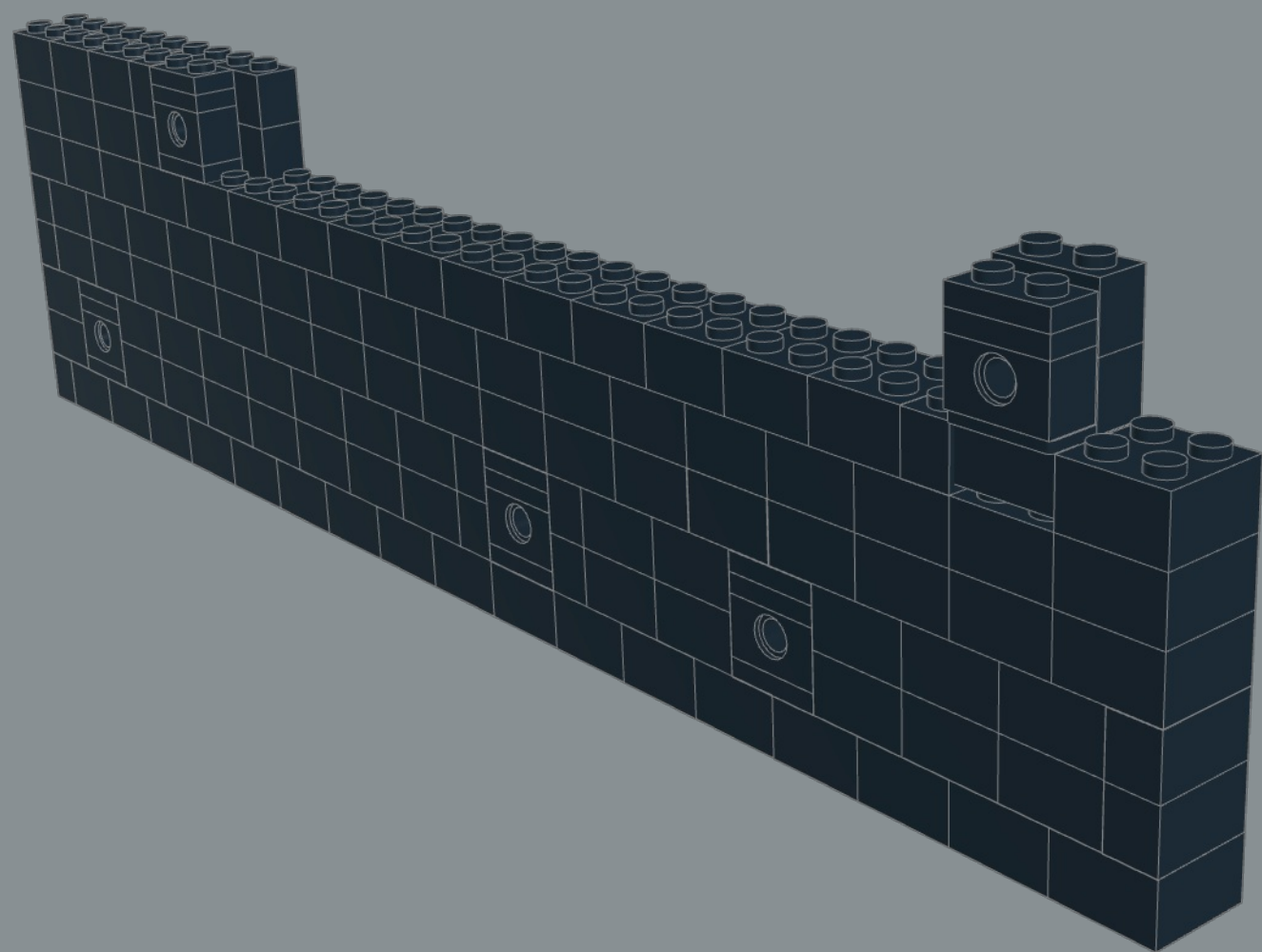
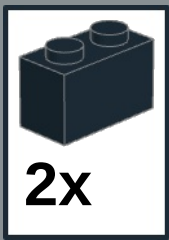

29

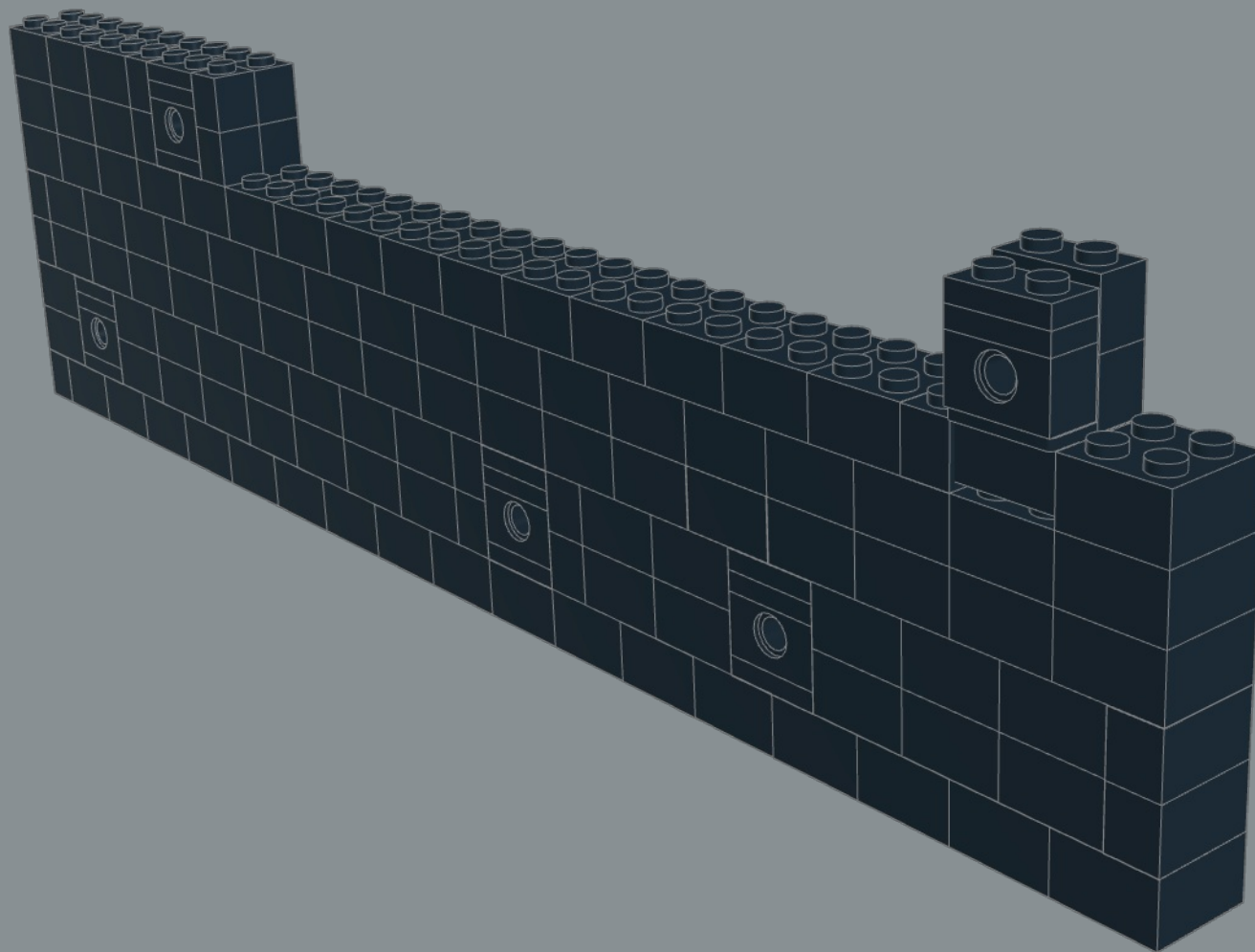

30

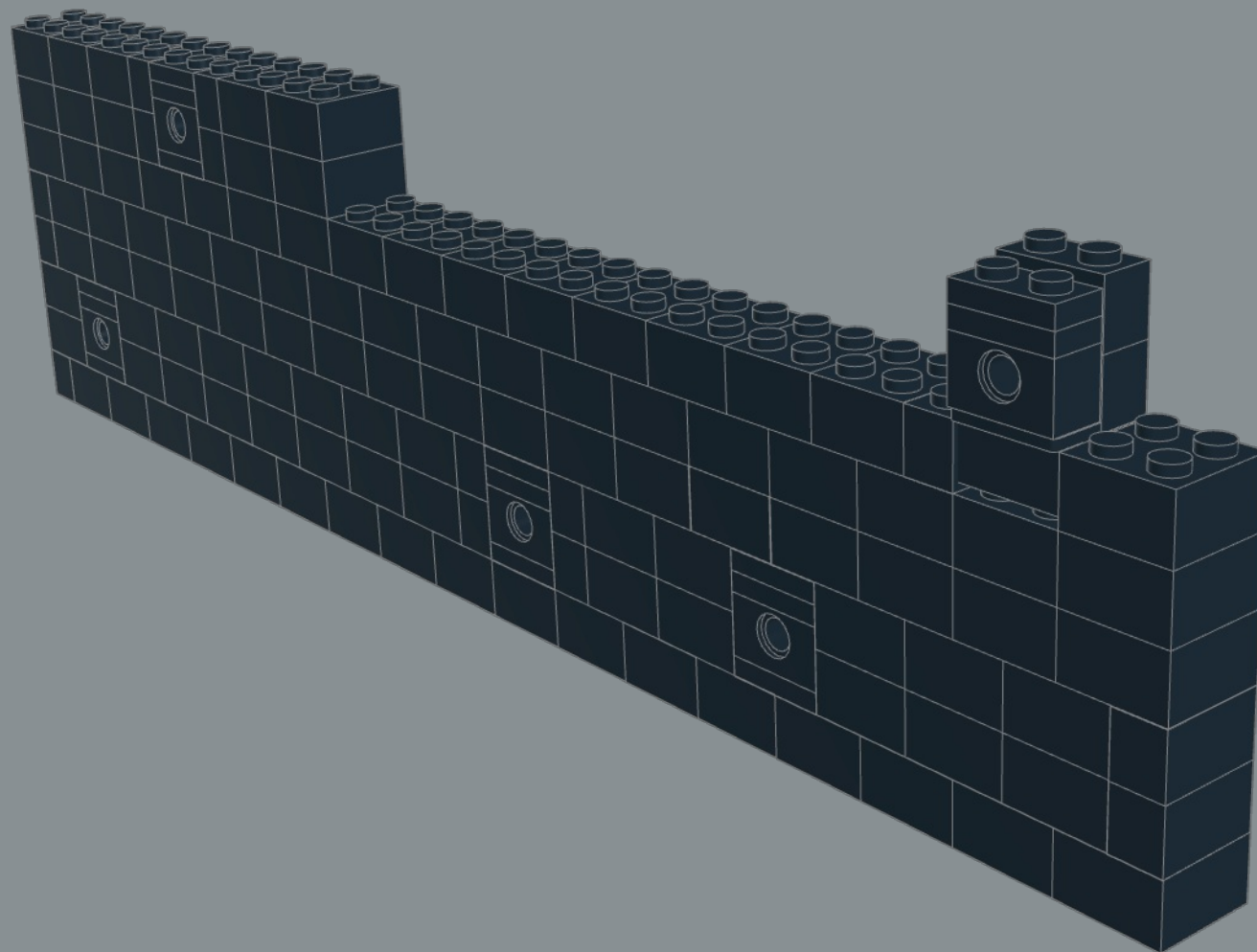
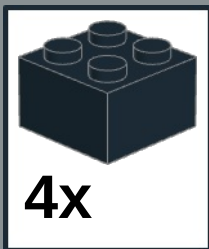

31

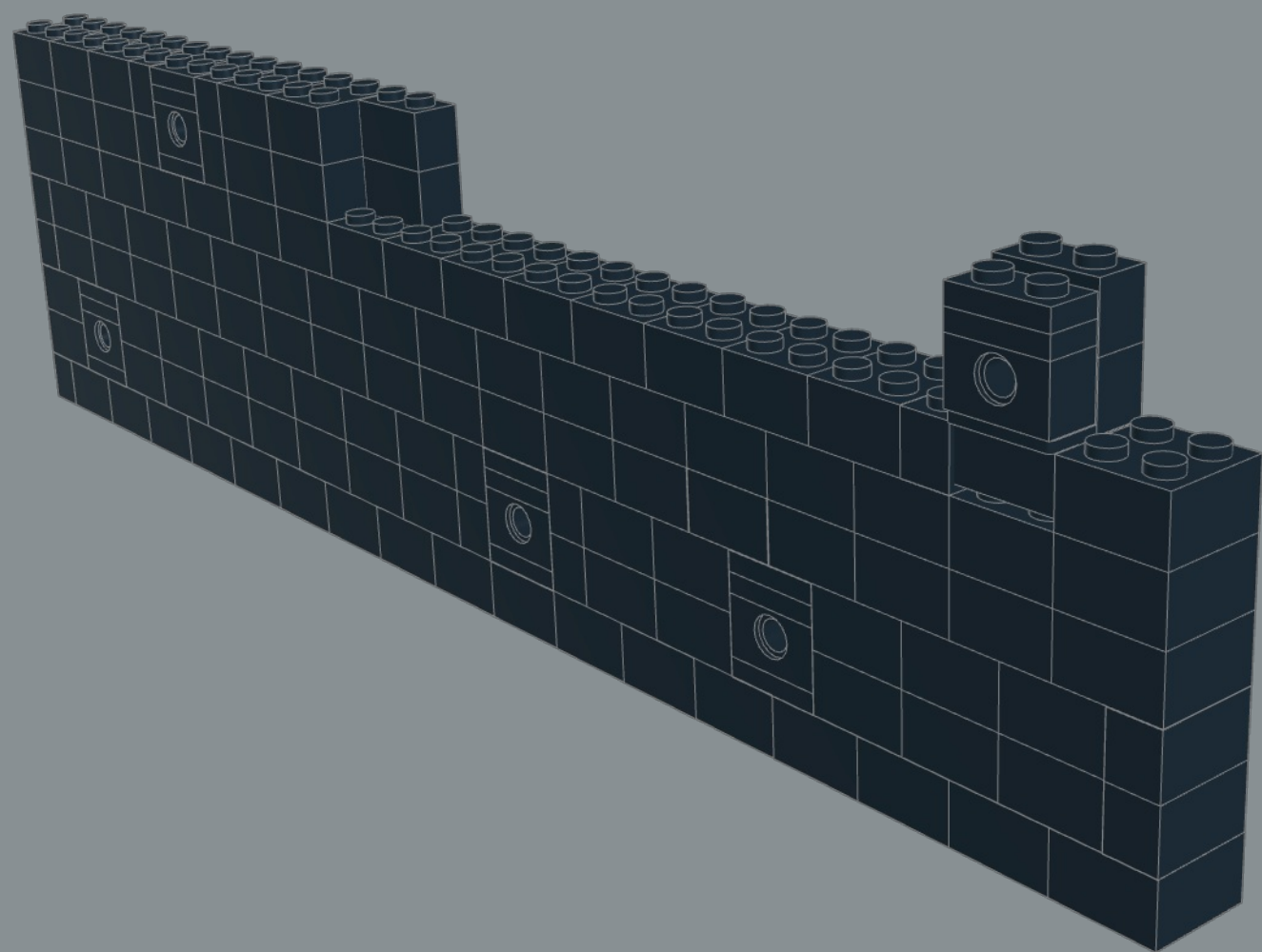
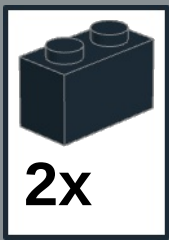

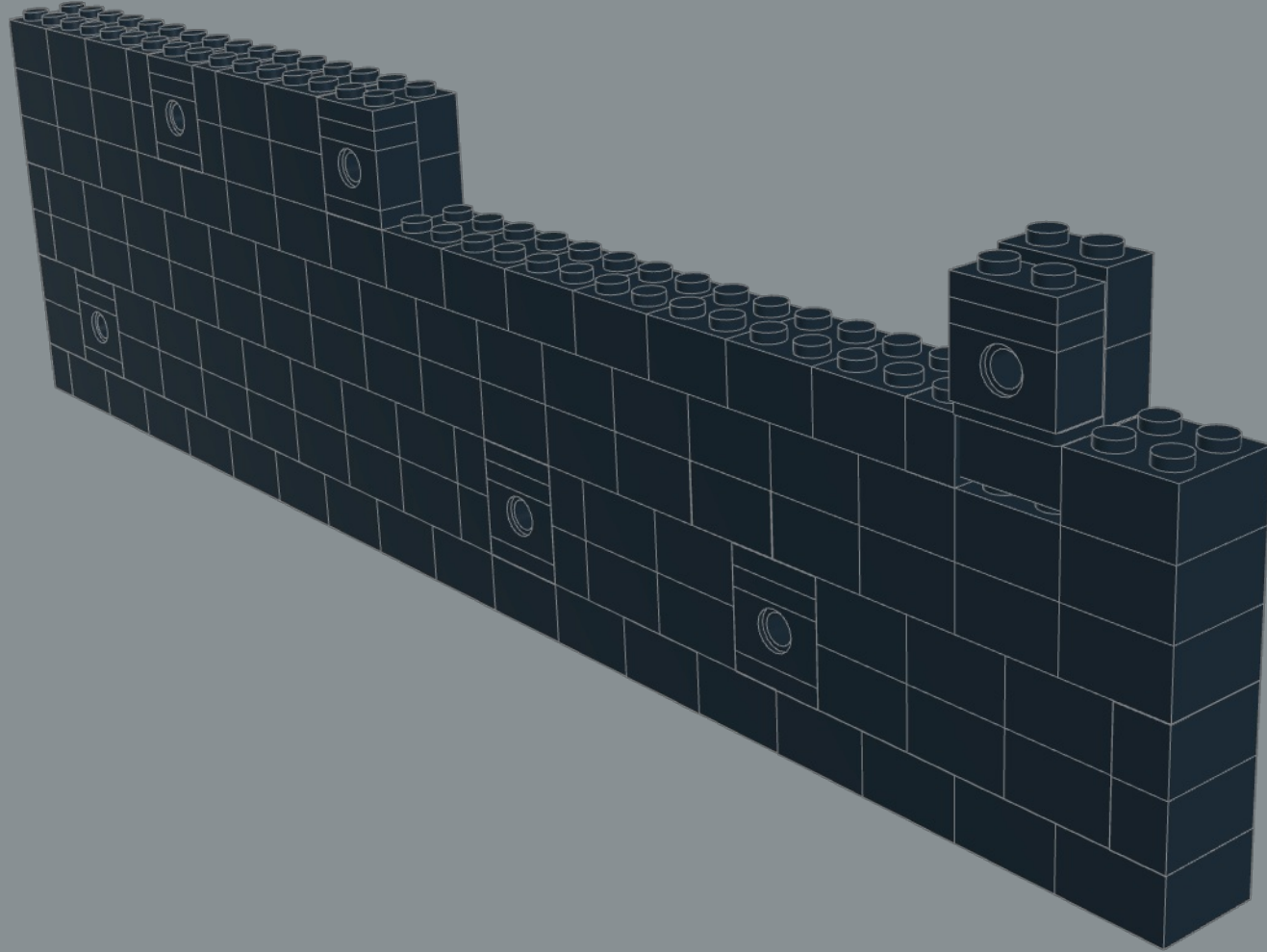

33

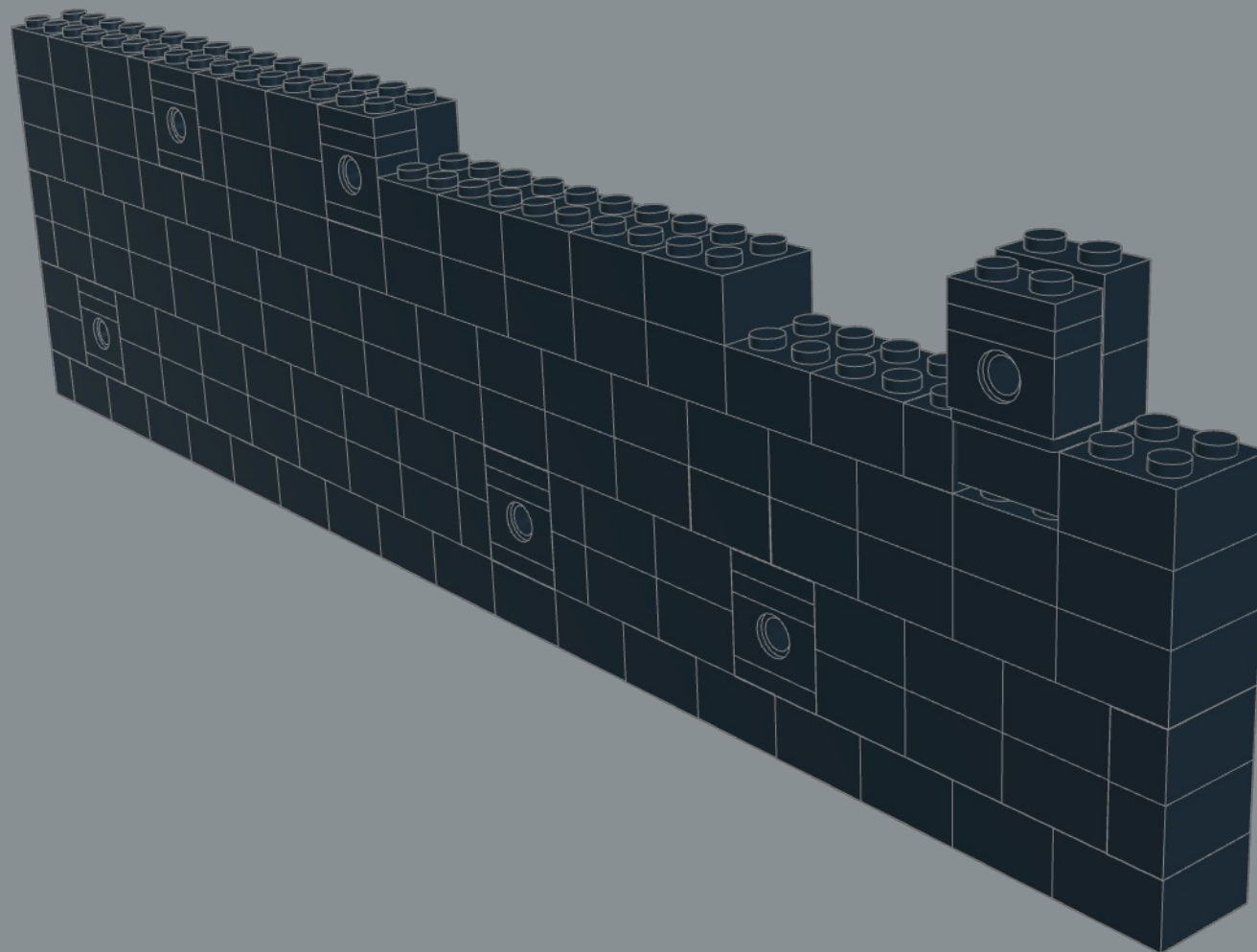
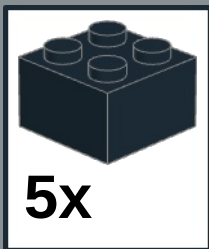

34

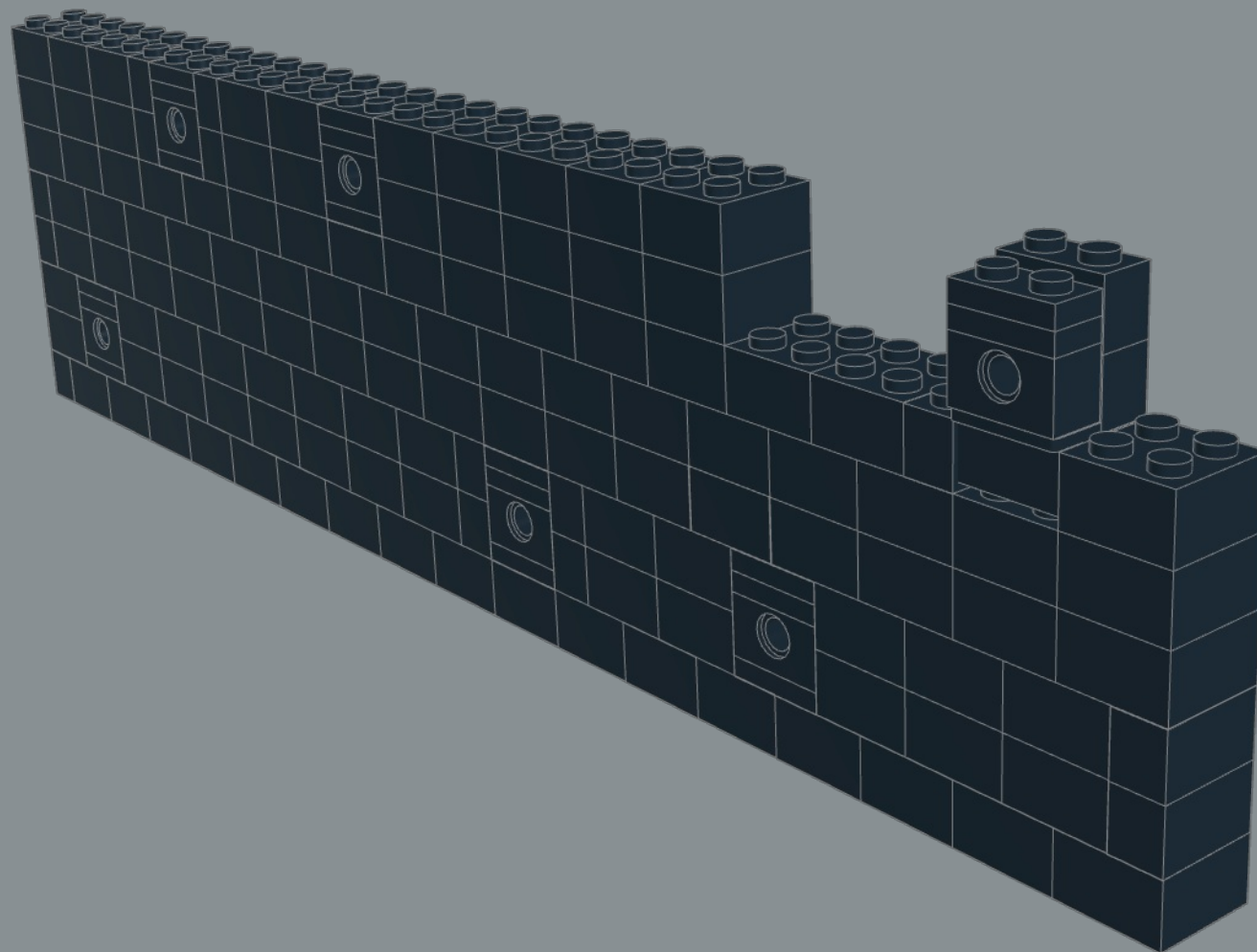
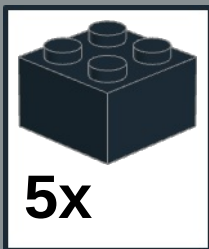

35

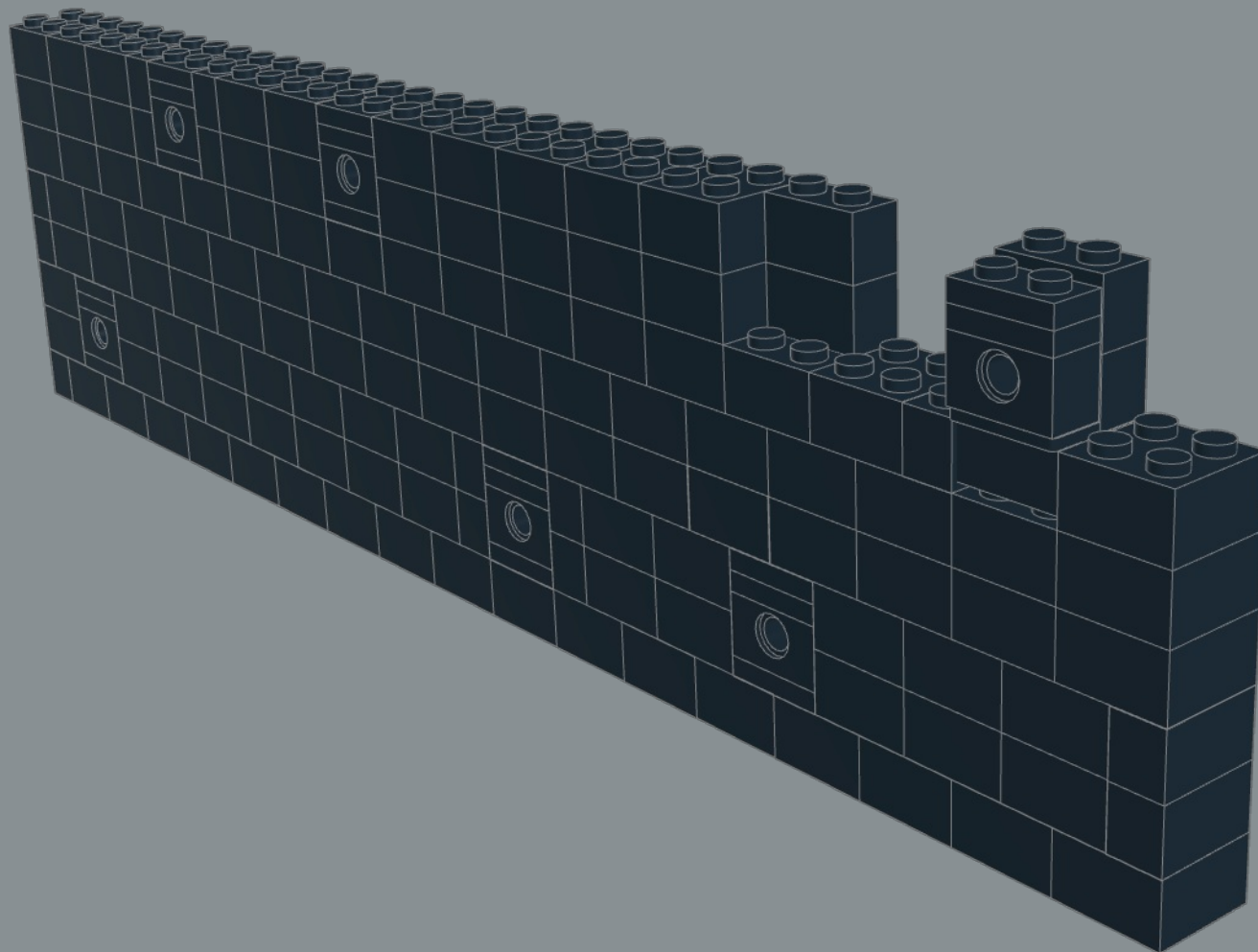
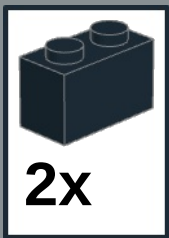

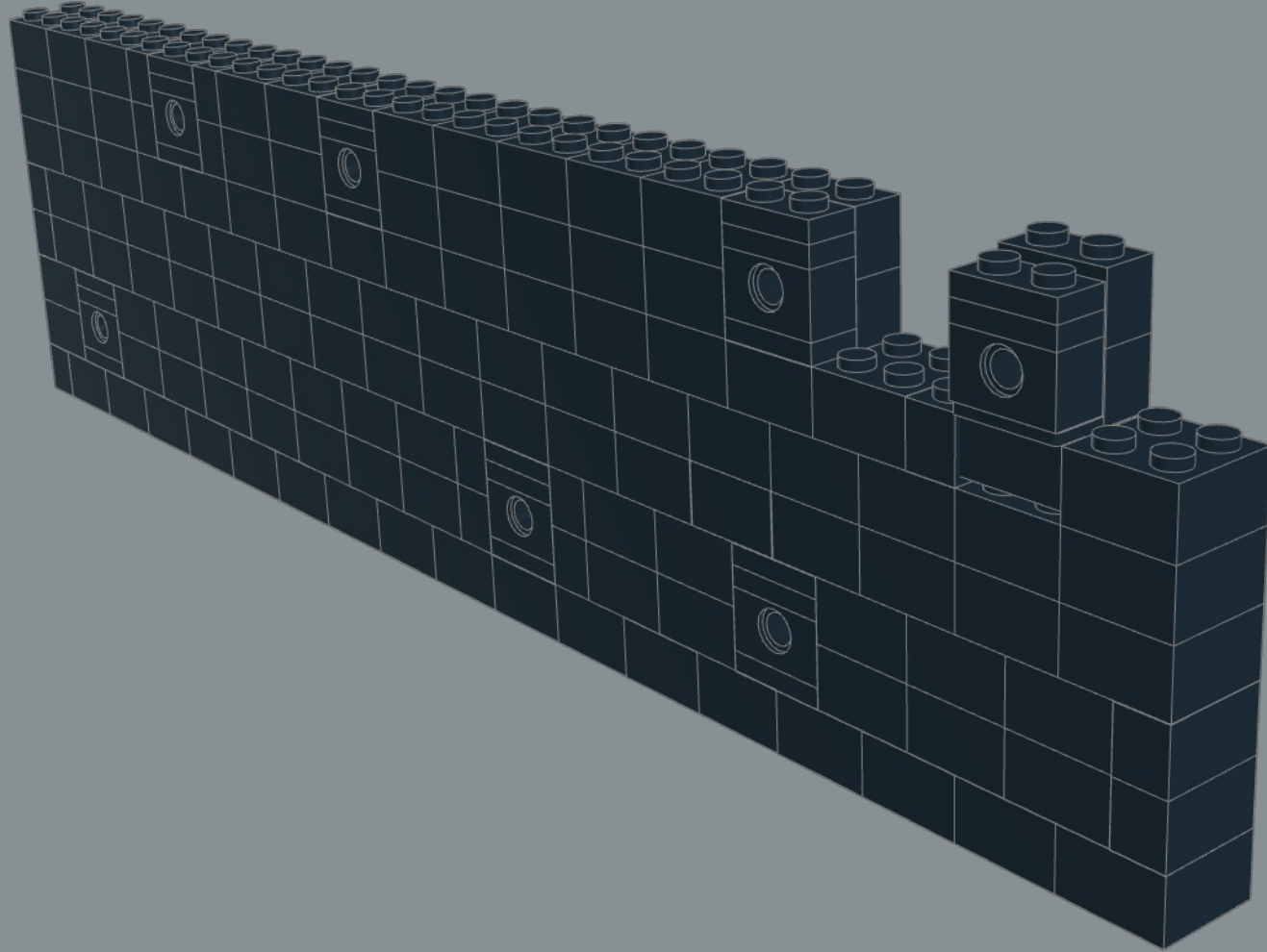

37

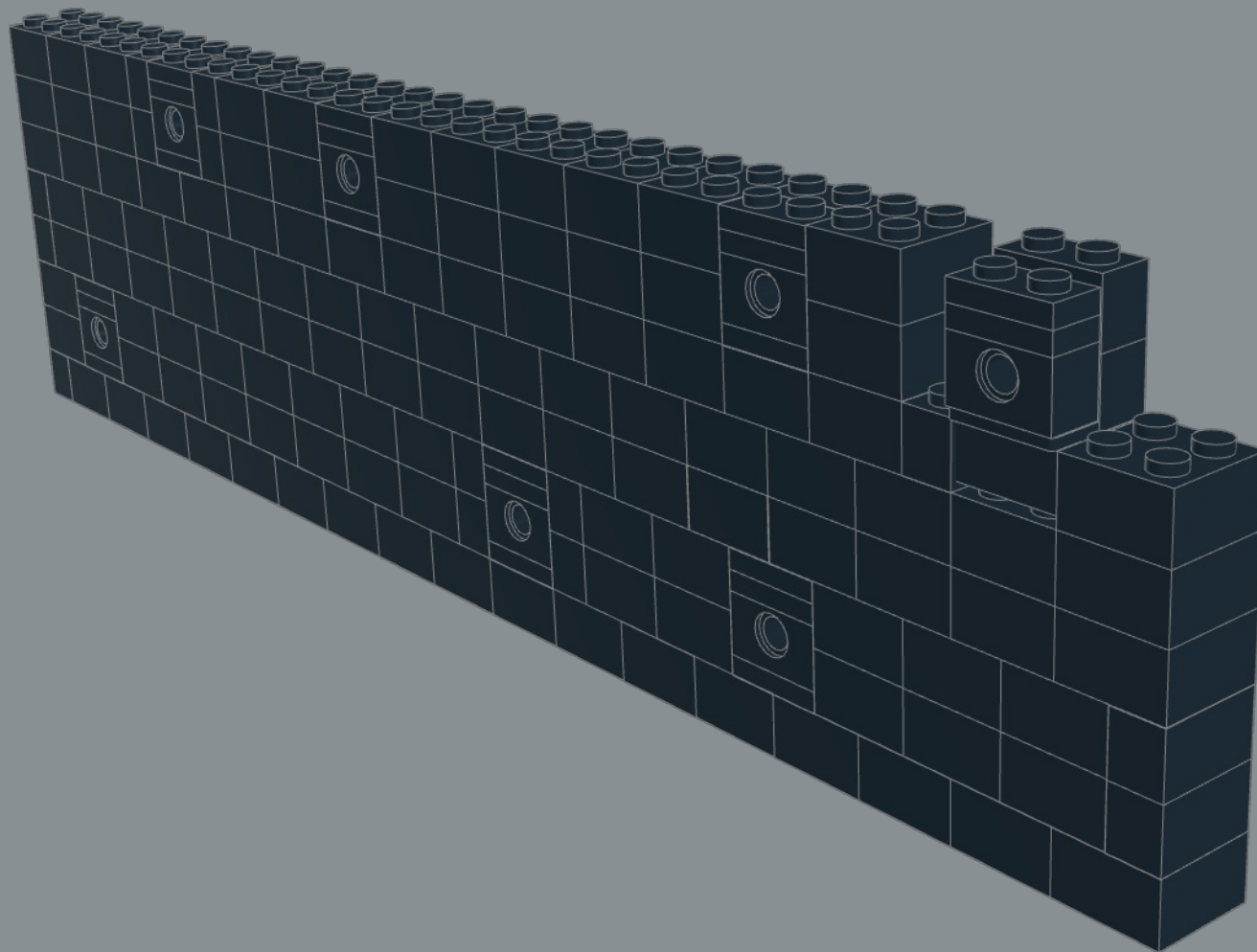
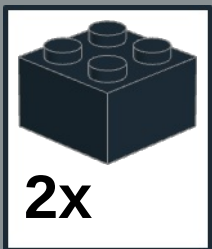

38

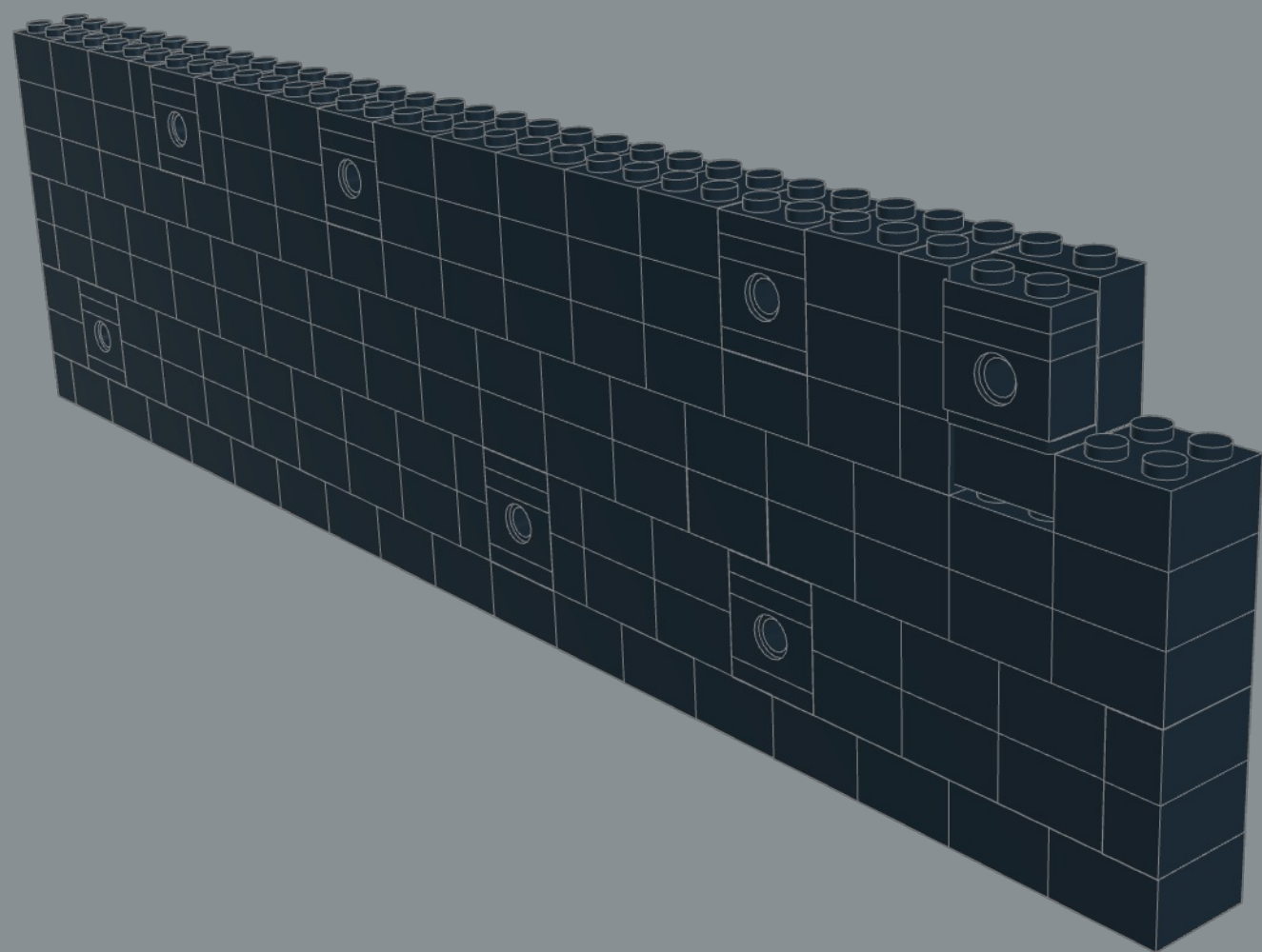
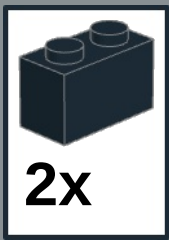

39

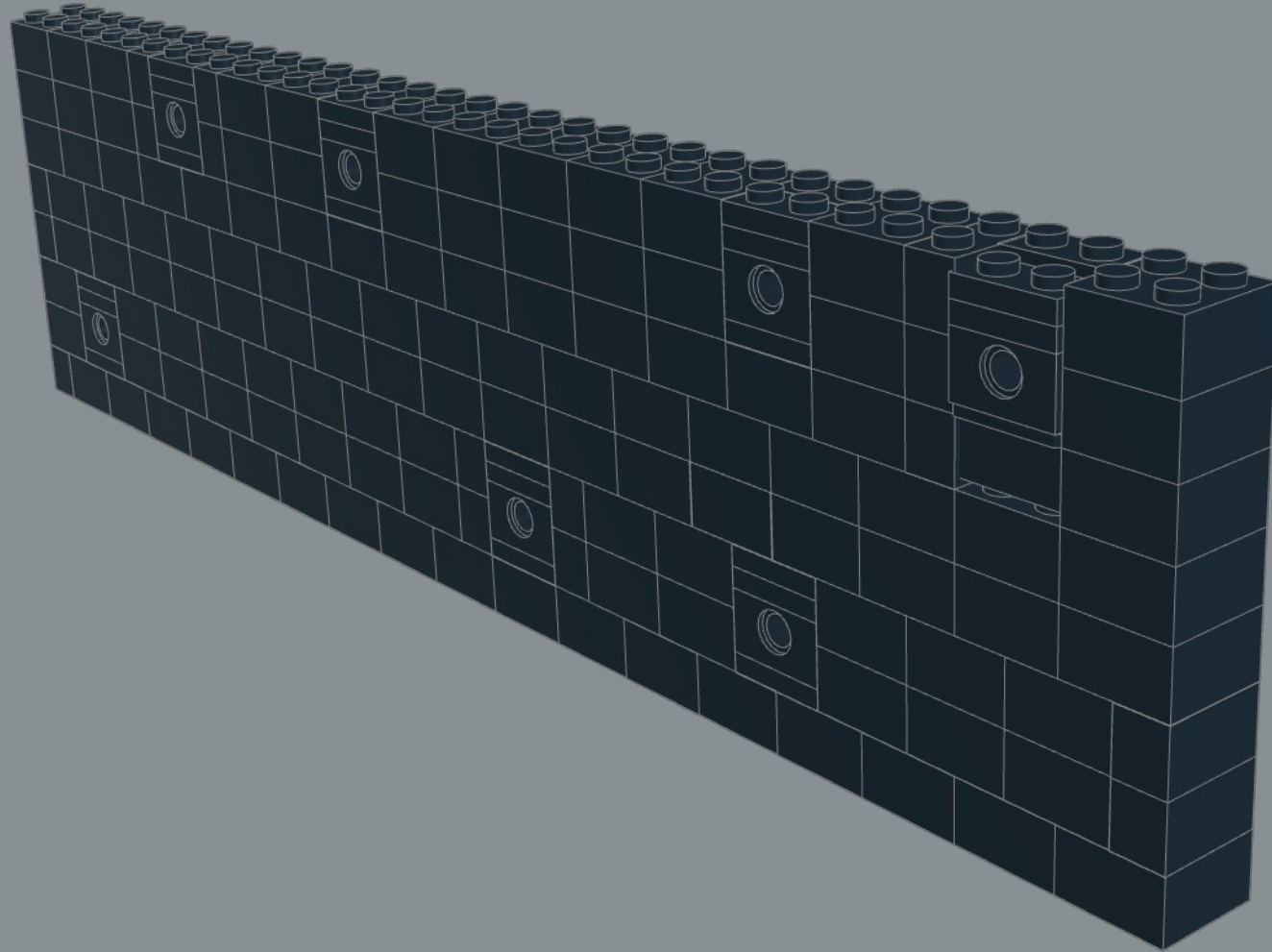
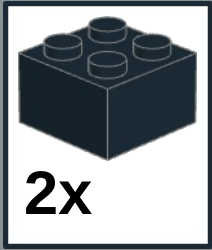

40

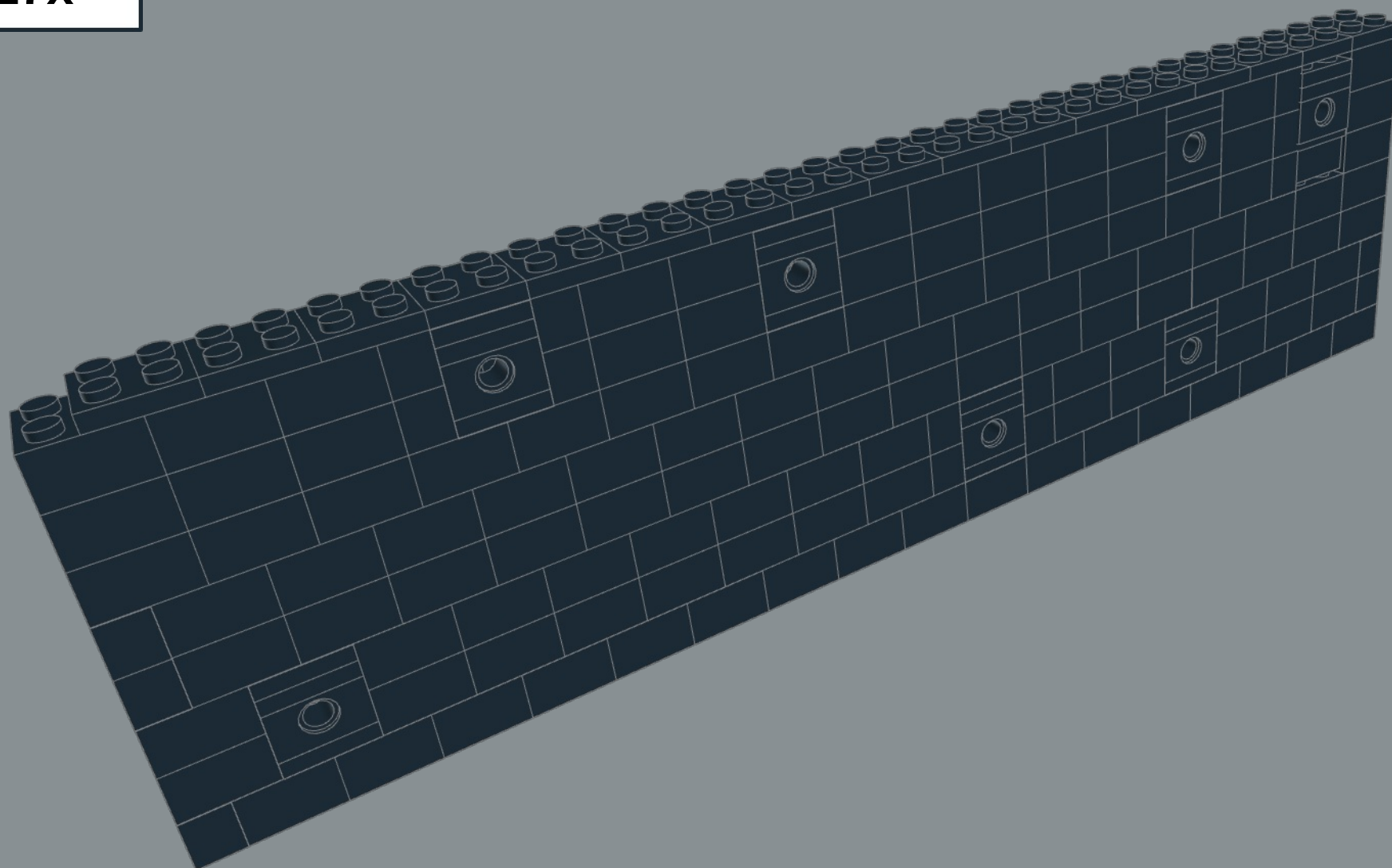
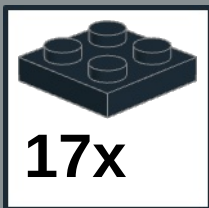

41

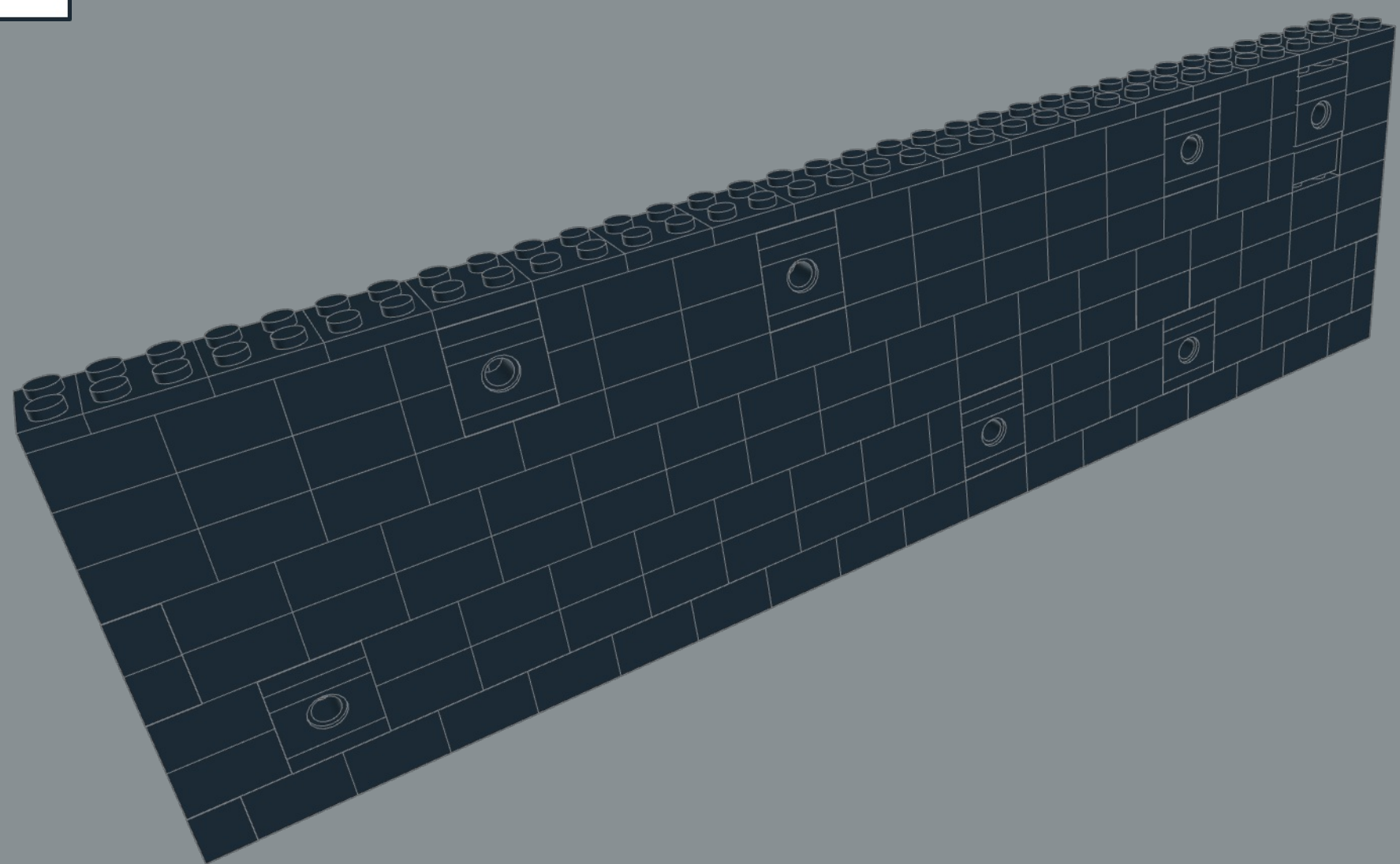
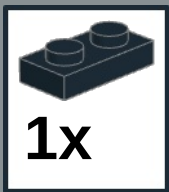

43

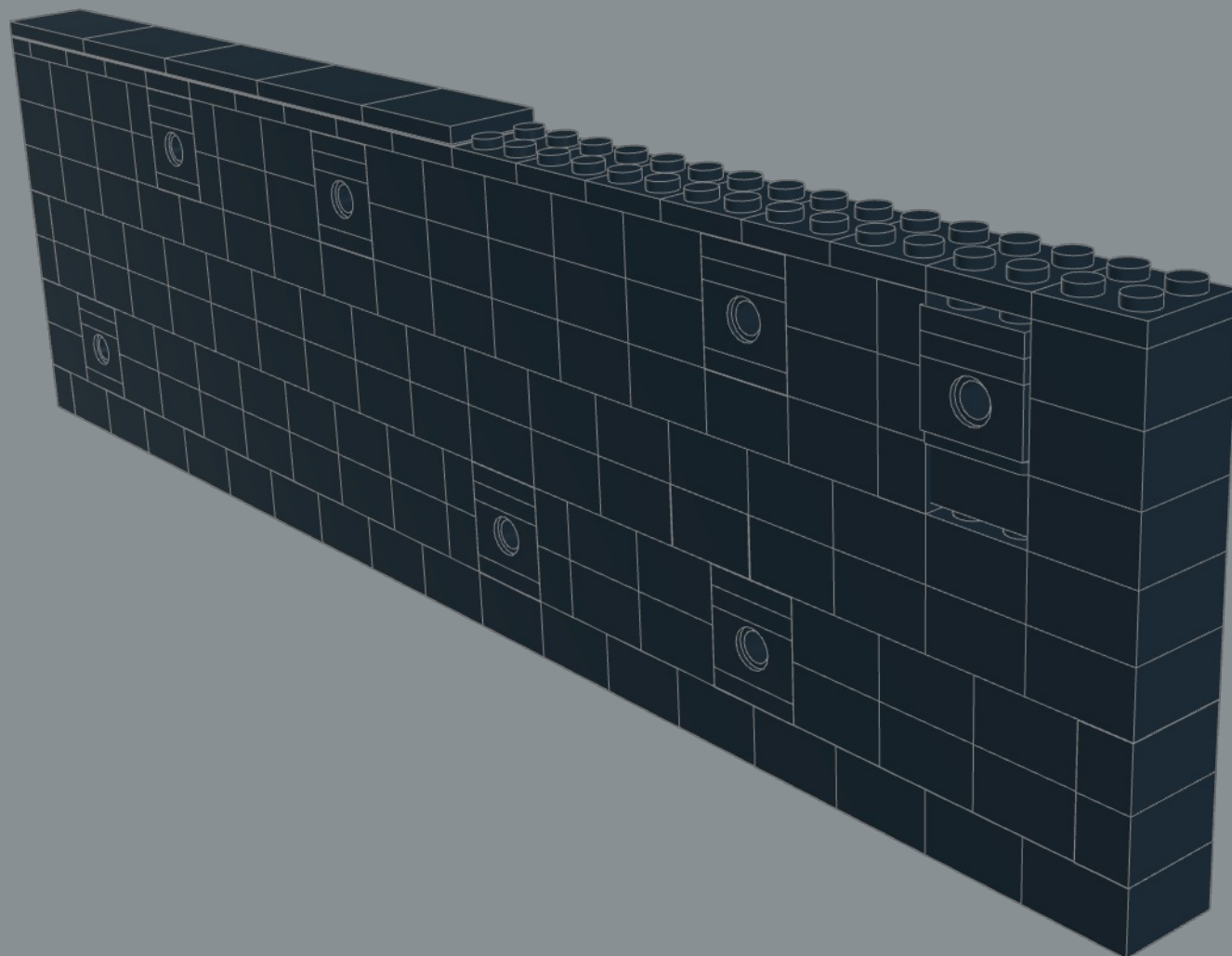
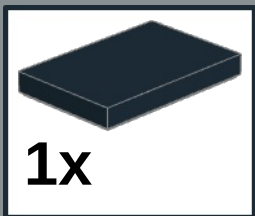

44

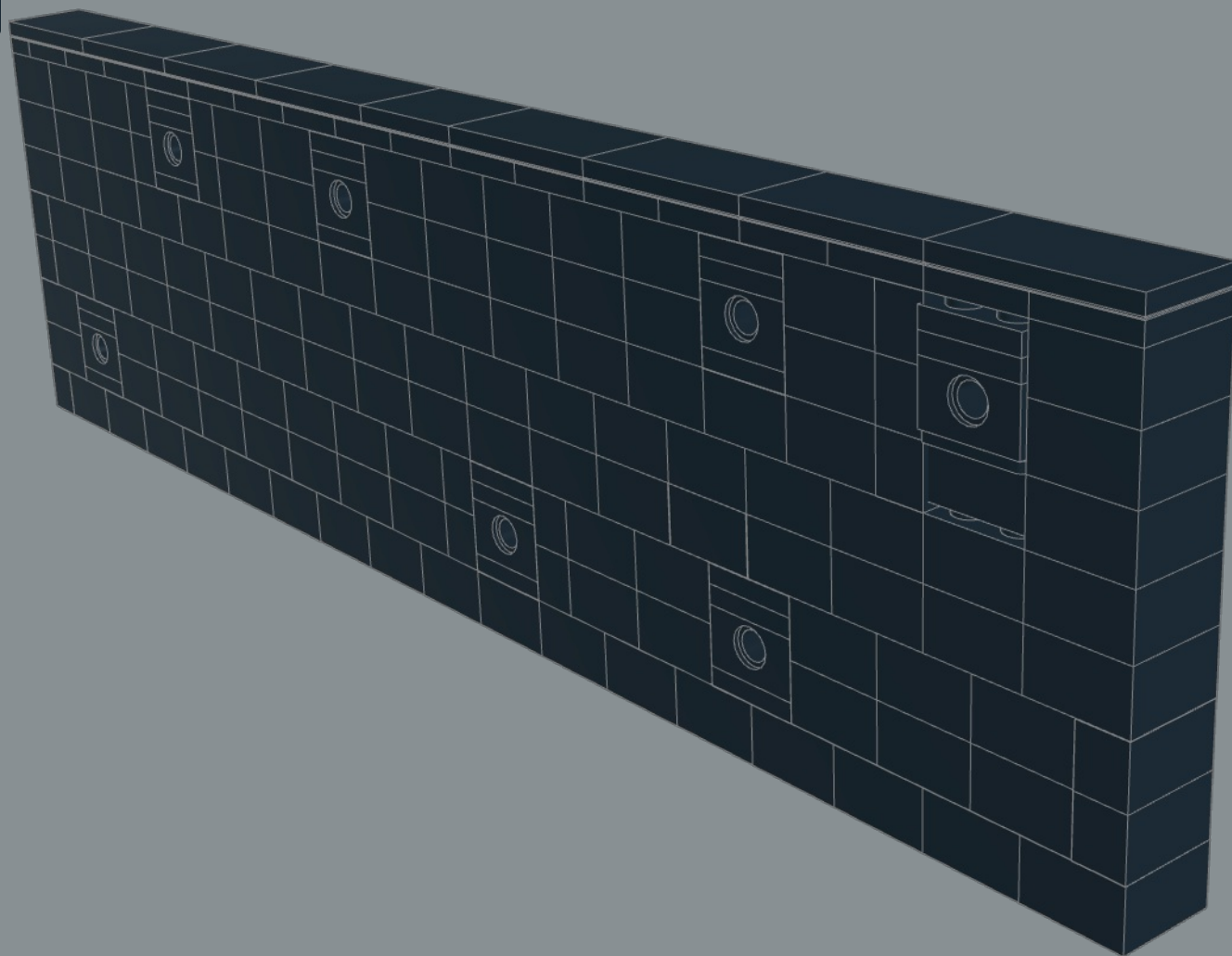
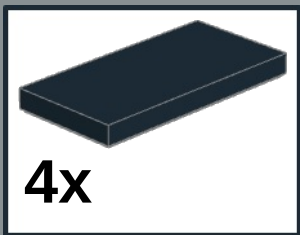

1

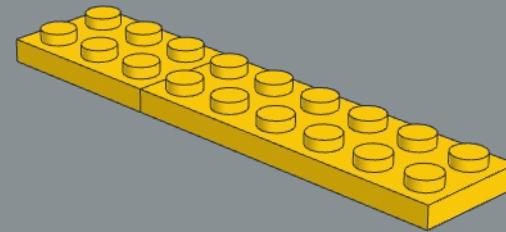
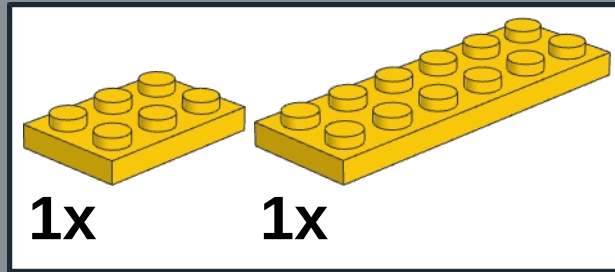

2

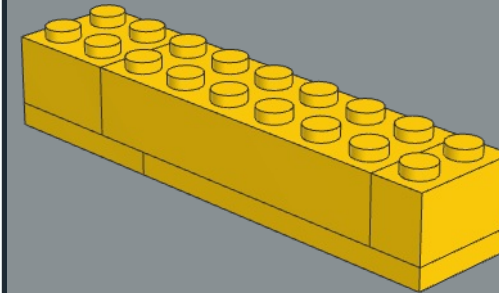
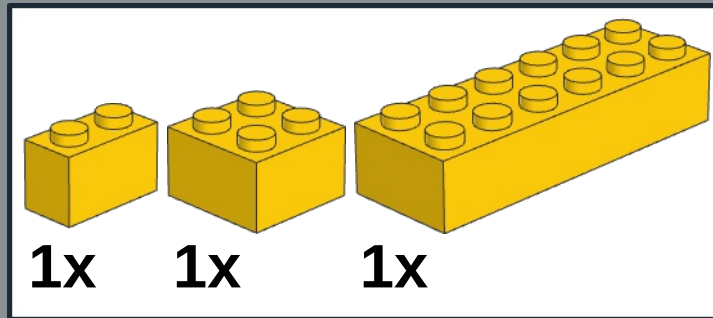

3

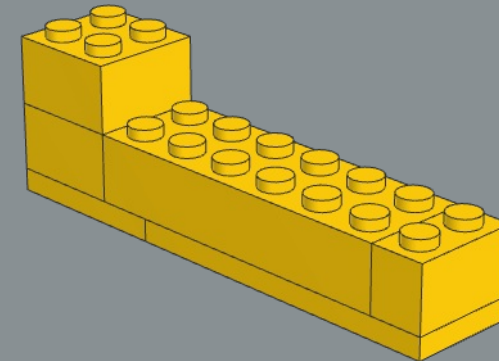
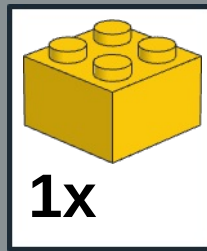

4

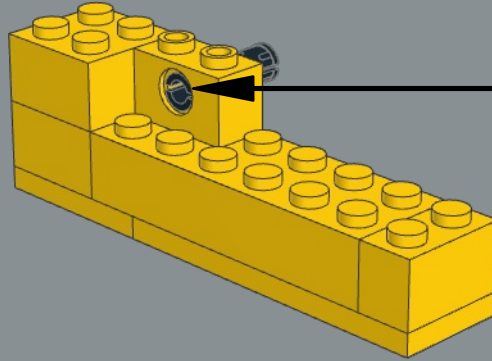

1x

1x

5

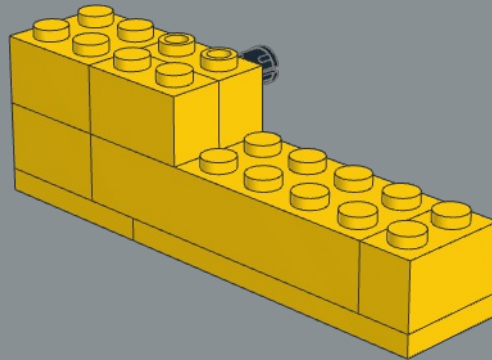

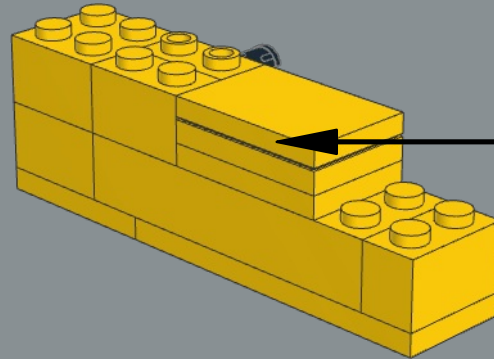

- 1**

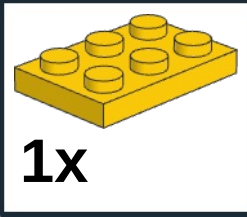

1x

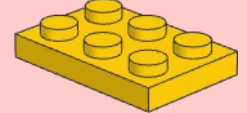
- 2**

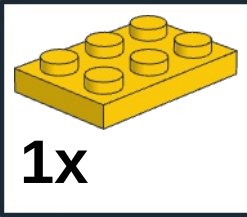

1x

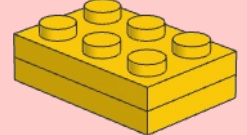
- 3**

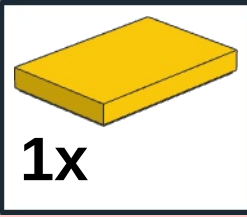

1x

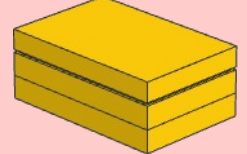

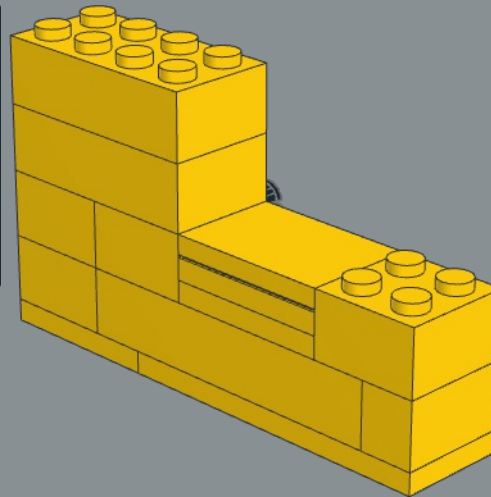
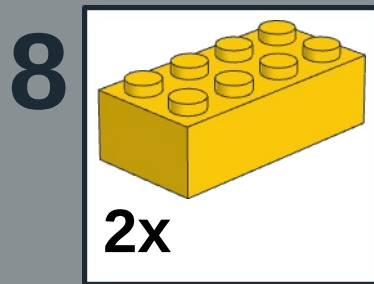
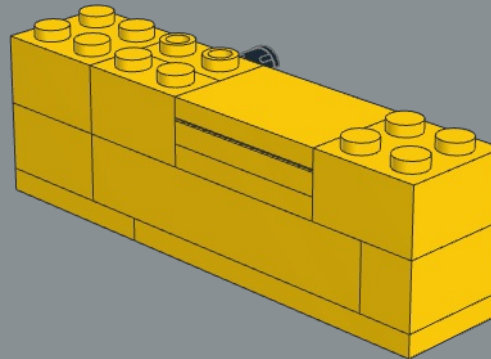
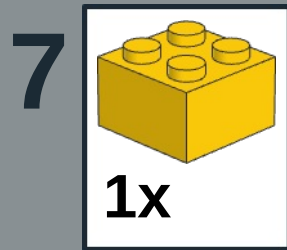

9

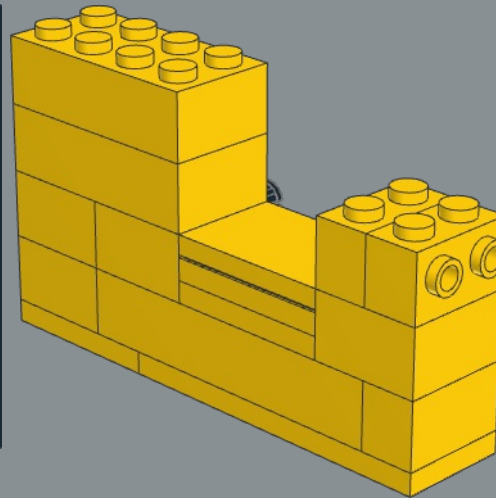
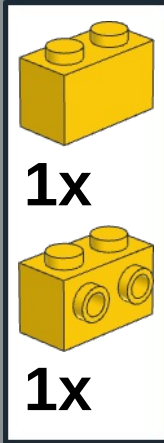

10

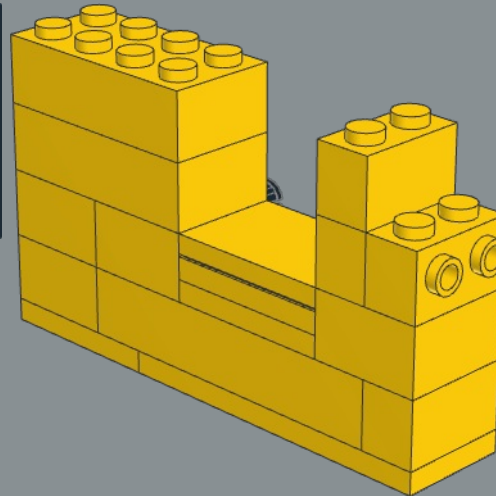
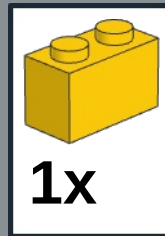

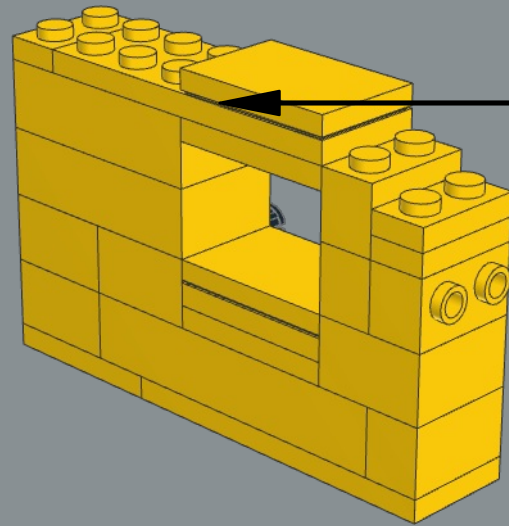

1

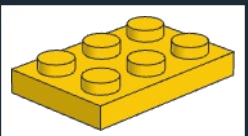

1x

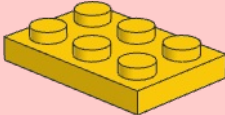

2

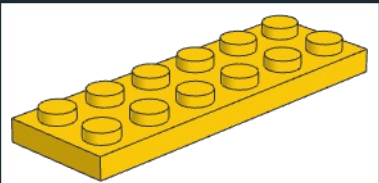

1x

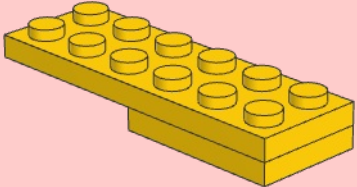

3

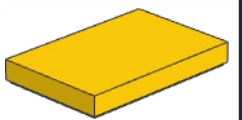

1x

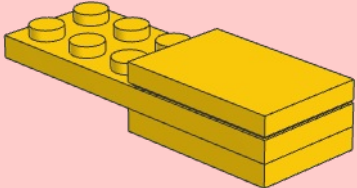

14

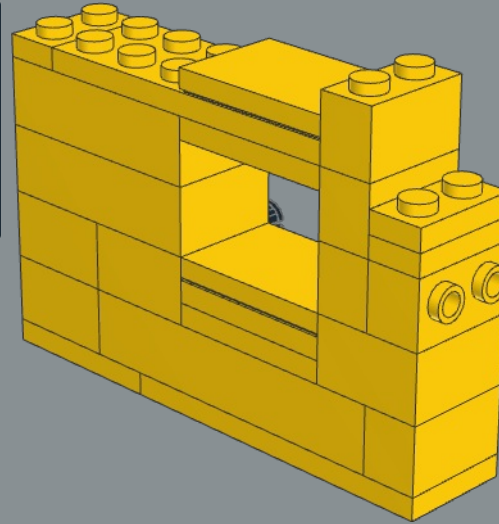
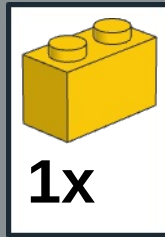

15

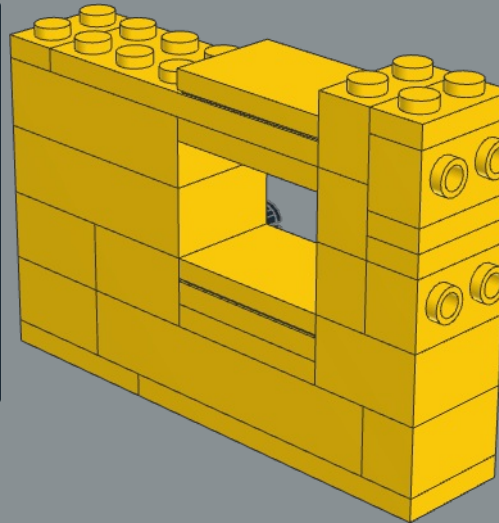
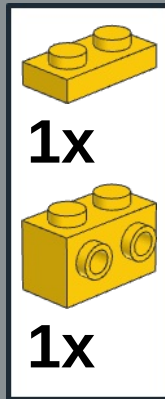

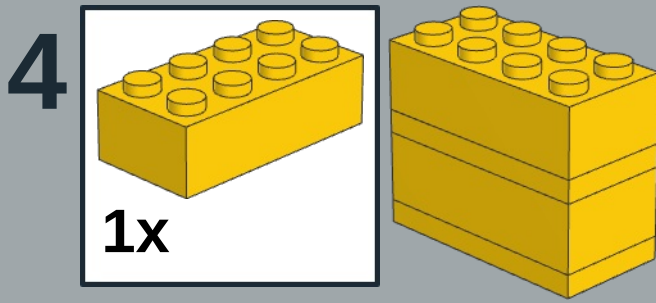
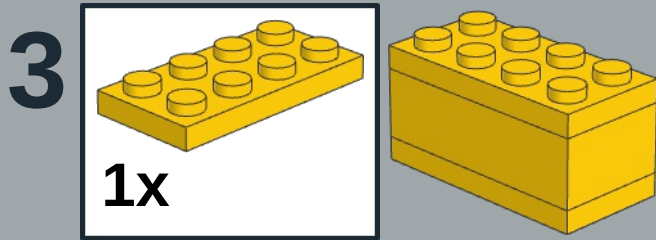
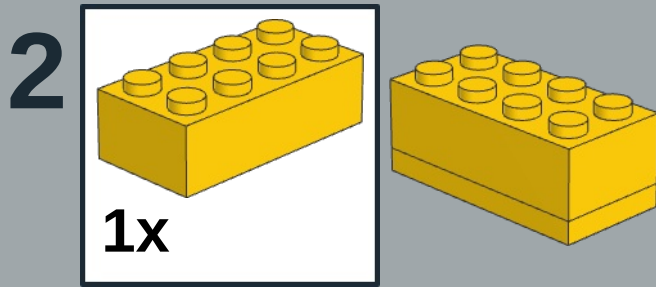
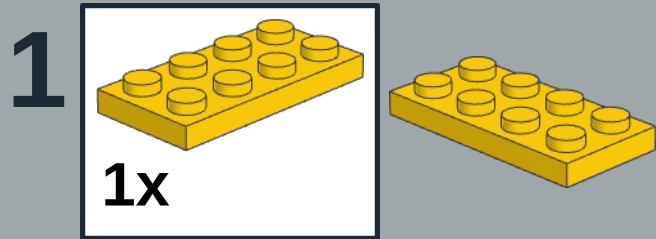

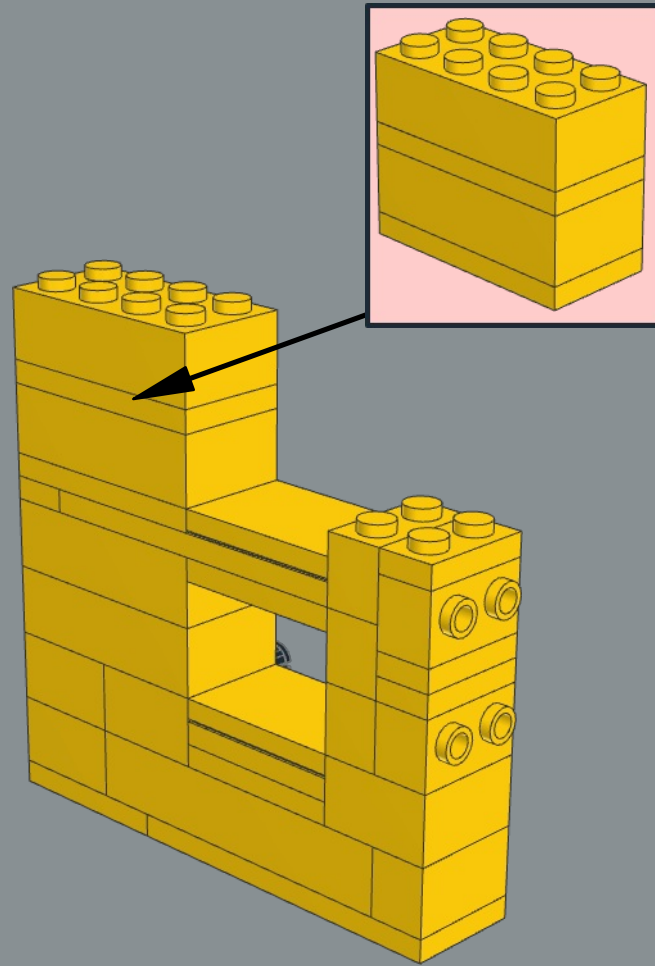

17

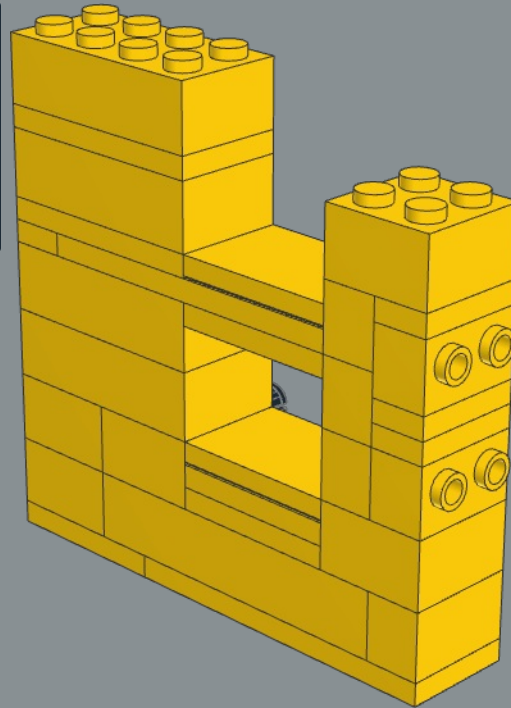
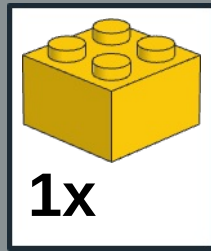

18

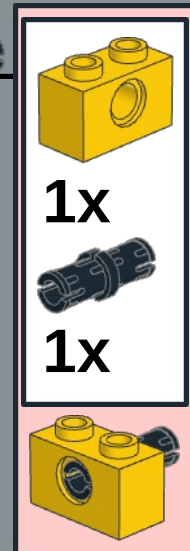
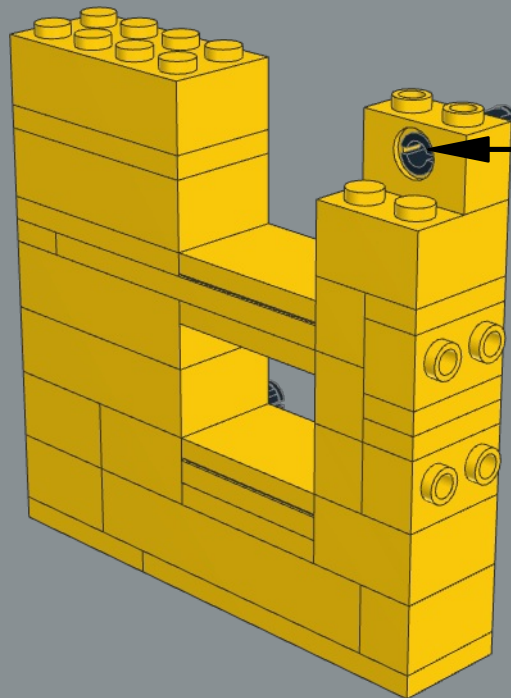

19

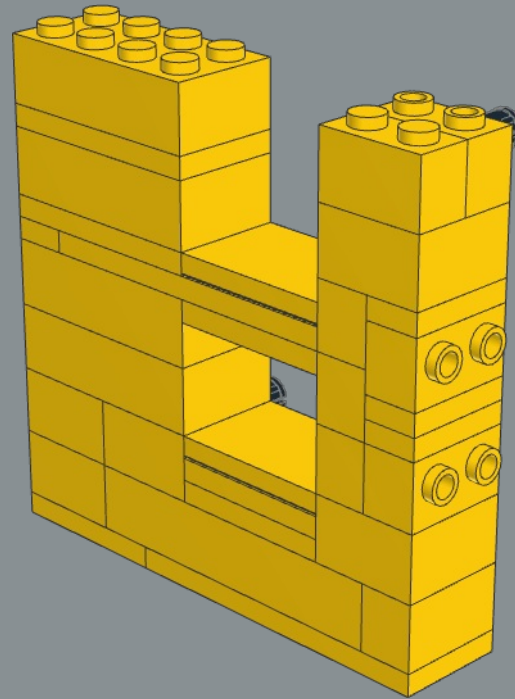
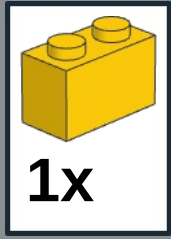

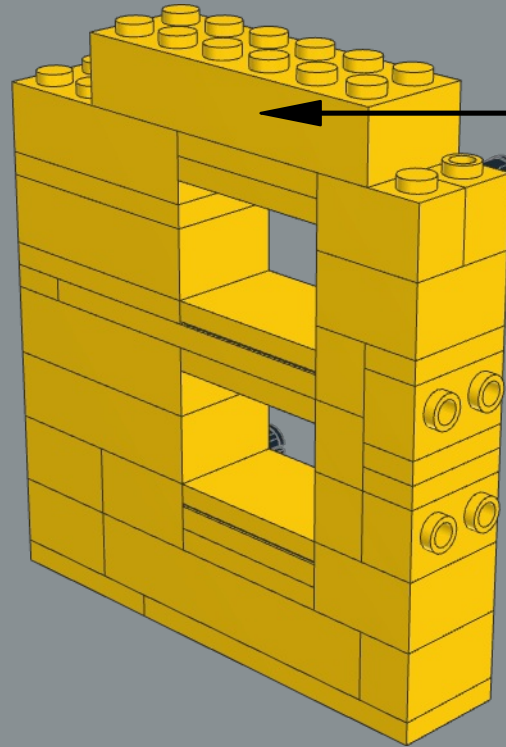

1

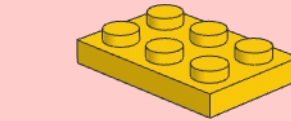
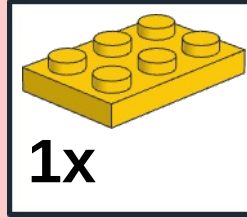

2

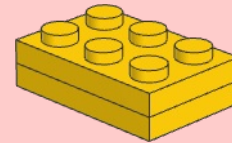
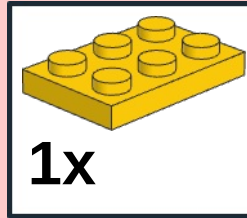

3

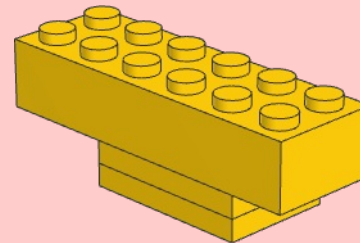
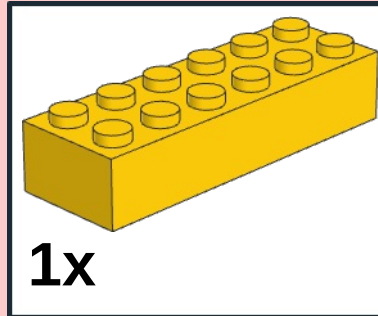

21

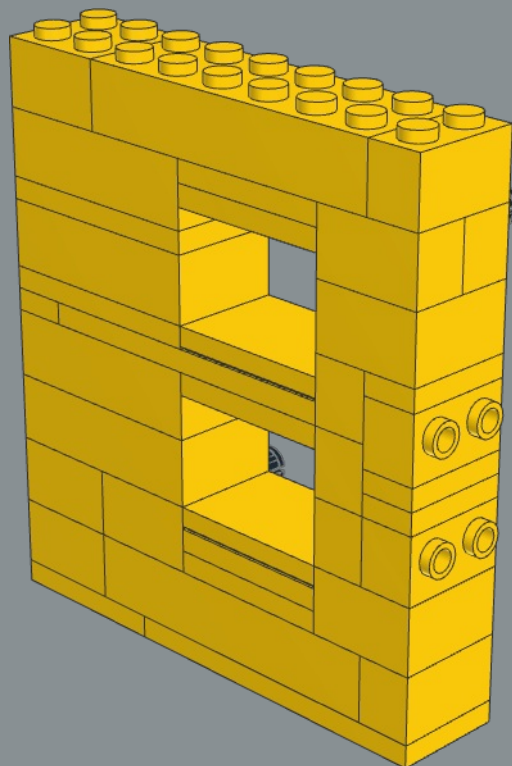
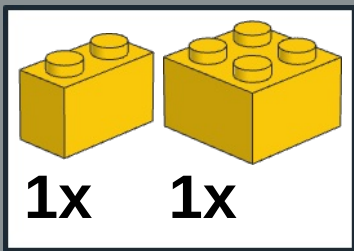

22

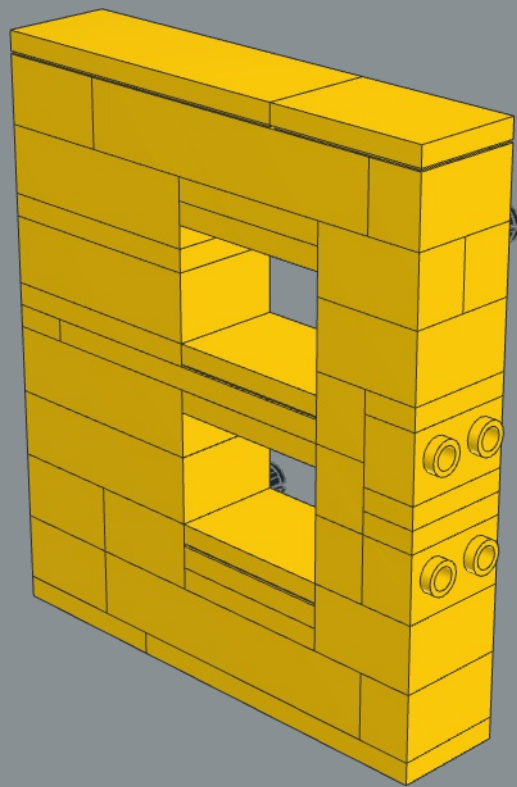
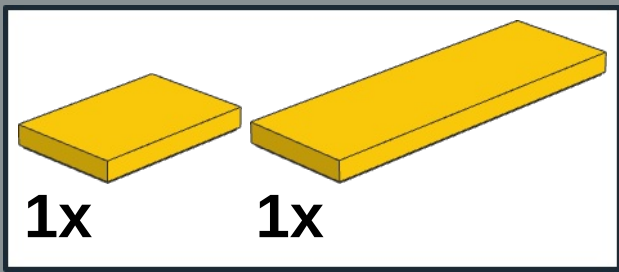

1

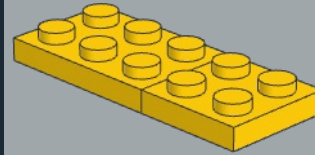
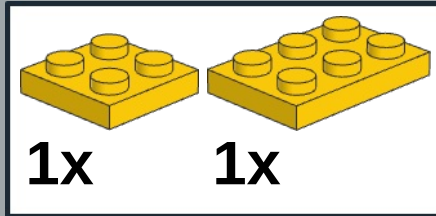

2

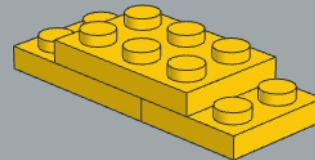
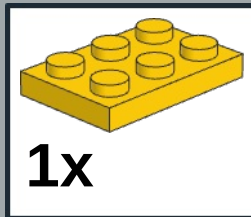

3

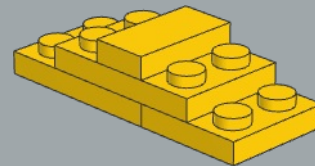
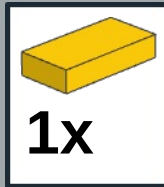

4

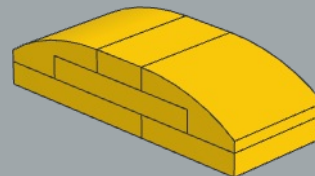
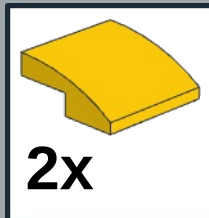

x2

23

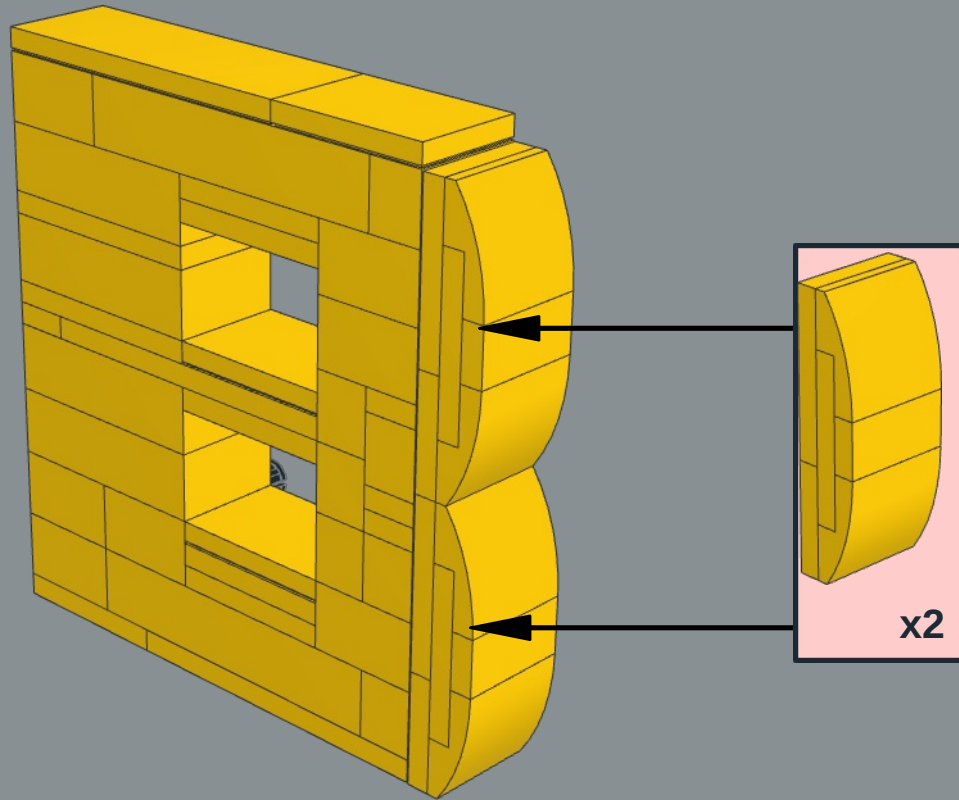

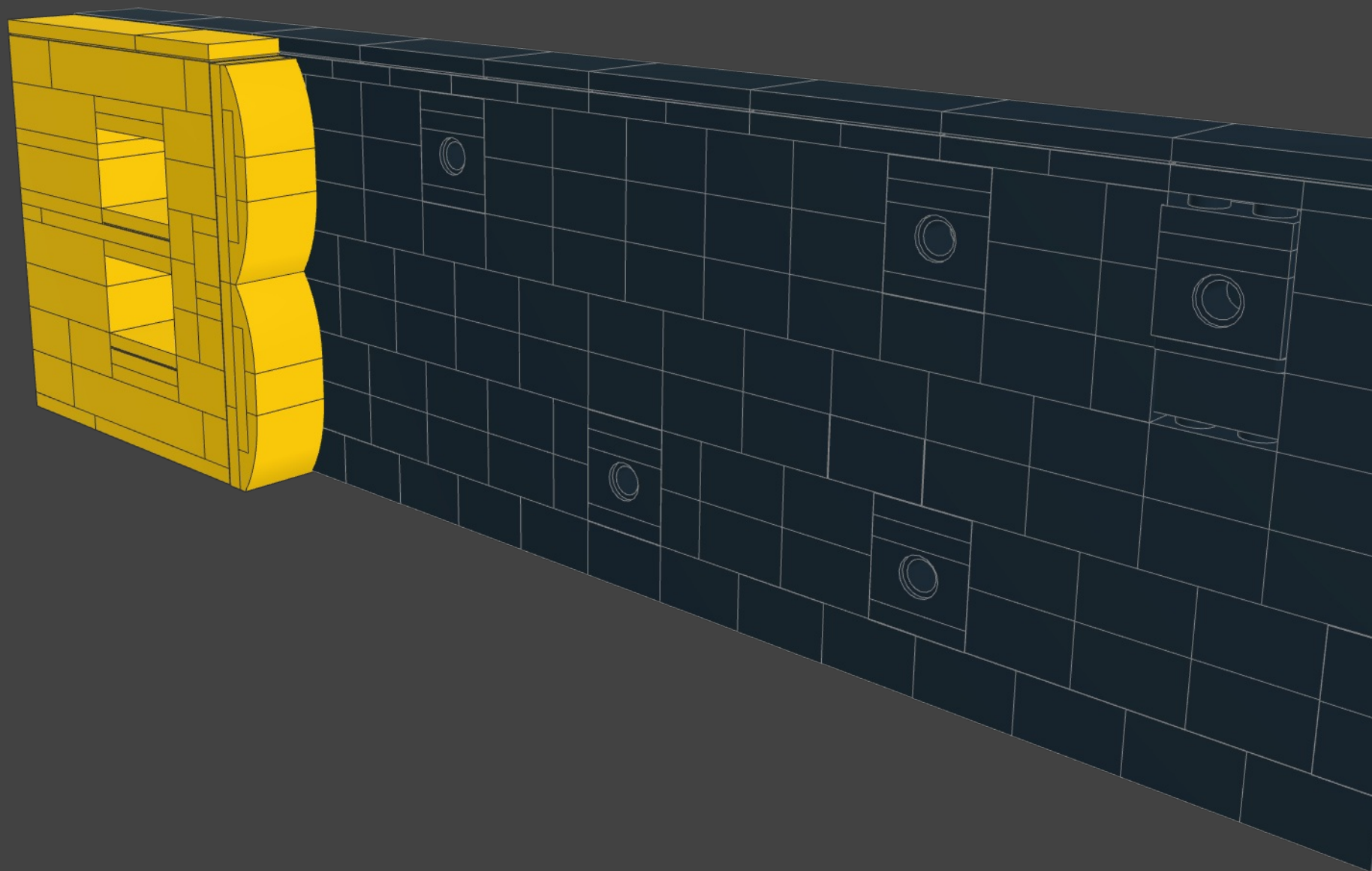

1

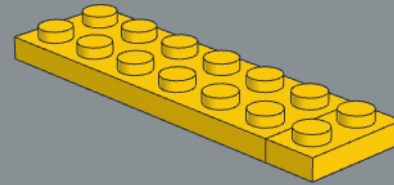
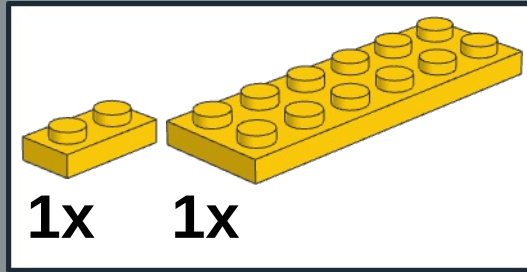

2

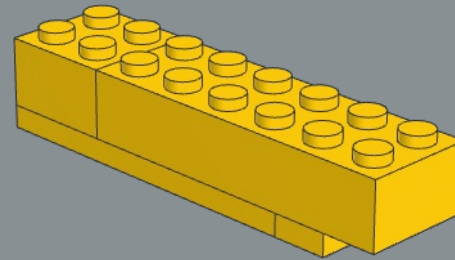
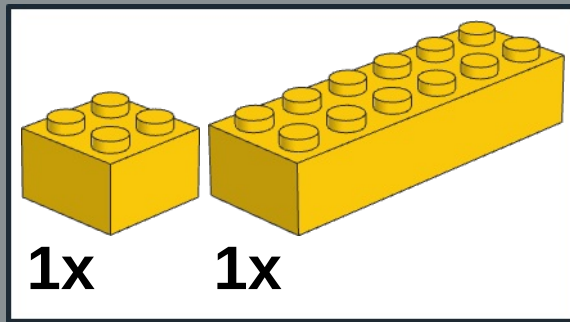

3

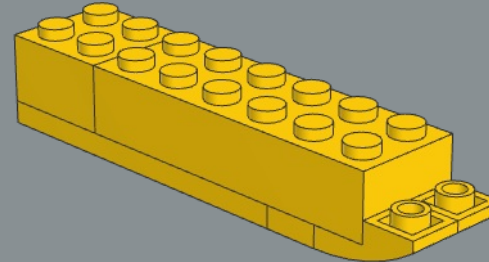
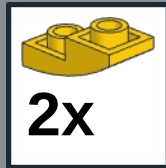

4

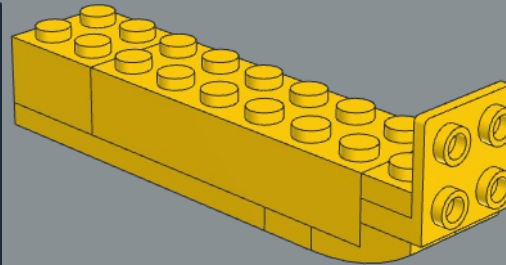
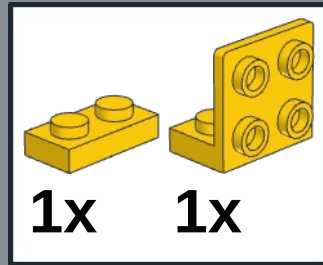

5

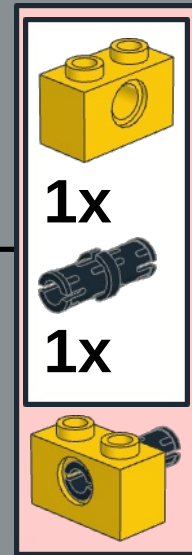
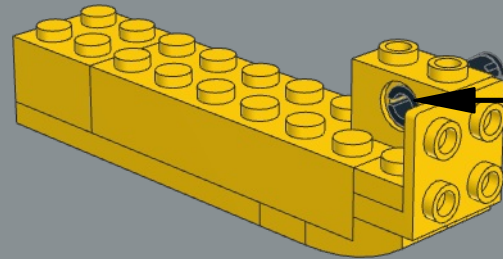

1

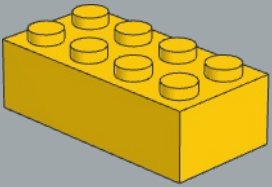
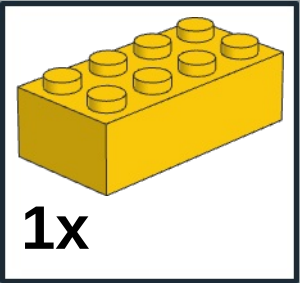

2

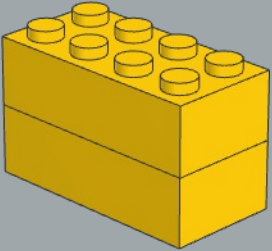
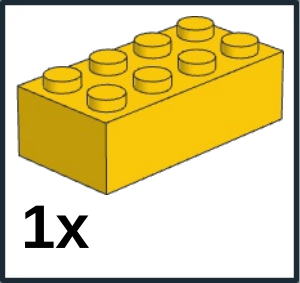

3

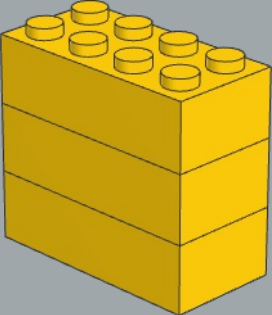
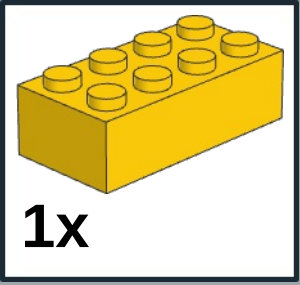

4

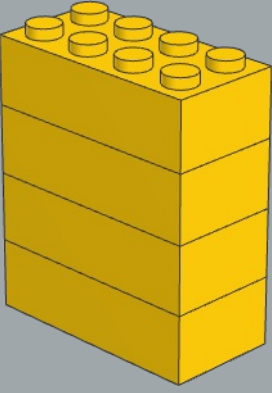
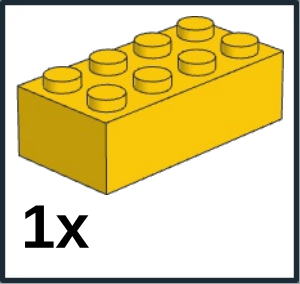

6

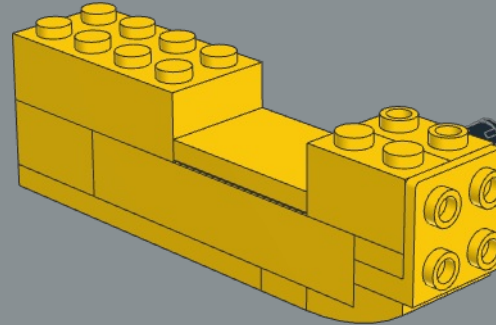
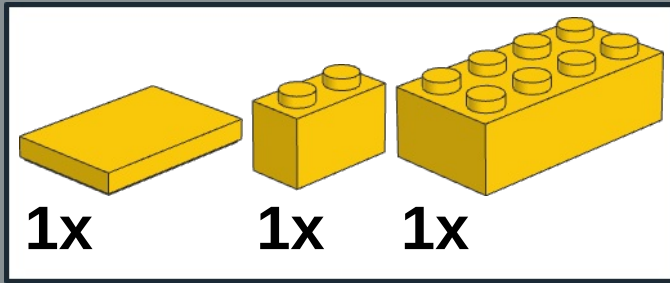

7

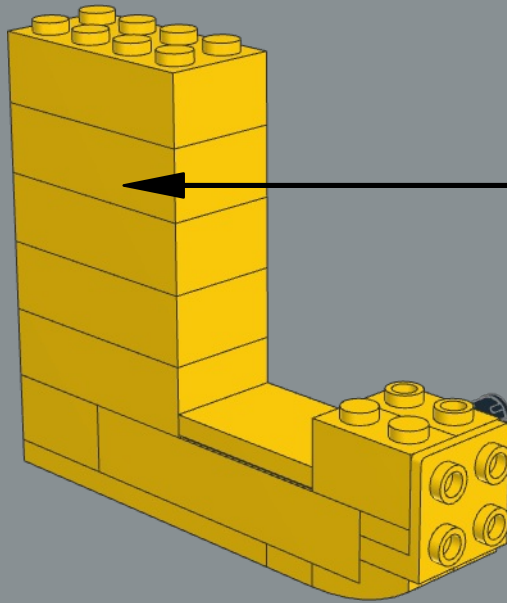

8

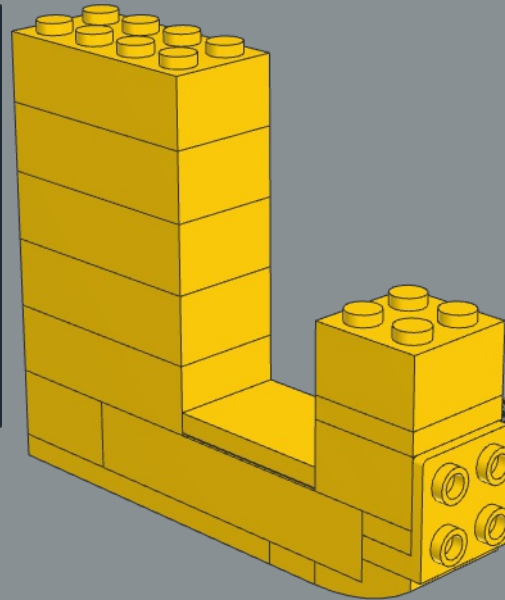
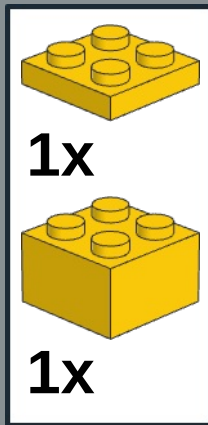

9

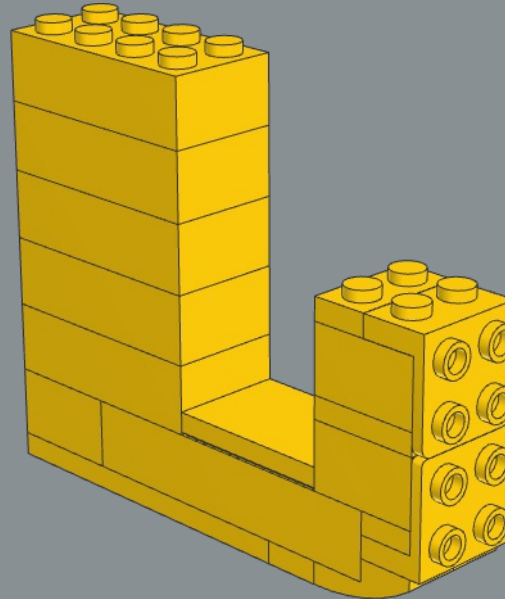
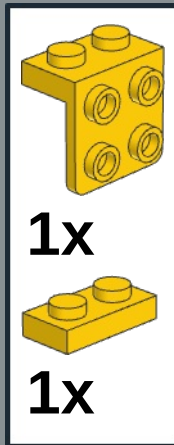

10

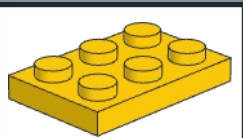

1x

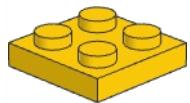

1x

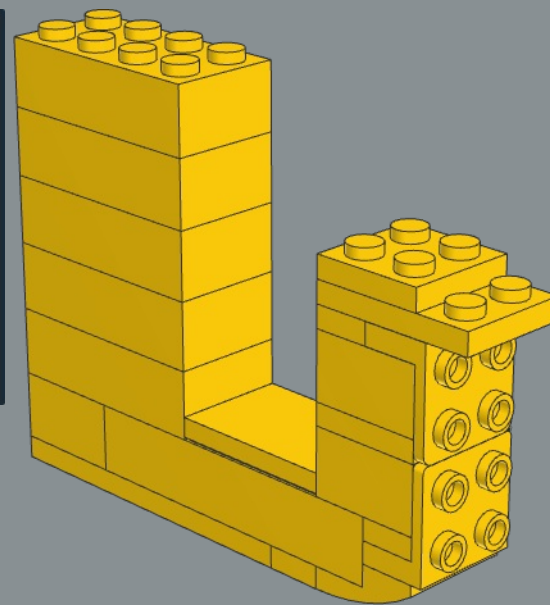

11



1x

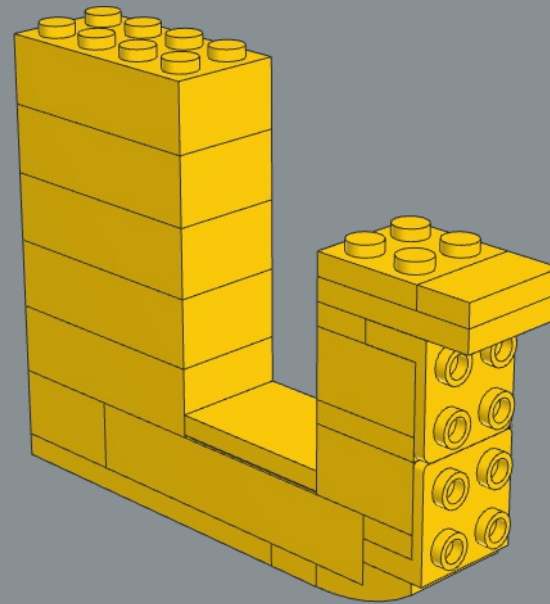

12

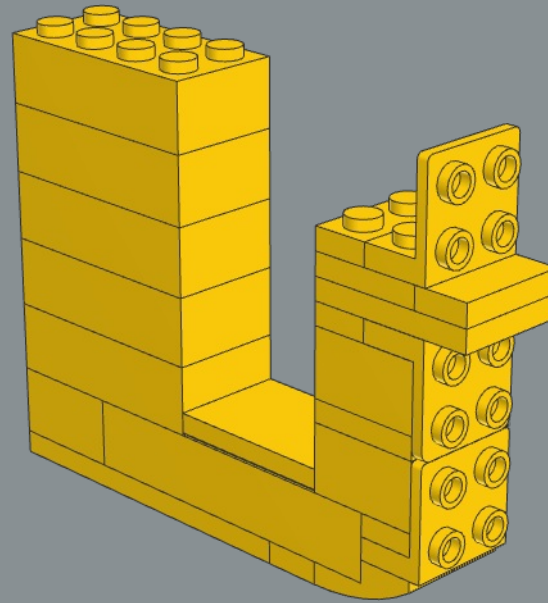
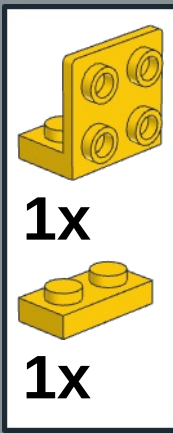

13

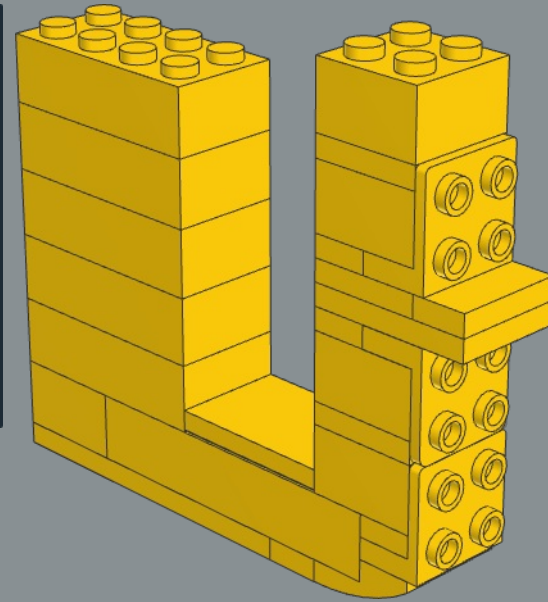
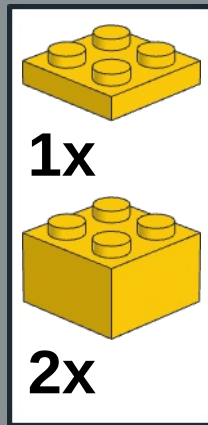

14

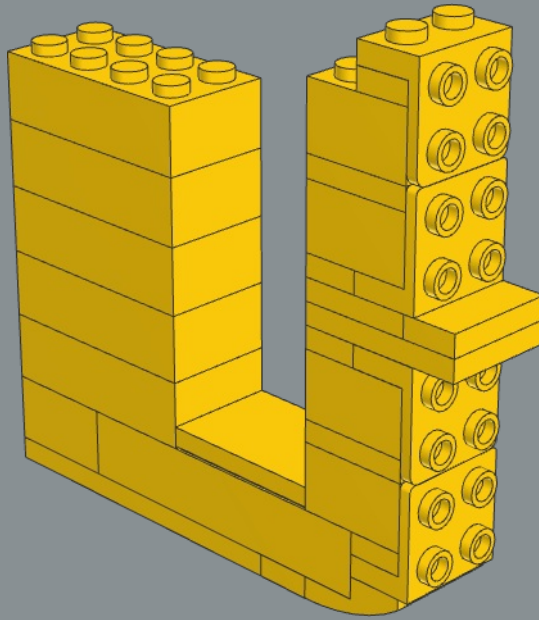
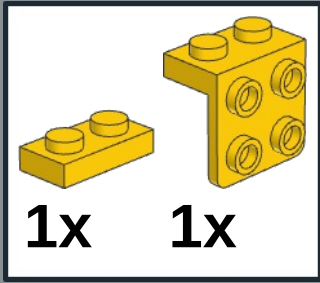

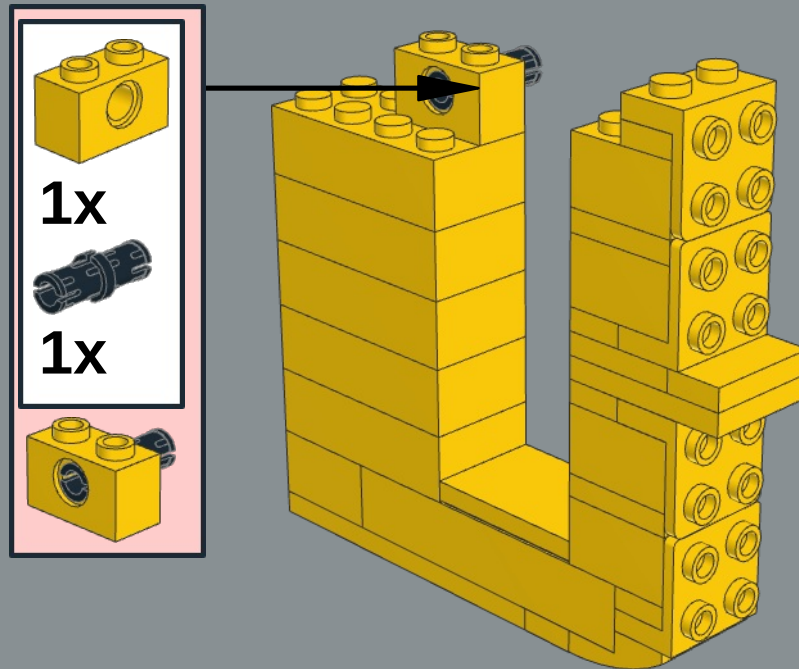

16

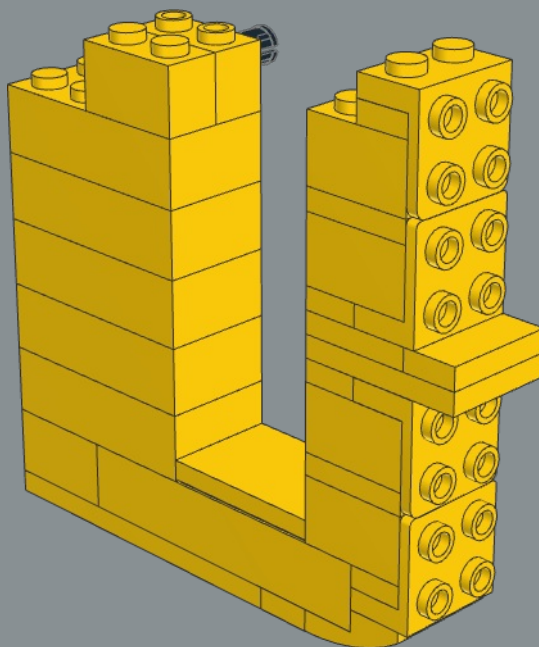
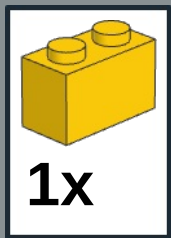

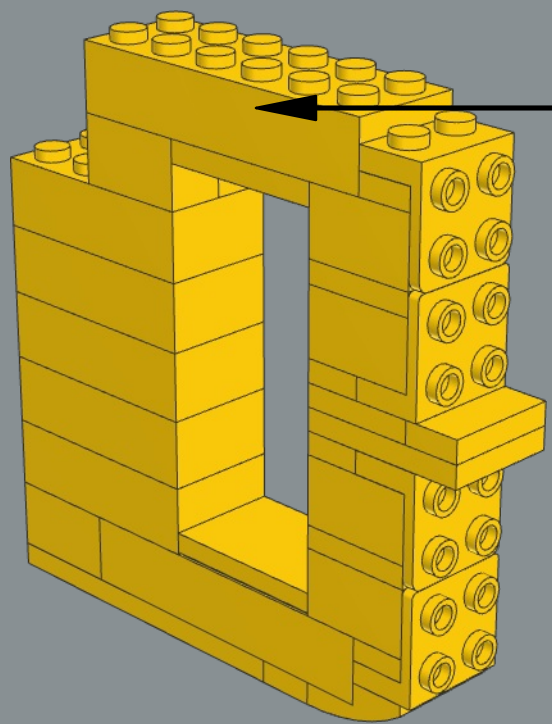

1

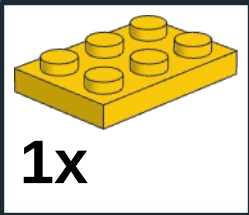

1x

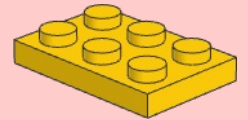

2

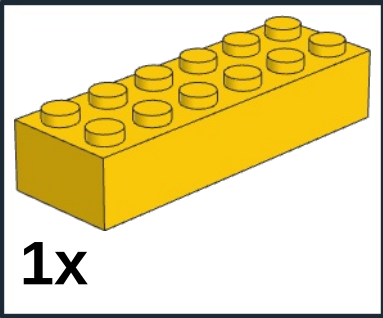

1x

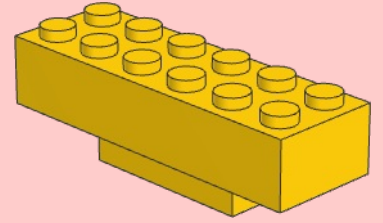

18

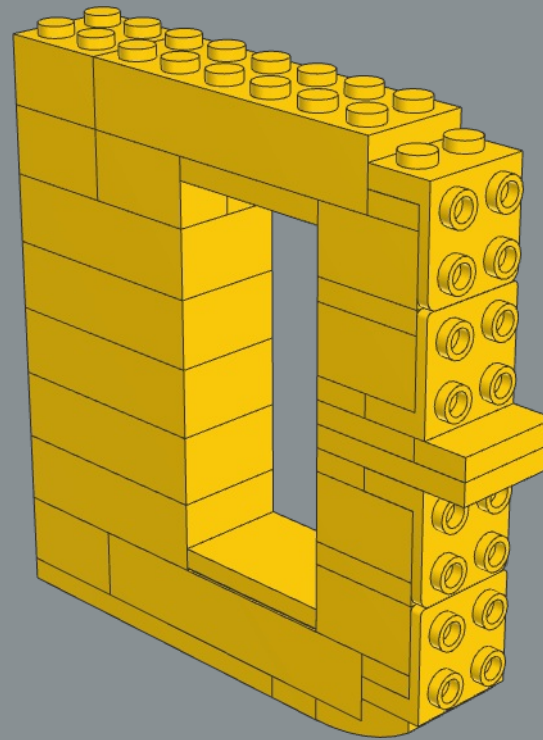
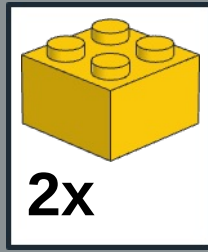

19

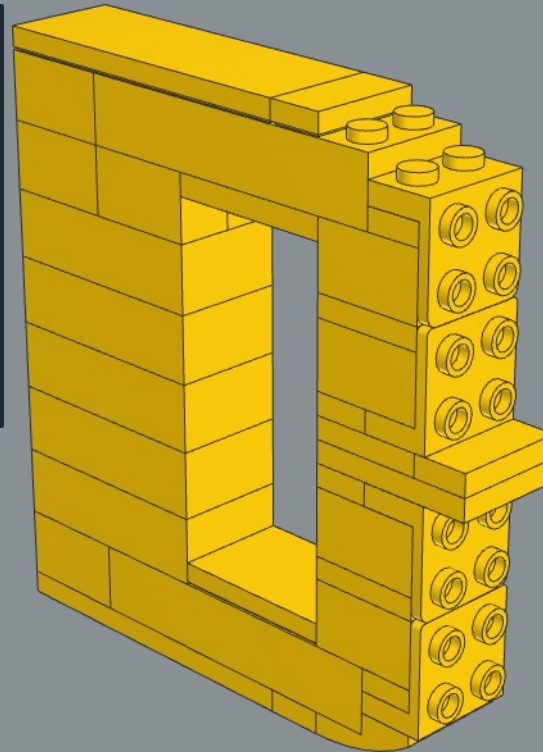
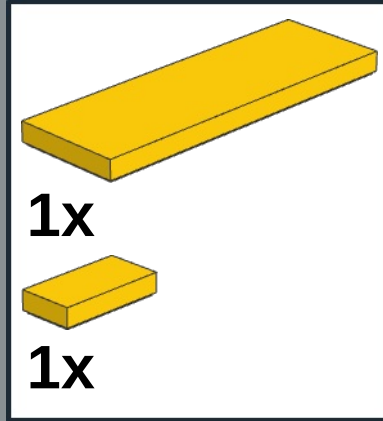

20

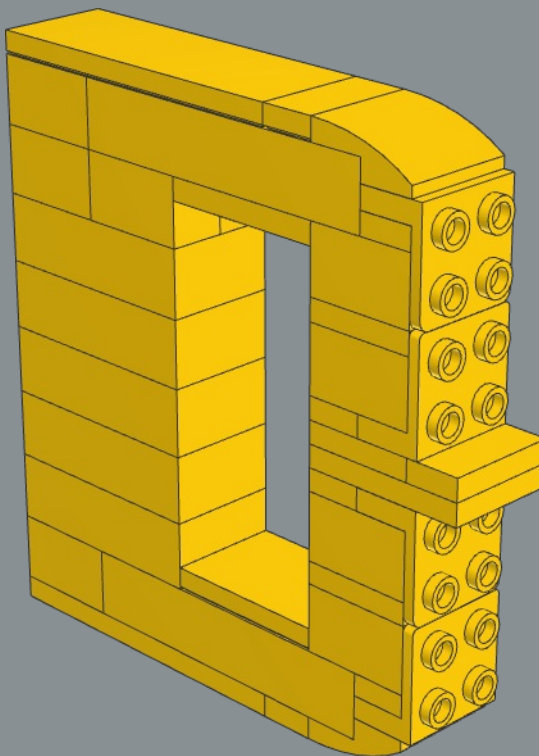
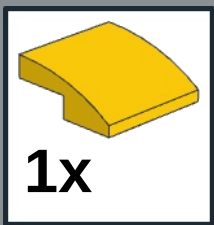

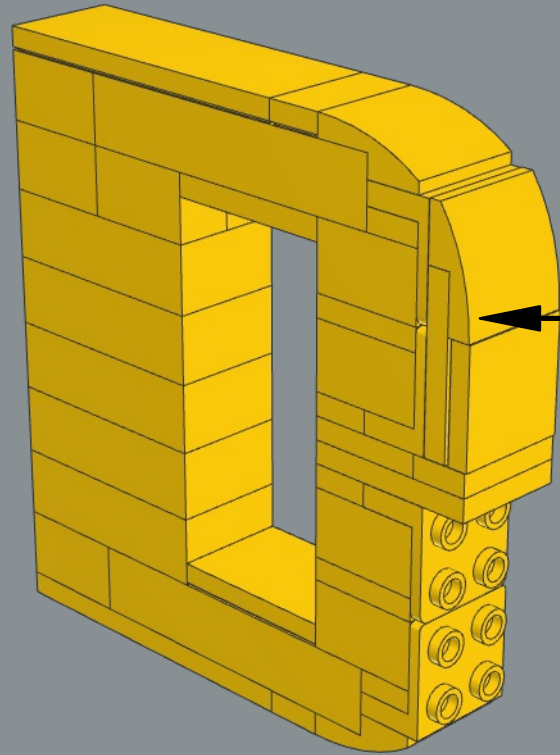

1

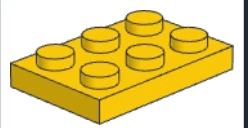

1x

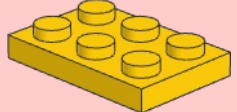

2

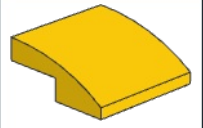

1x

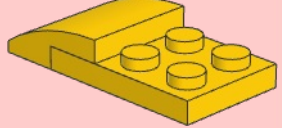

3

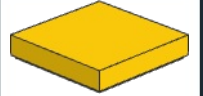

1x



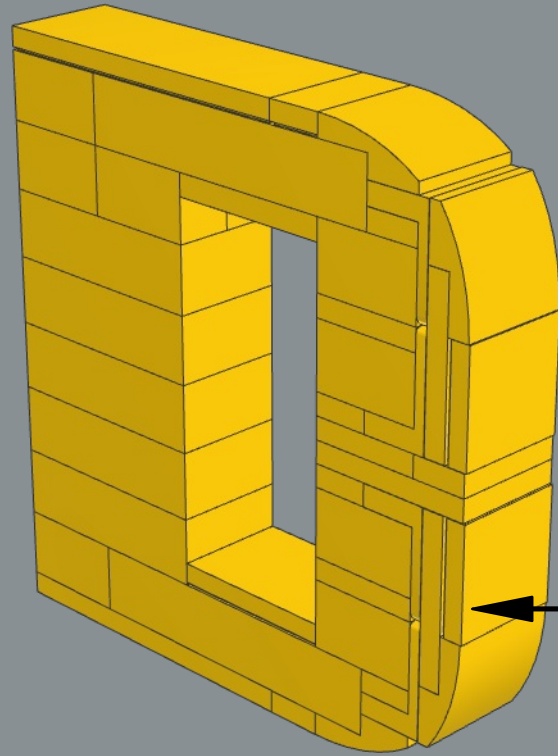

- 1**

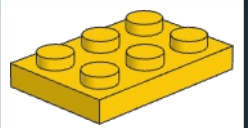

1x

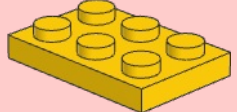
- 2**

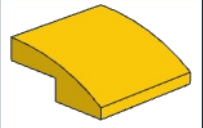

1x

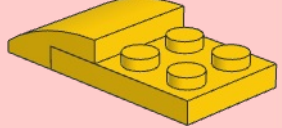

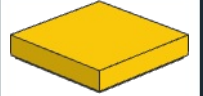
- 3**



1x

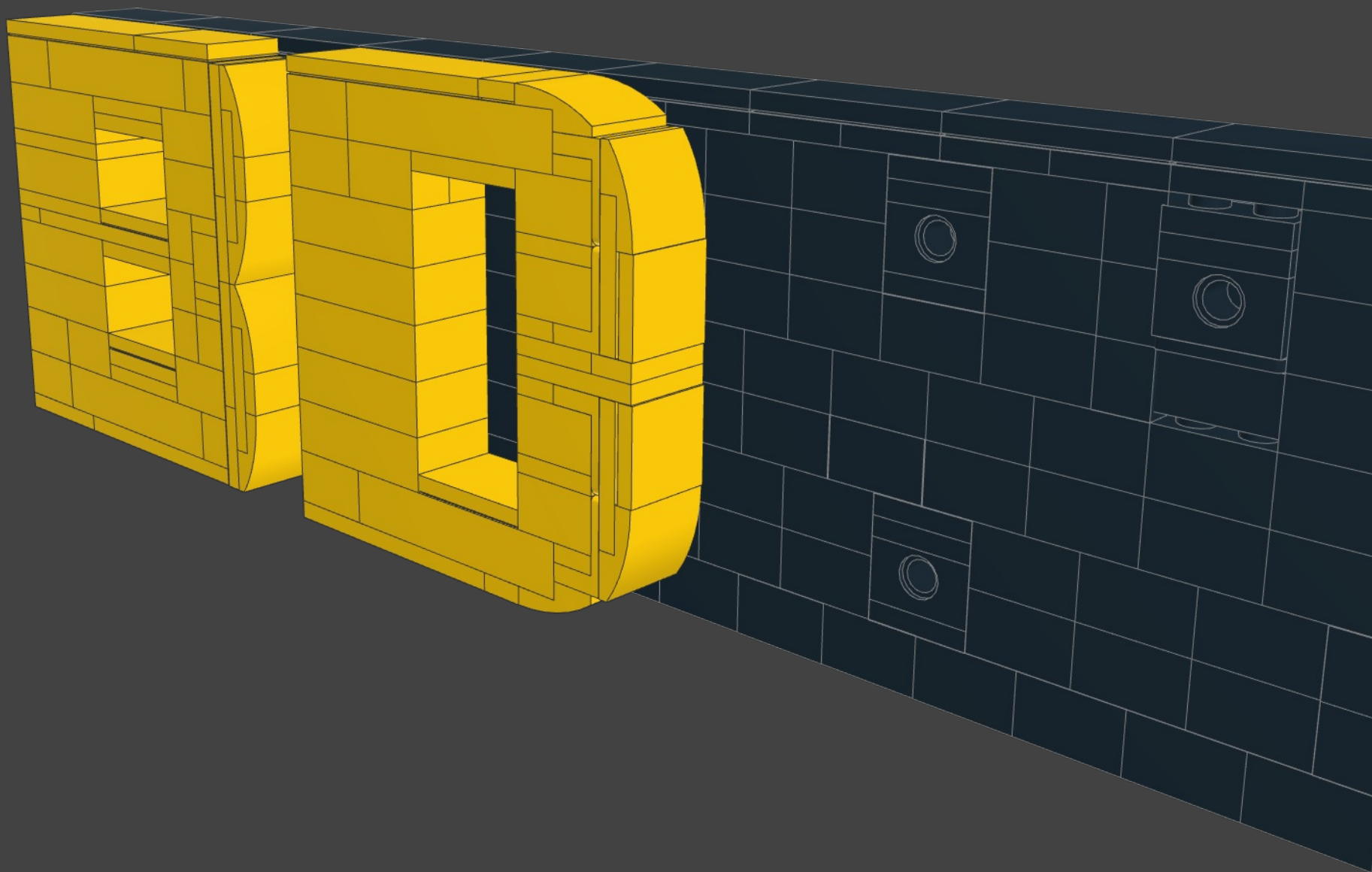

3



1

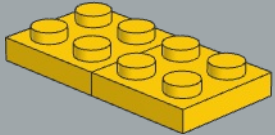
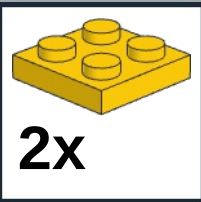

2

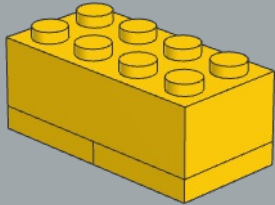
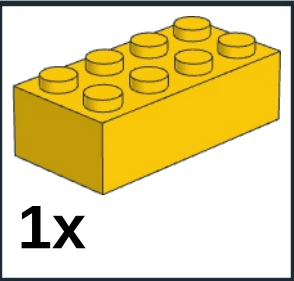

3

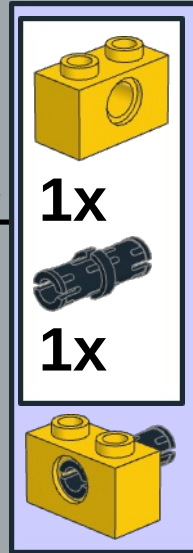
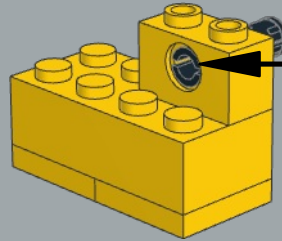

4

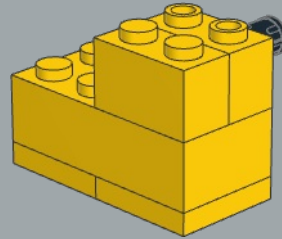

5

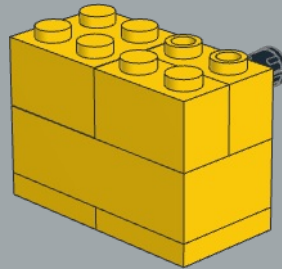

6

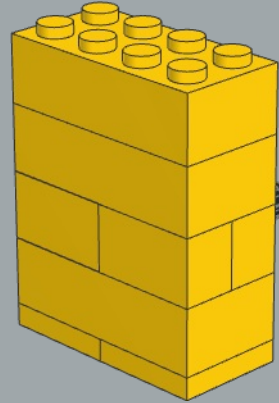
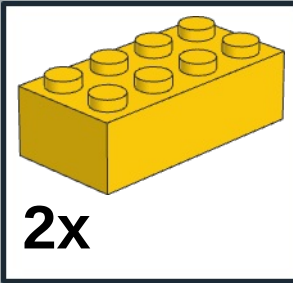

7

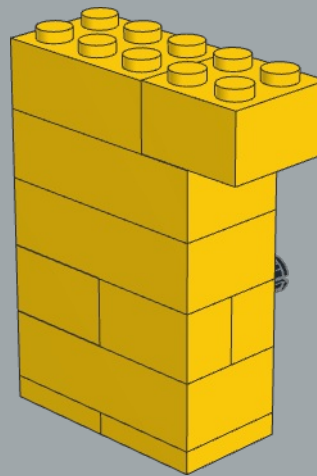
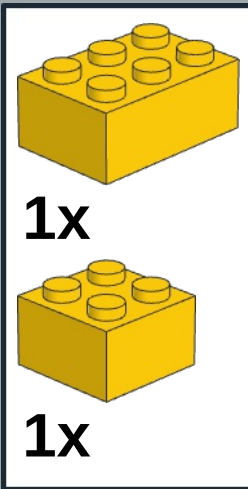

8

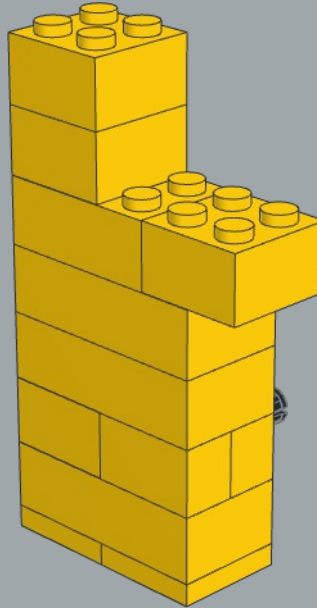
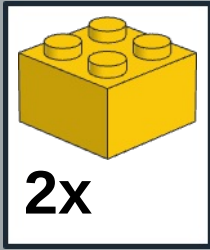

9

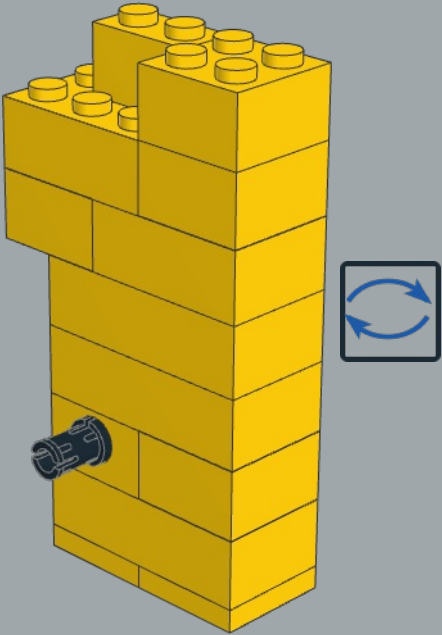
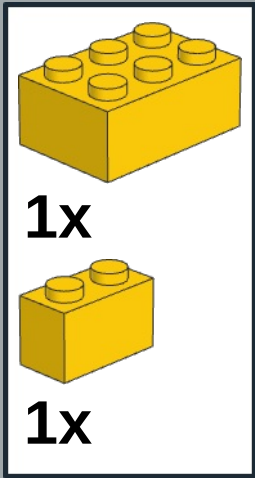

10

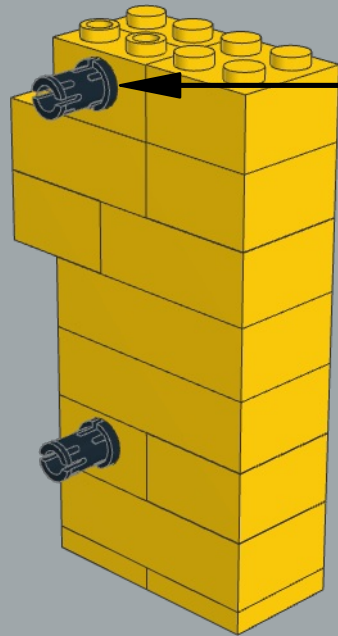

1x

1x

11

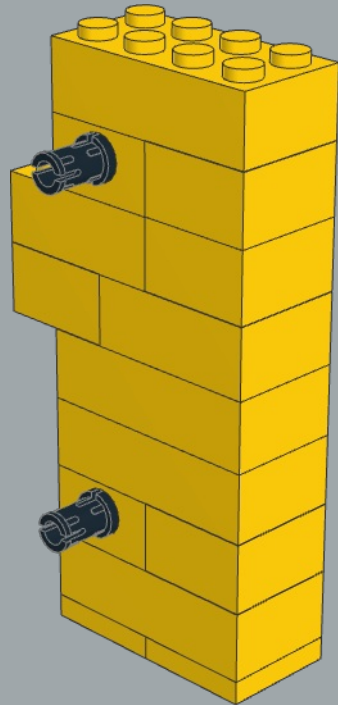

12

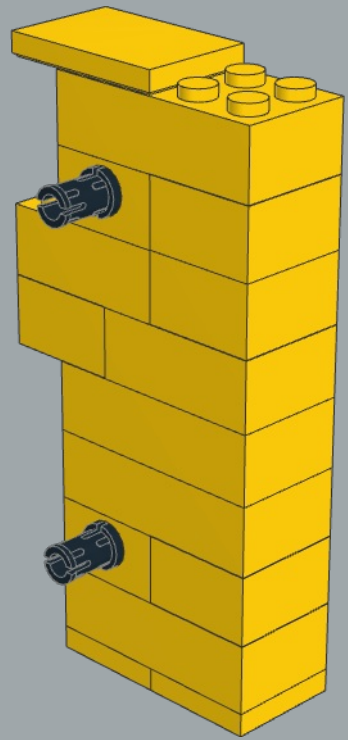
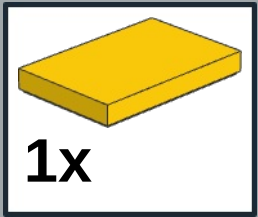

13

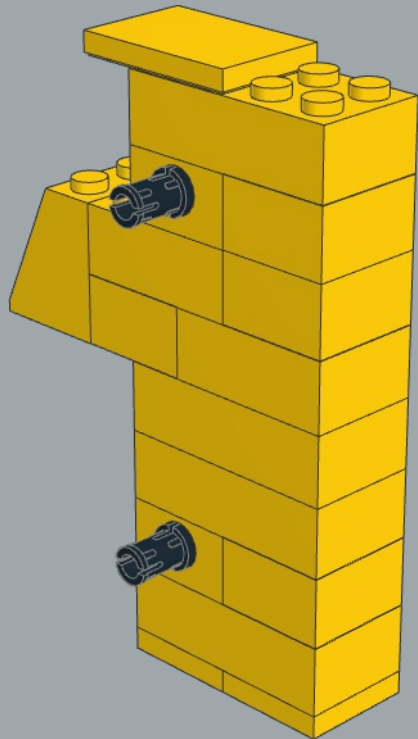

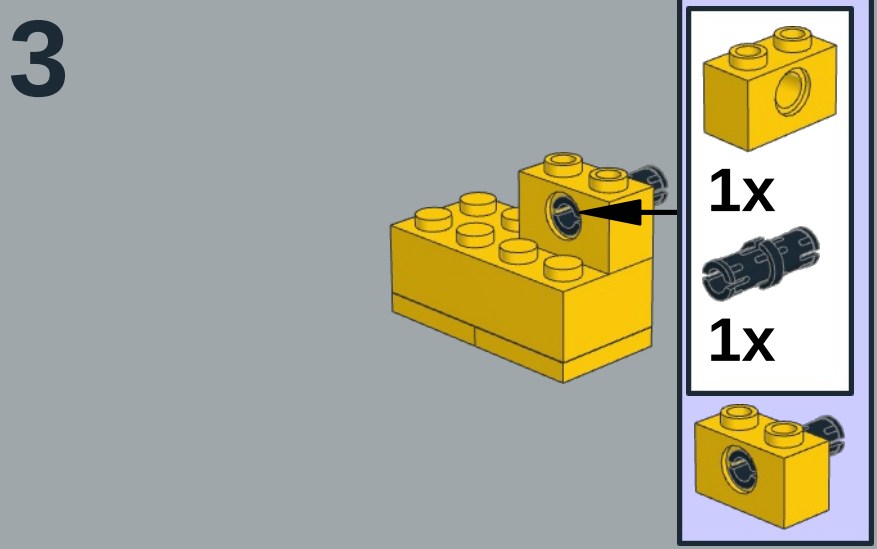
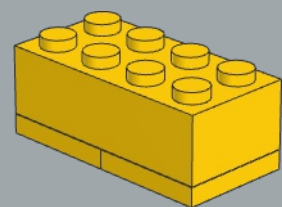
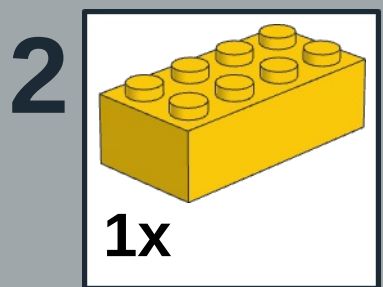
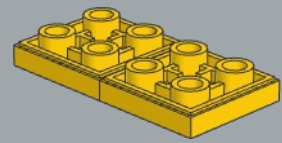
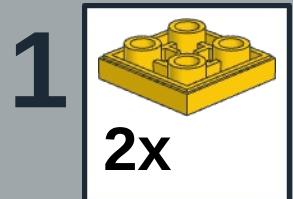

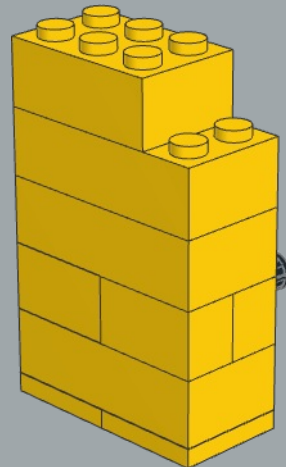
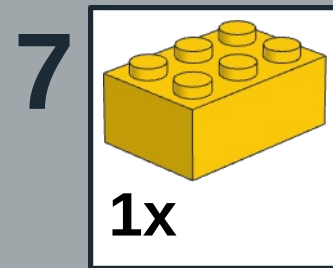
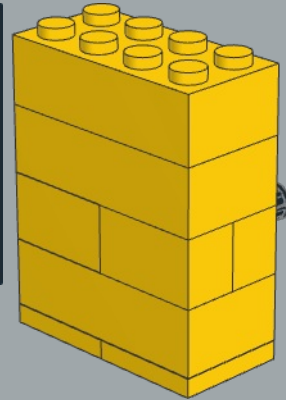
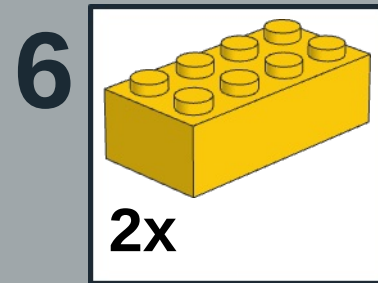
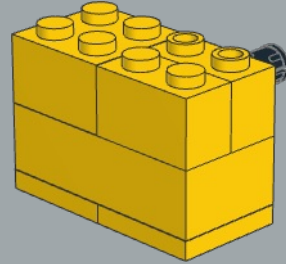
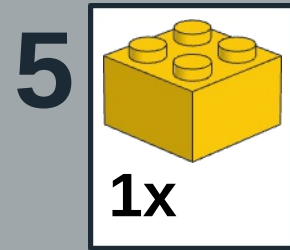
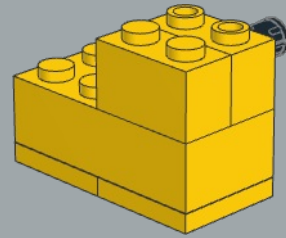
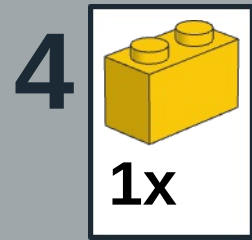

8

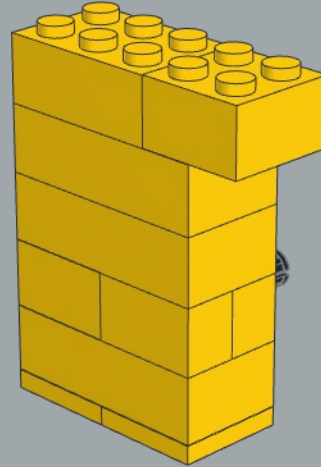
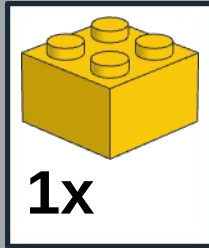

9

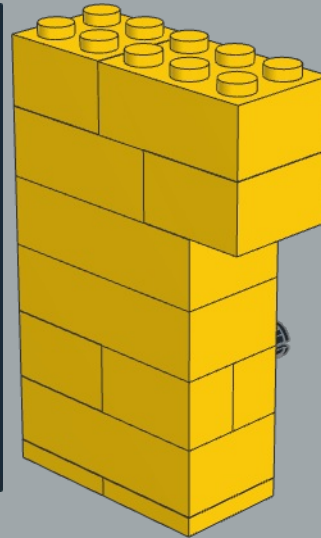
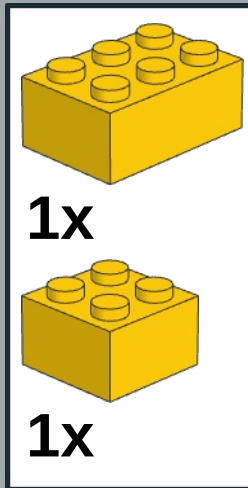

10

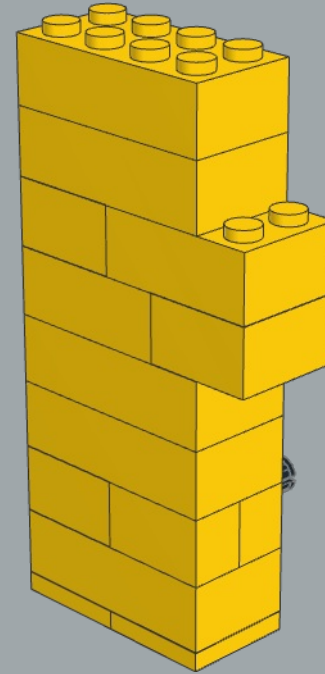
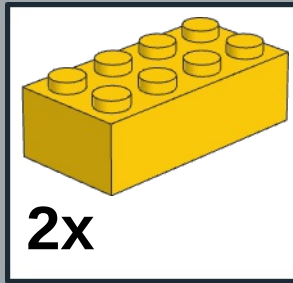

11

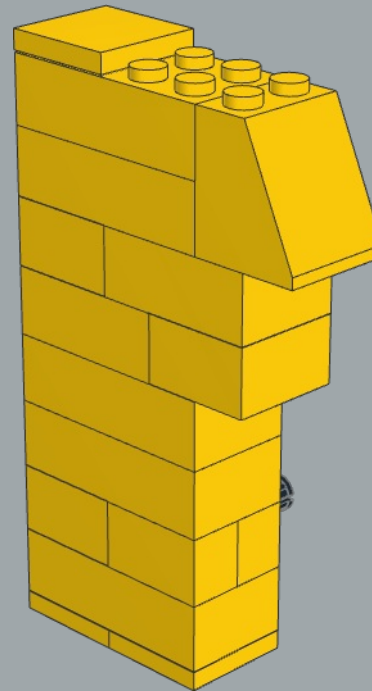
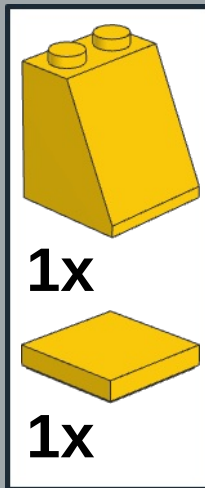

12

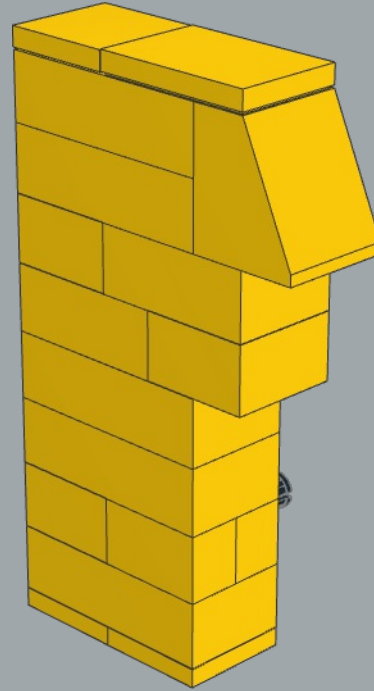
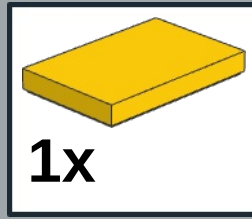

13

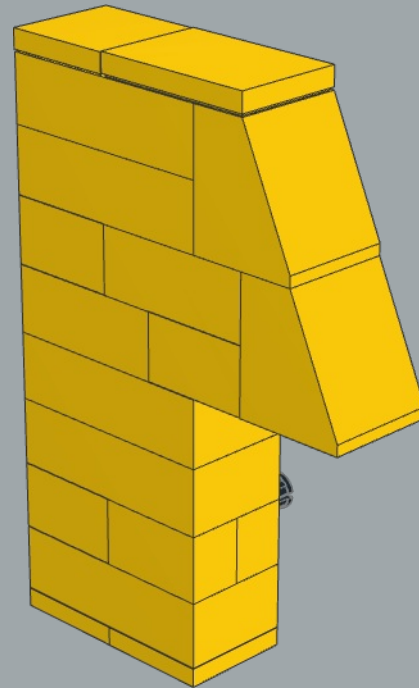
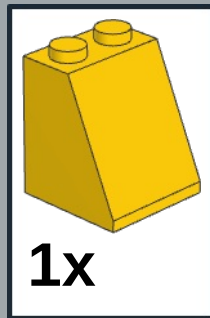

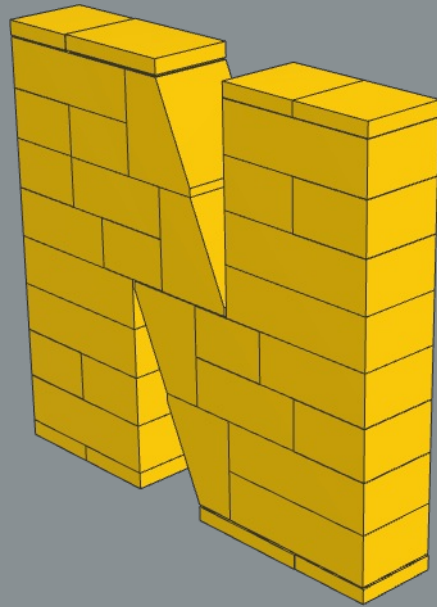

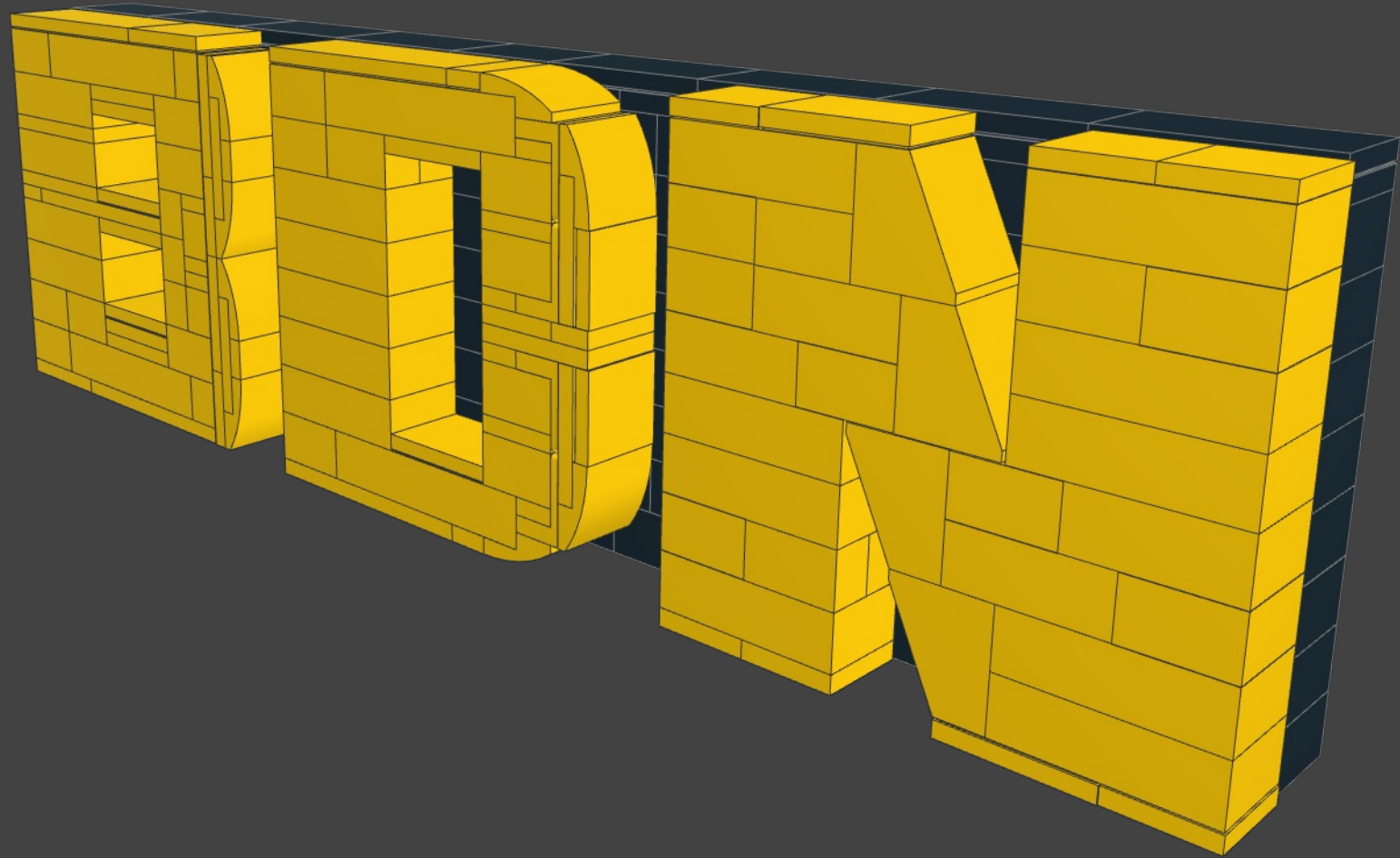

1

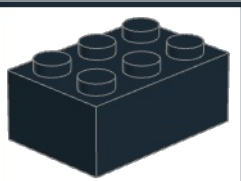

1x

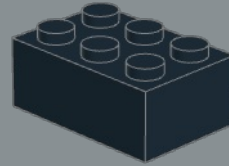

2

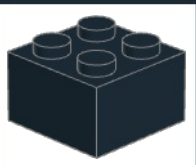

2x

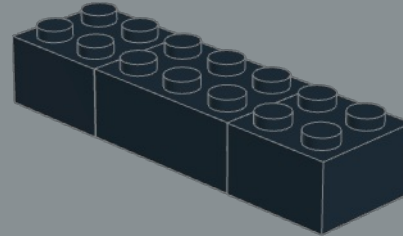

3

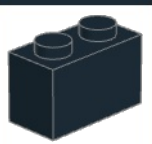

2x

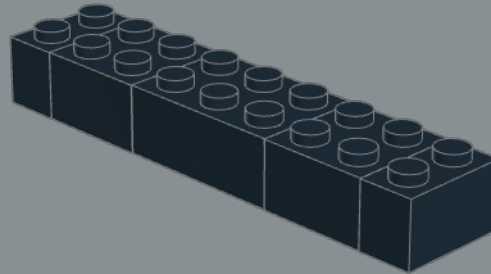

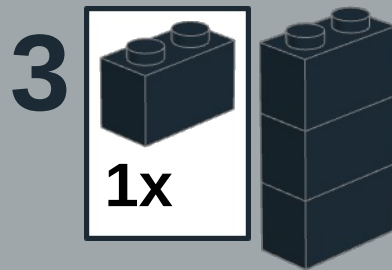
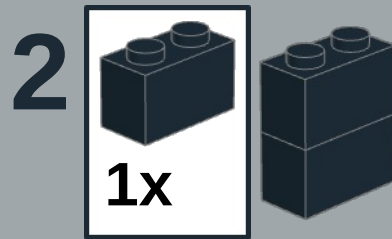
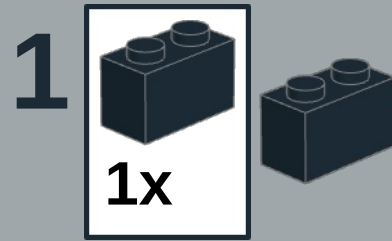

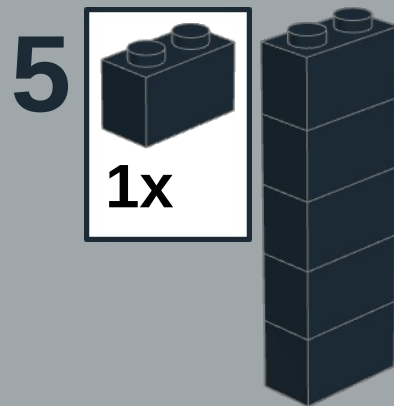
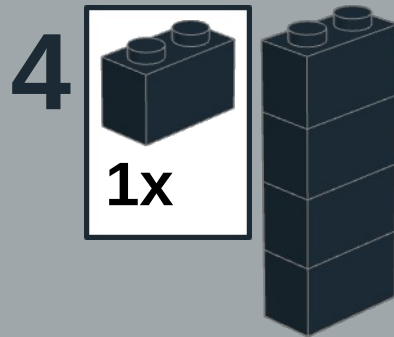

4

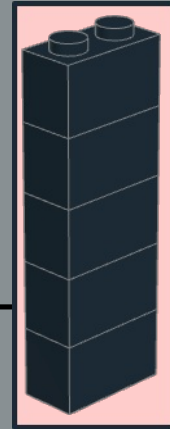
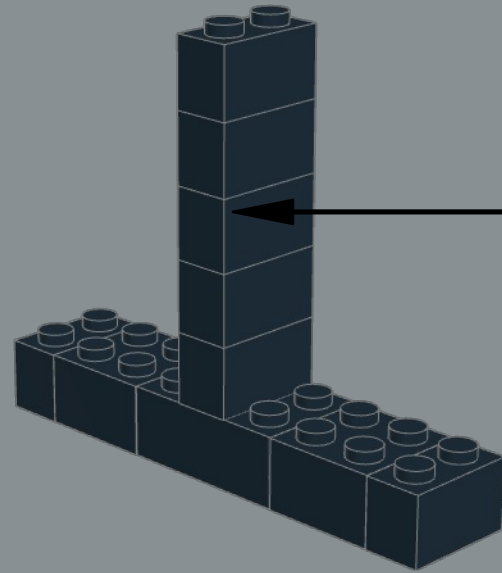

5

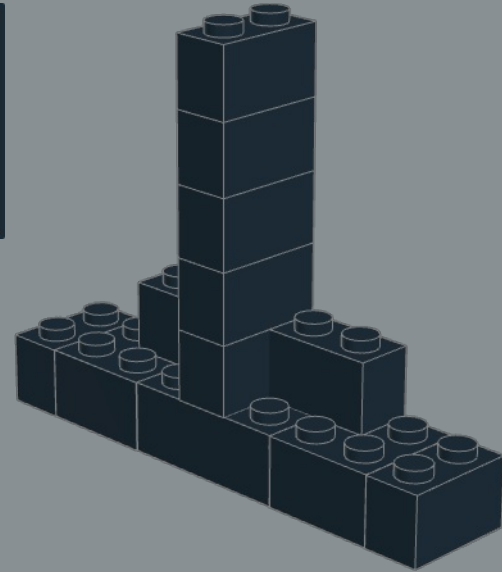
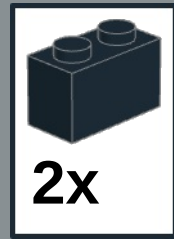

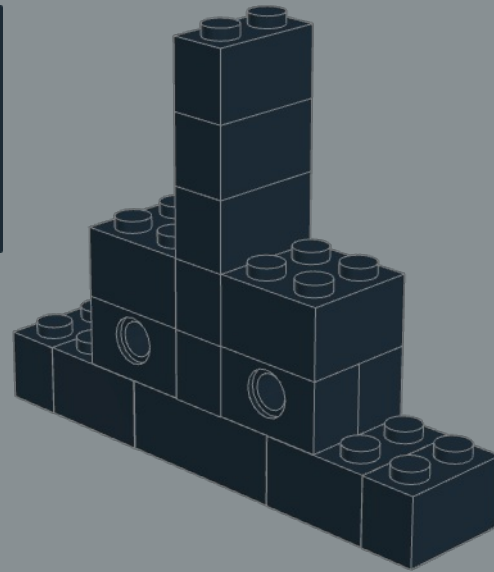
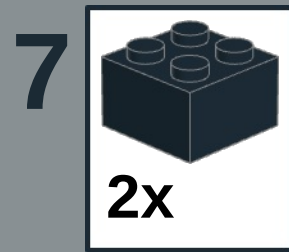
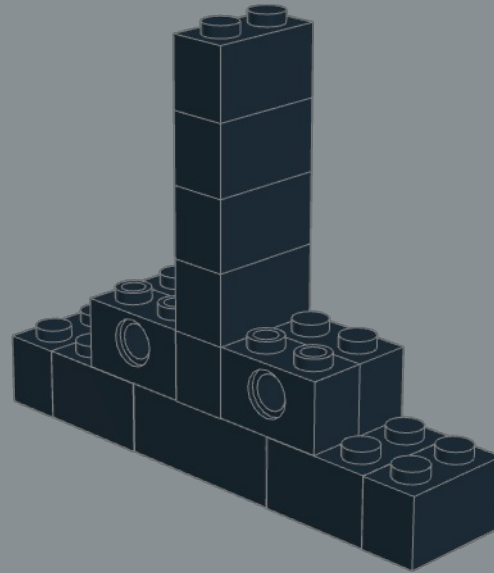

8

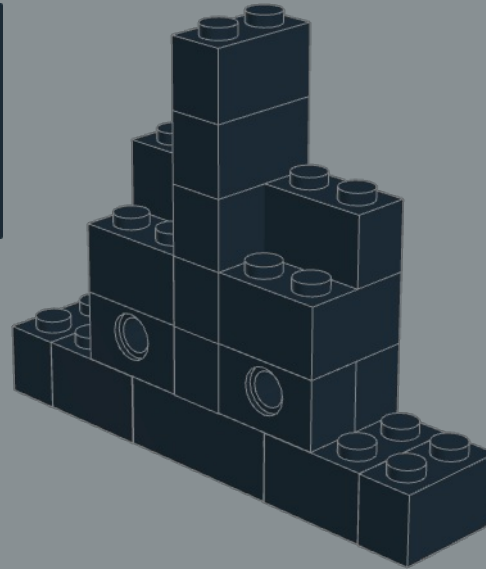
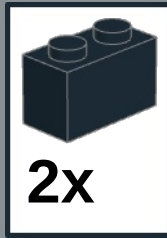

9

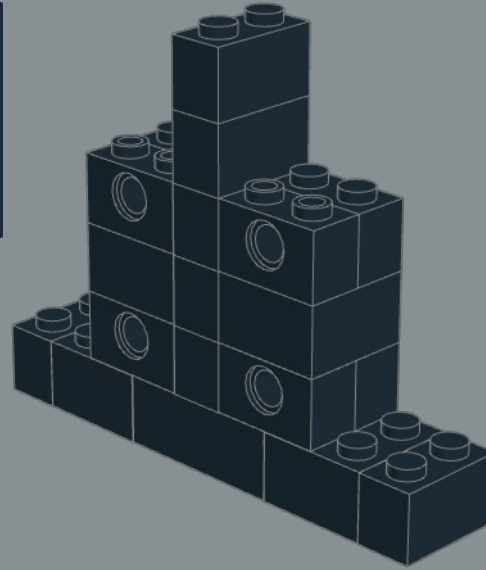
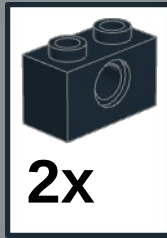

10

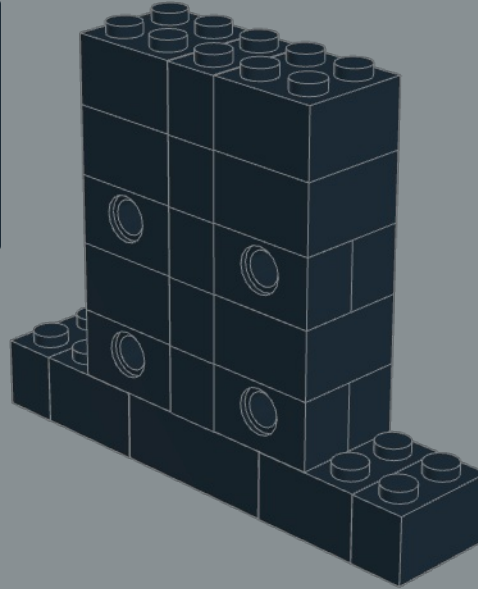
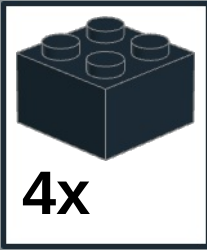

11

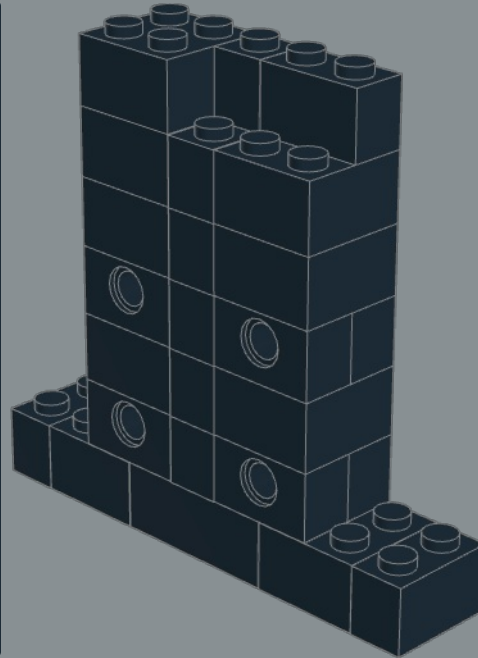
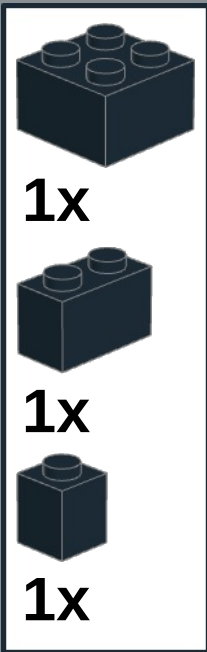

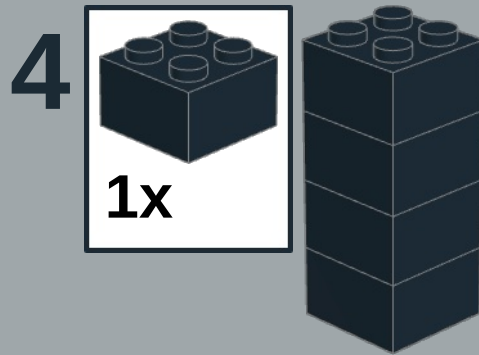
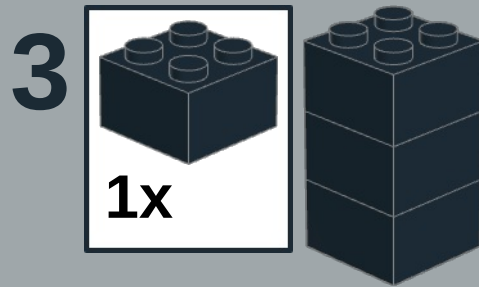
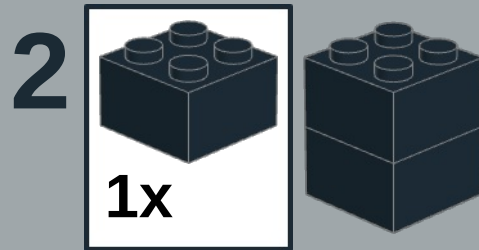
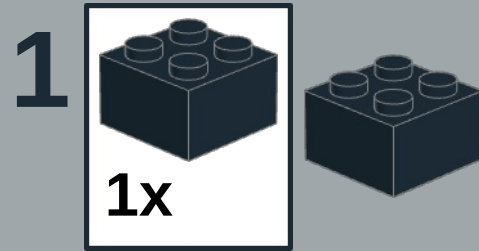

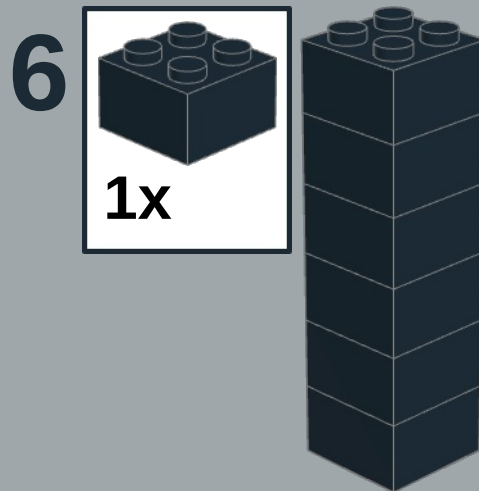
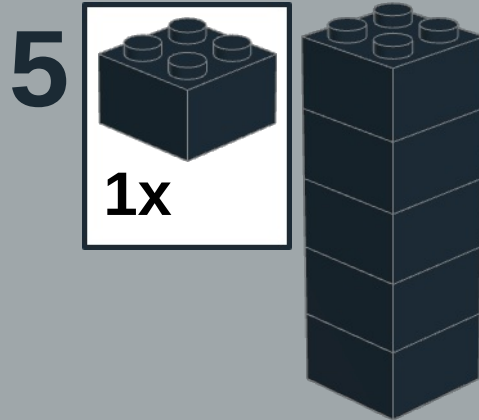

x2

12

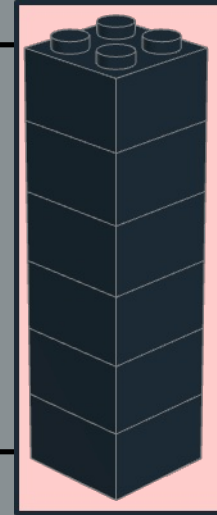
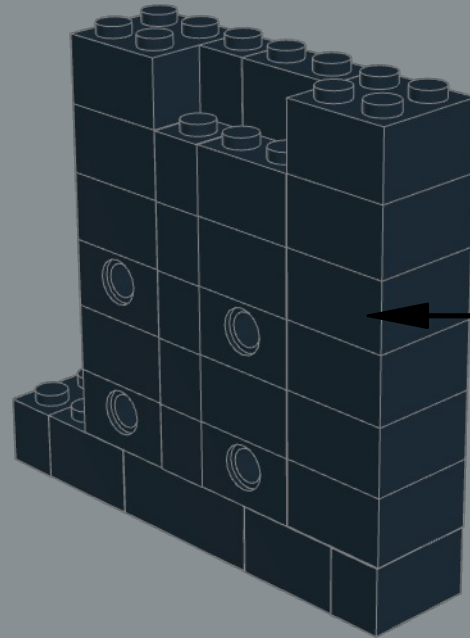

13



14

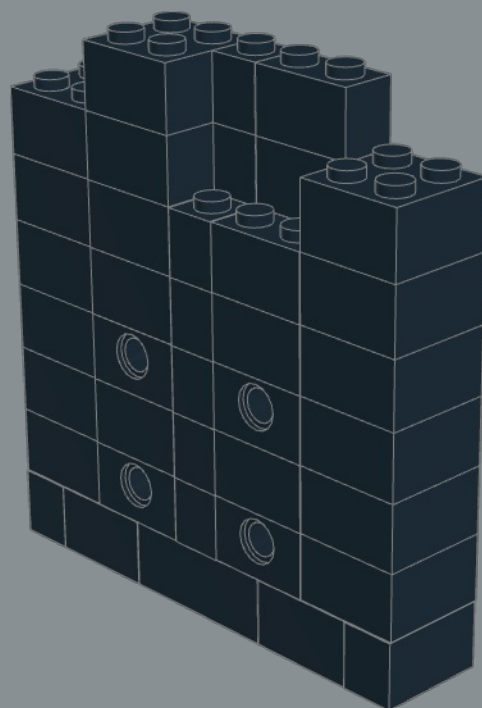
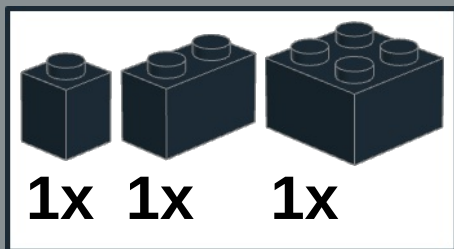

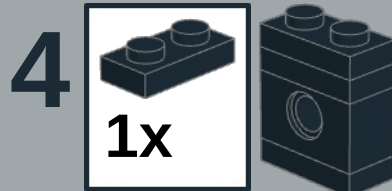
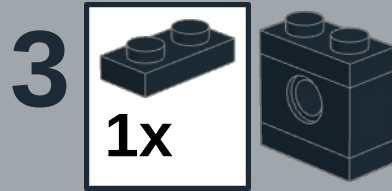
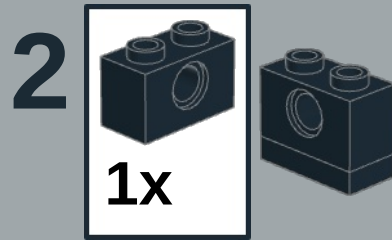
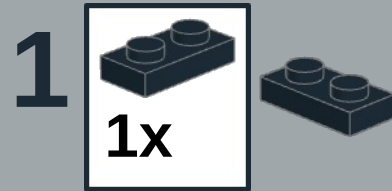

x1

15

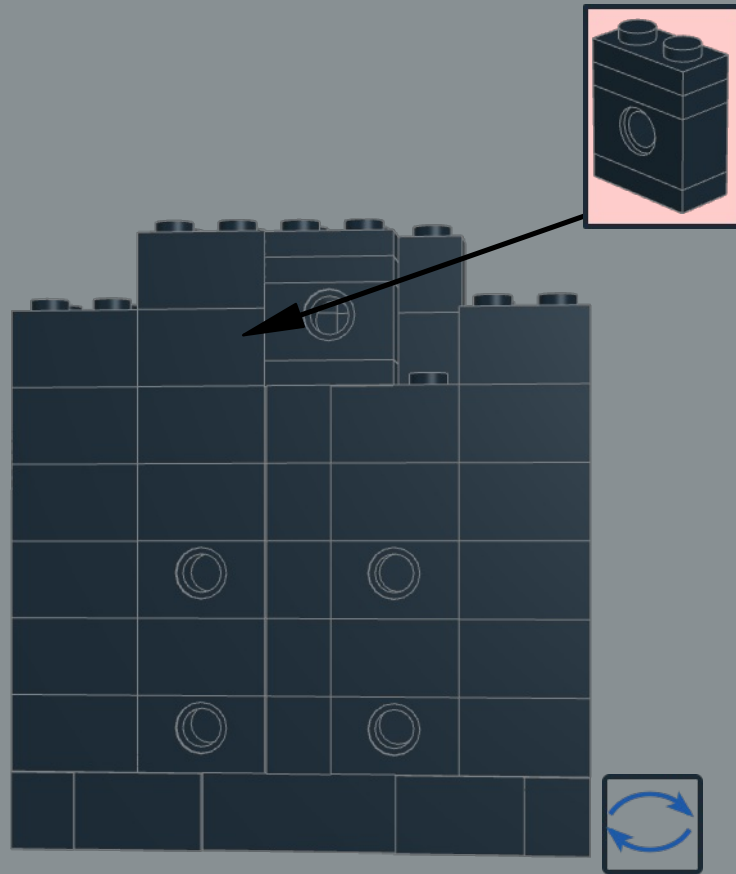

16

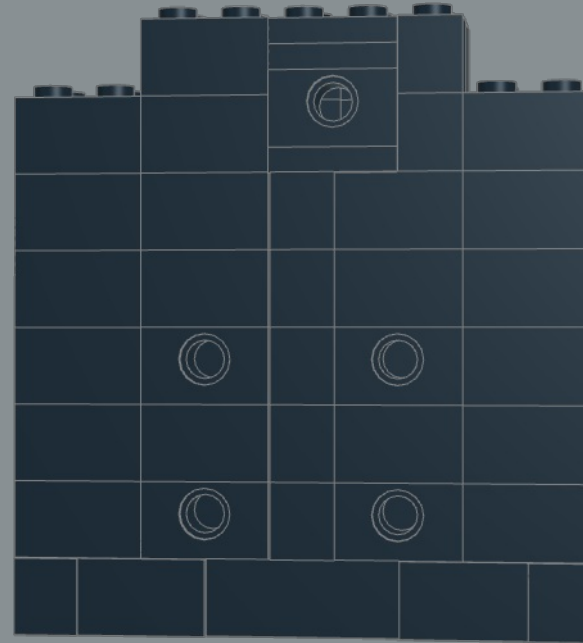

17

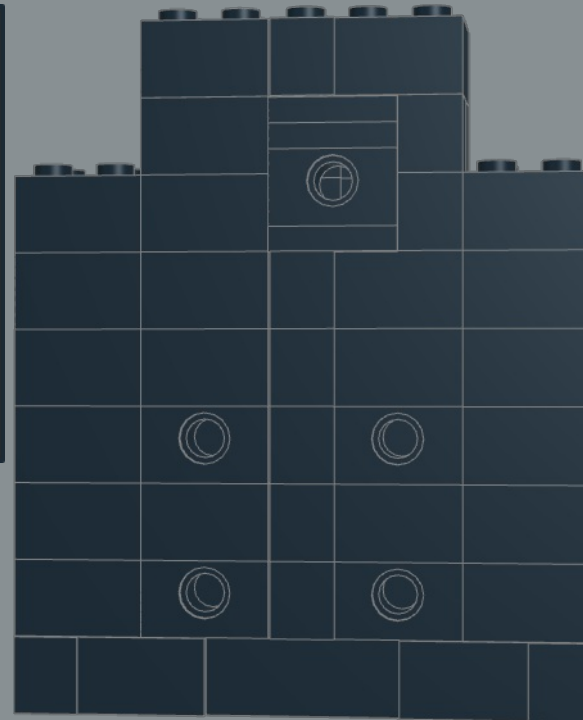
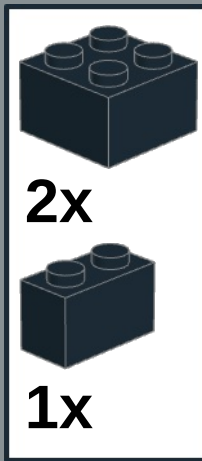

18

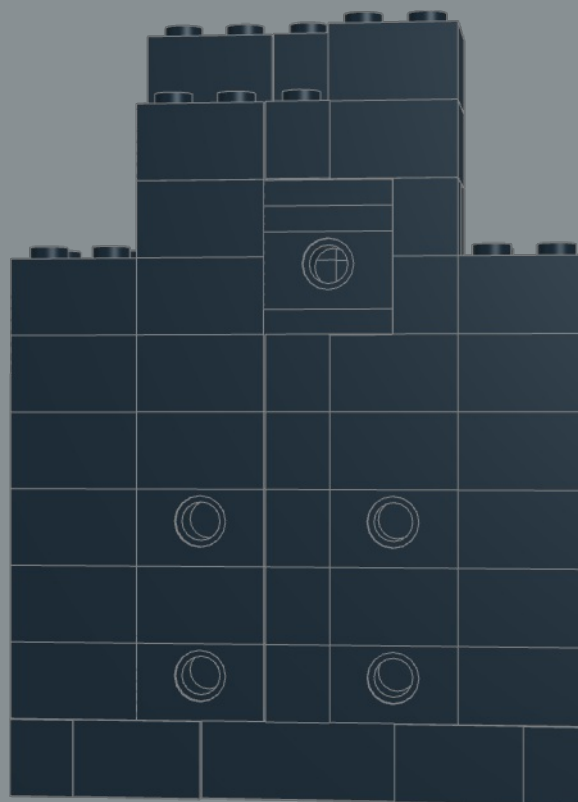
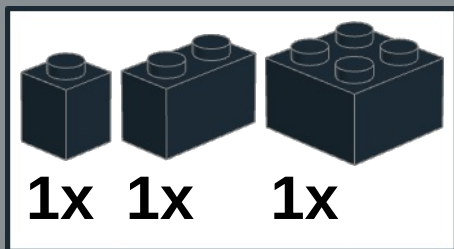

19

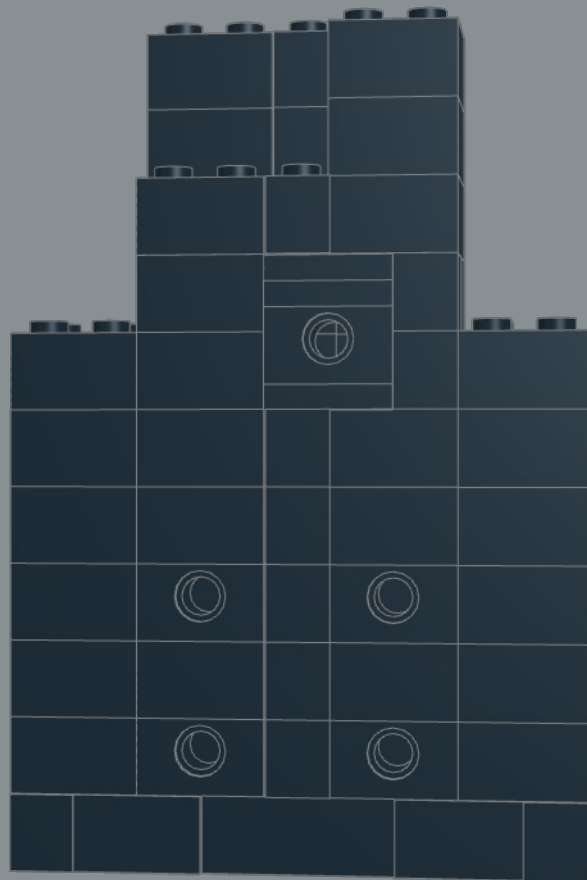
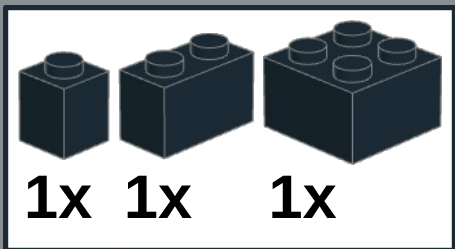

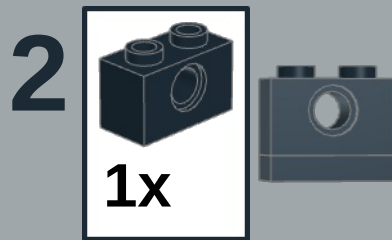
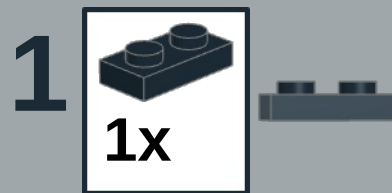

22

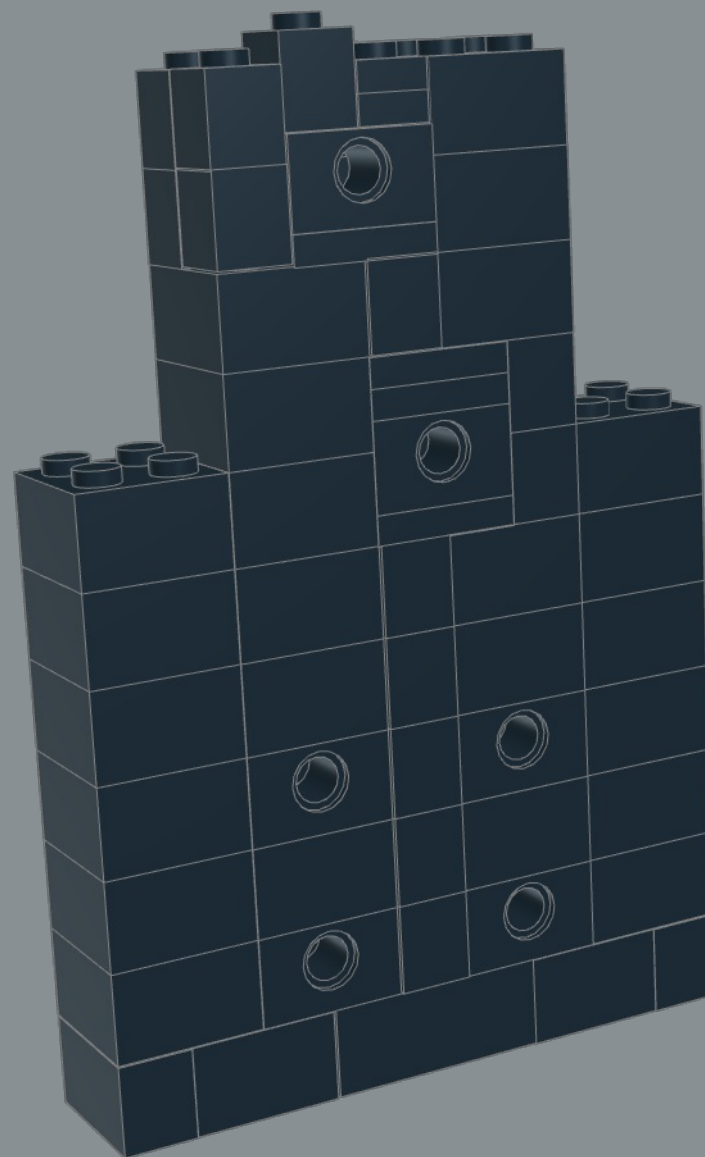

23

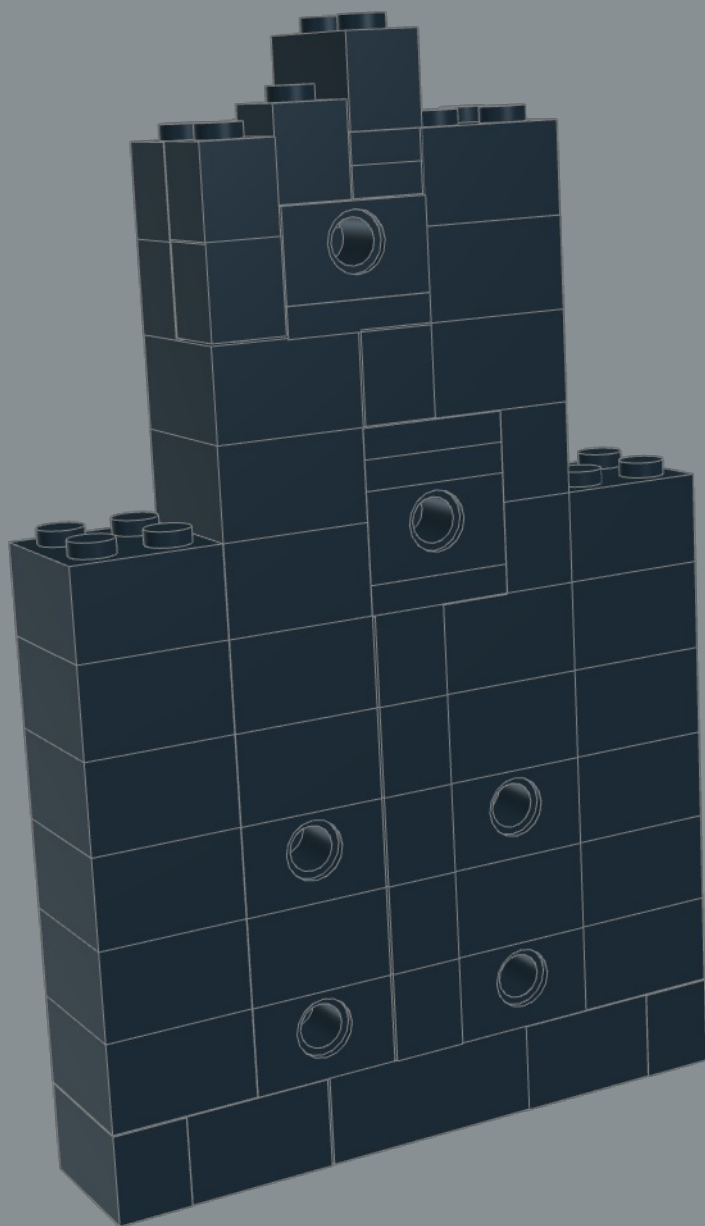
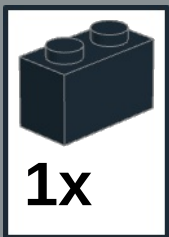

25

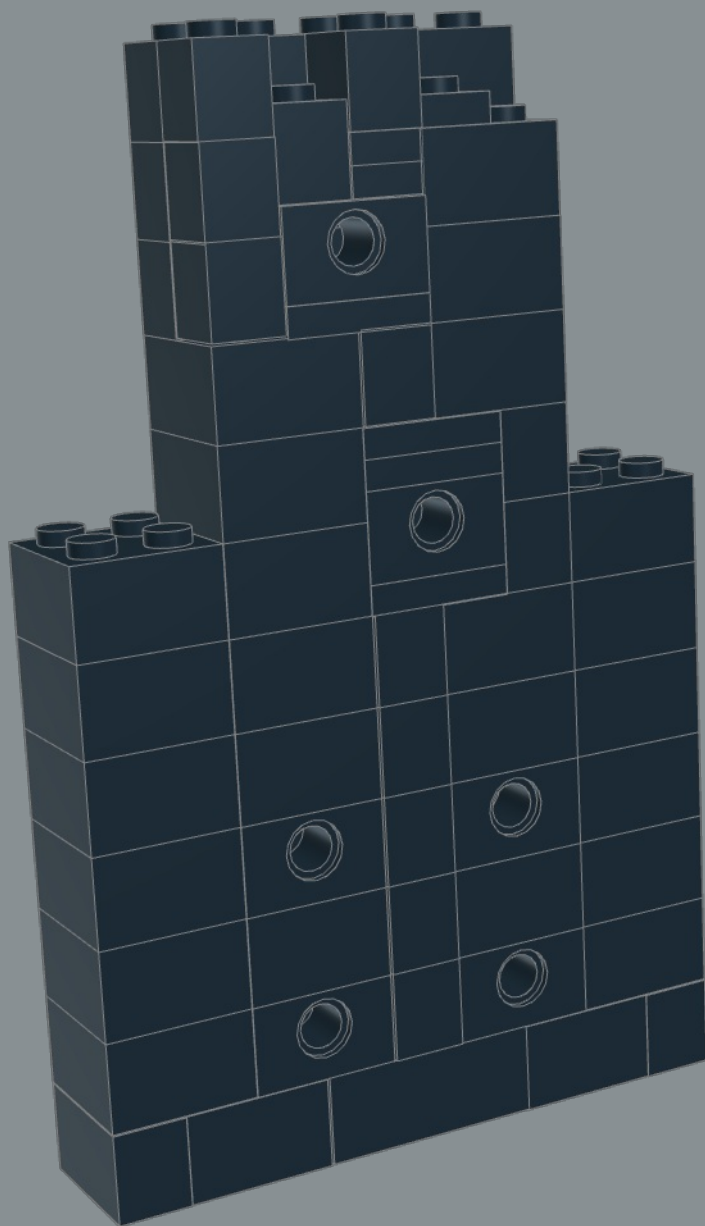
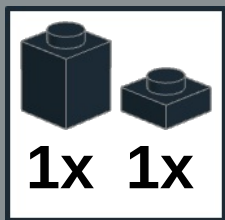

26

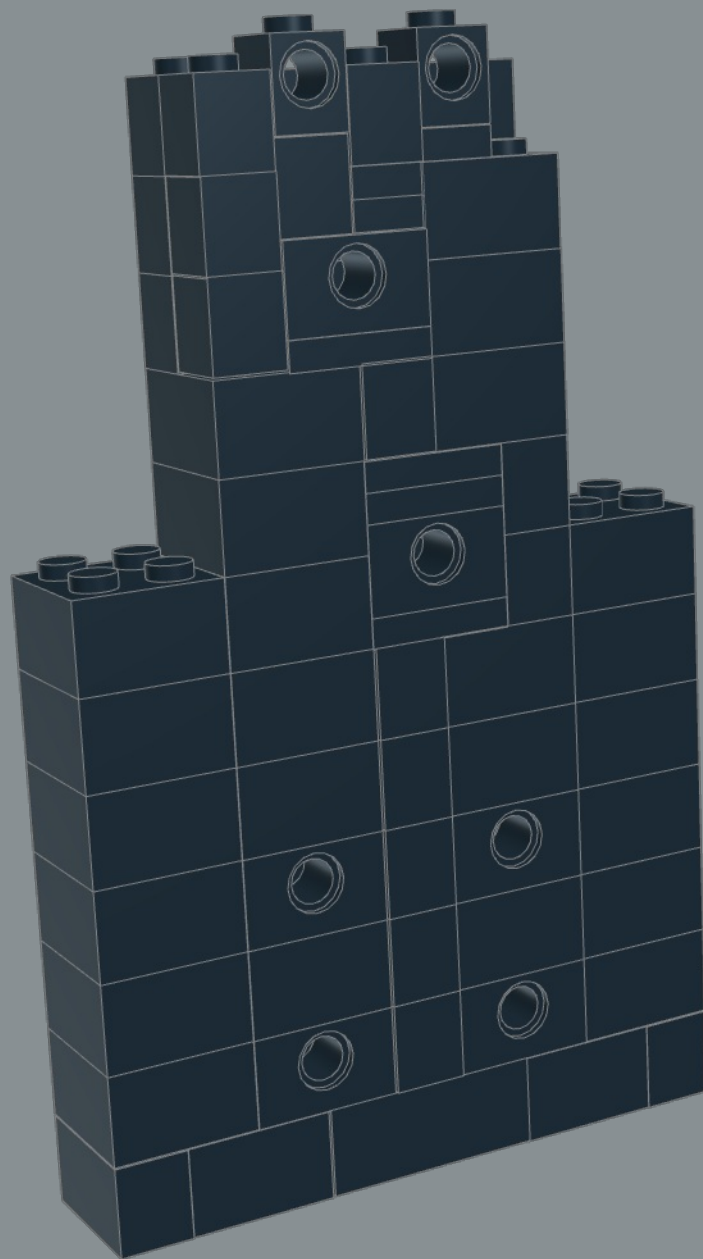

27

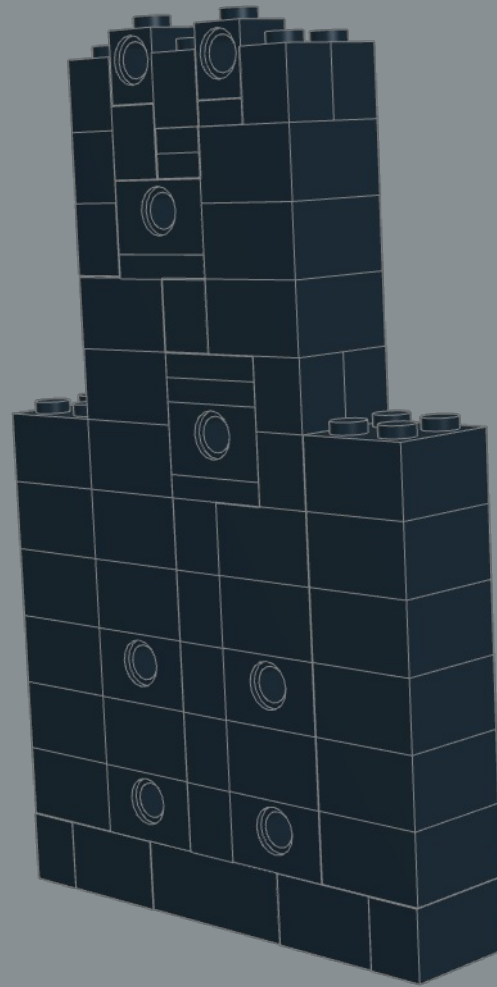

28

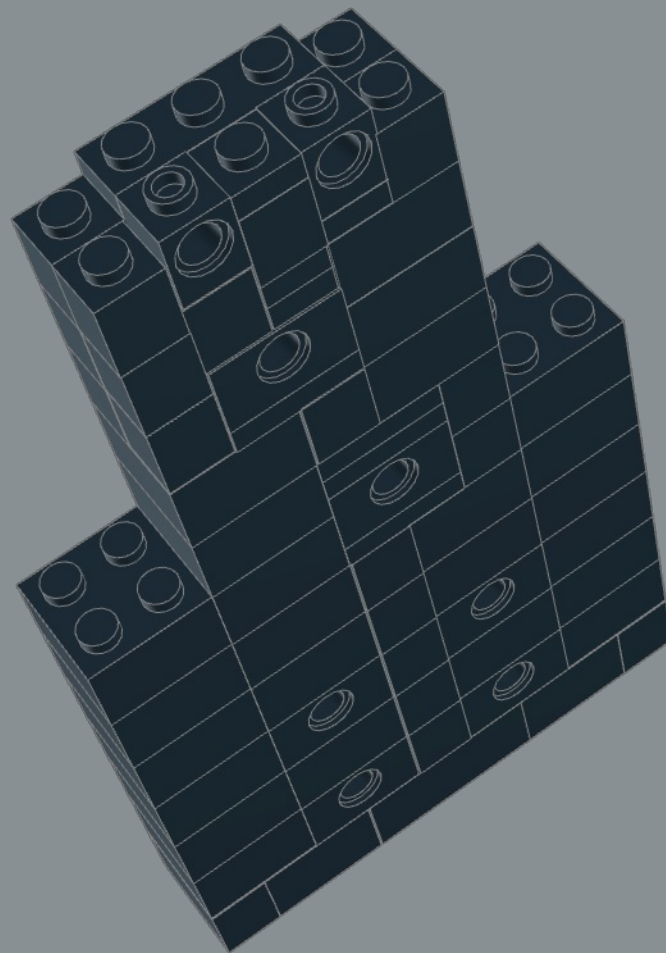
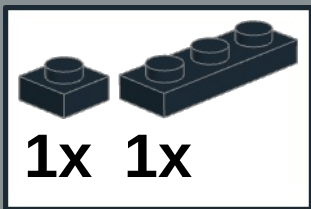

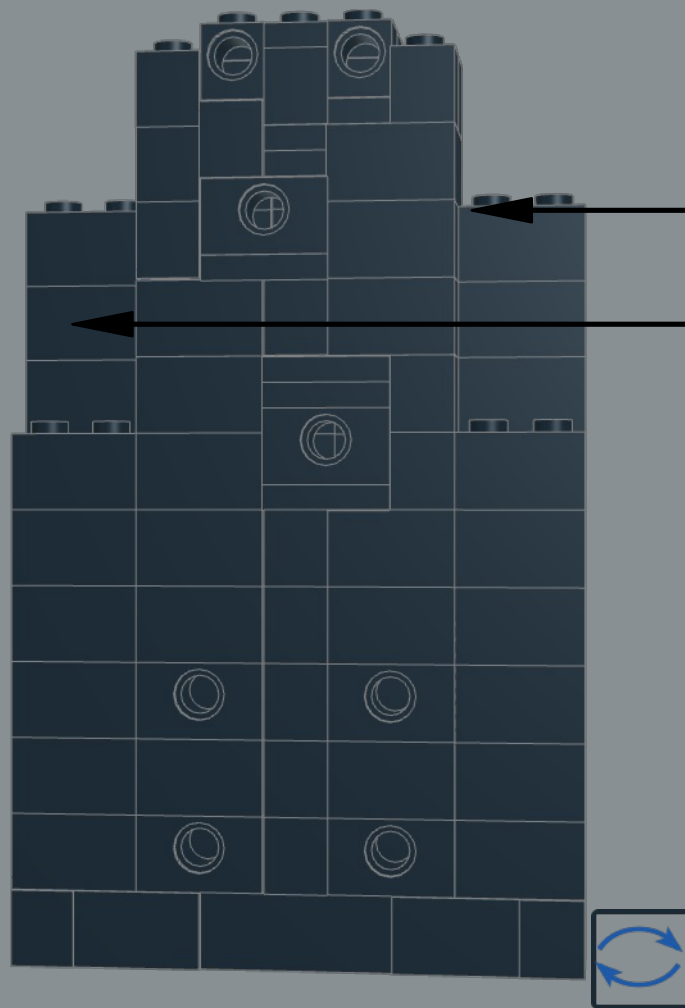

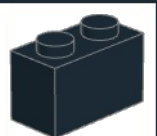
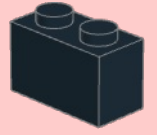
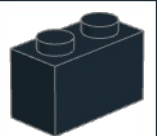
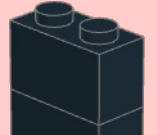
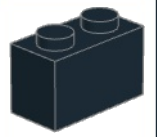
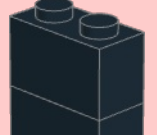
- 1  1x
- 
- 2  1x
- 
- 3  1x
-  x2

30

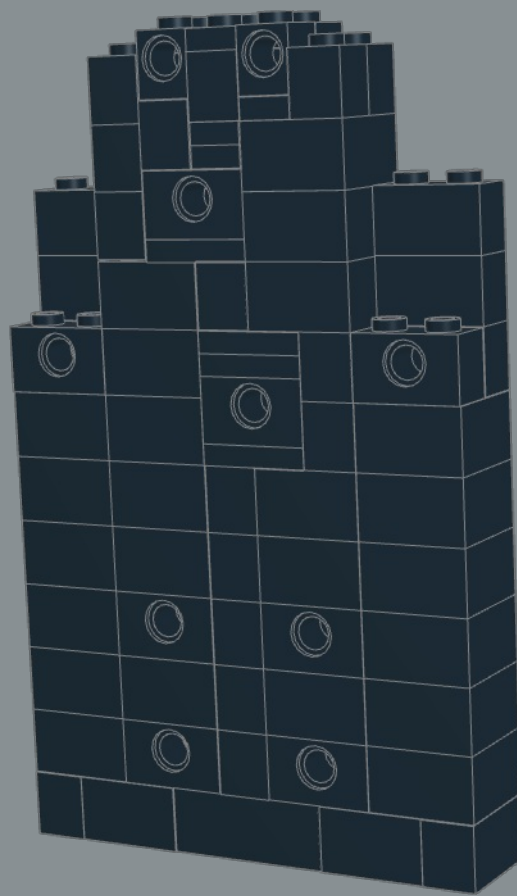
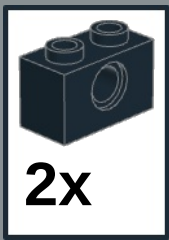

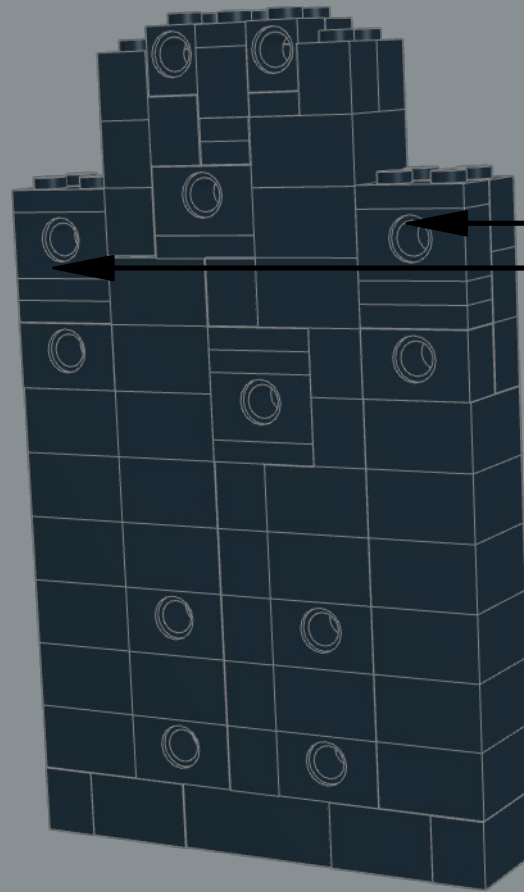

1

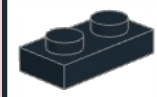

1x

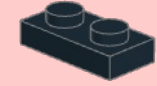

2

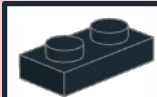

1x

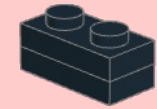

3

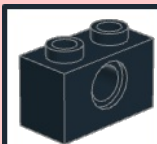

1x

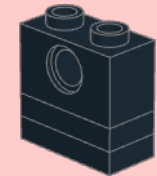

4



1x

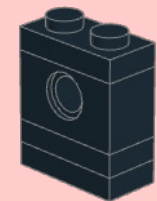

x2

32

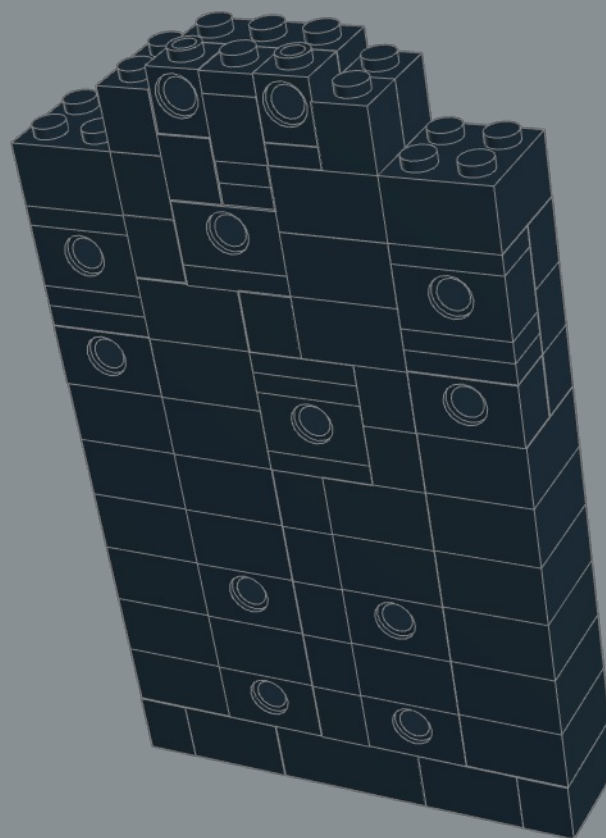
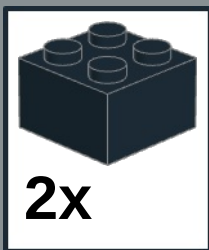

33

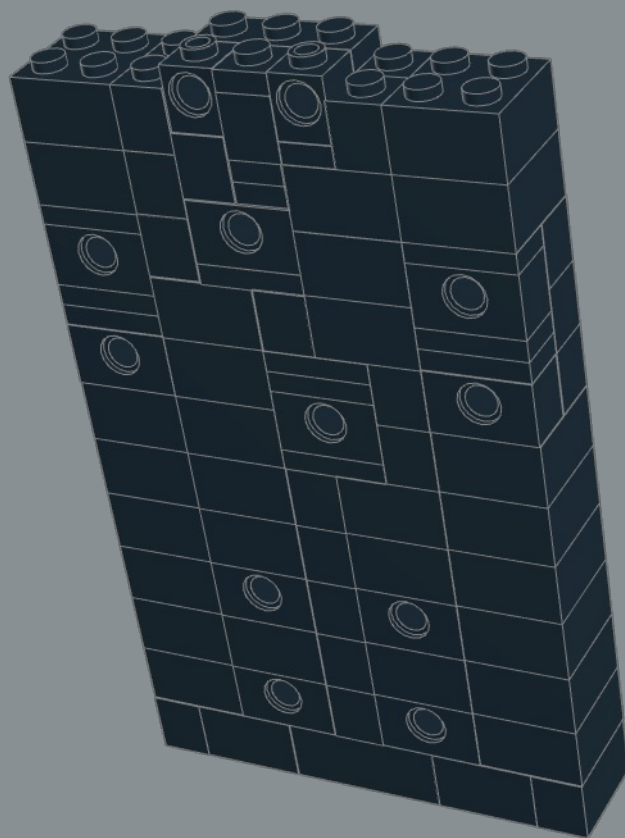
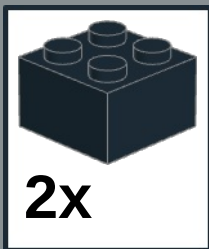

34

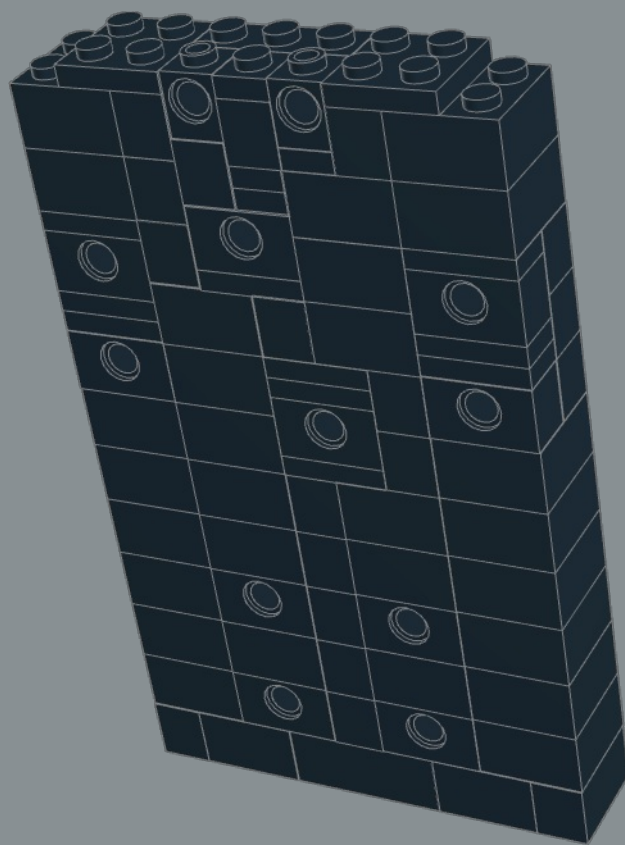
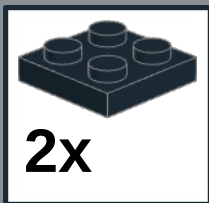

35

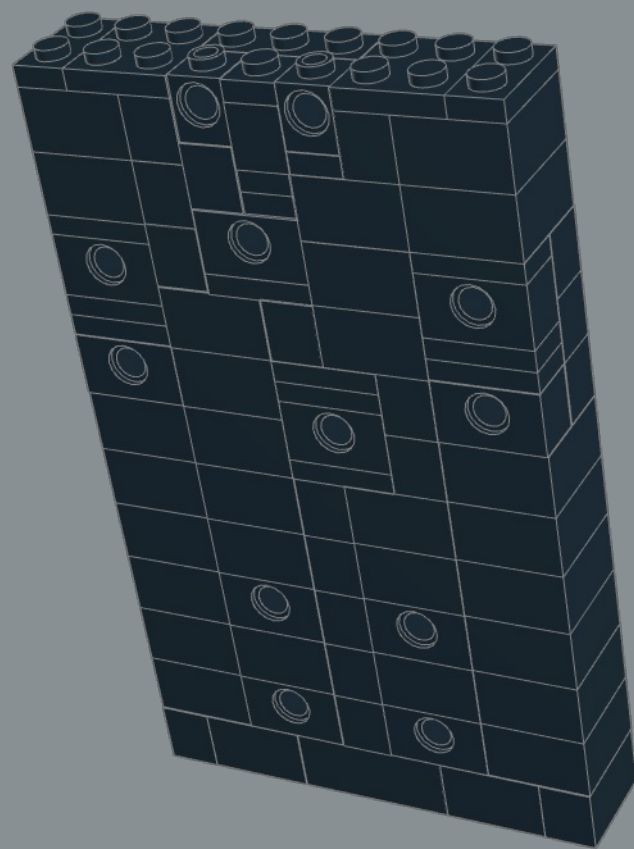

36

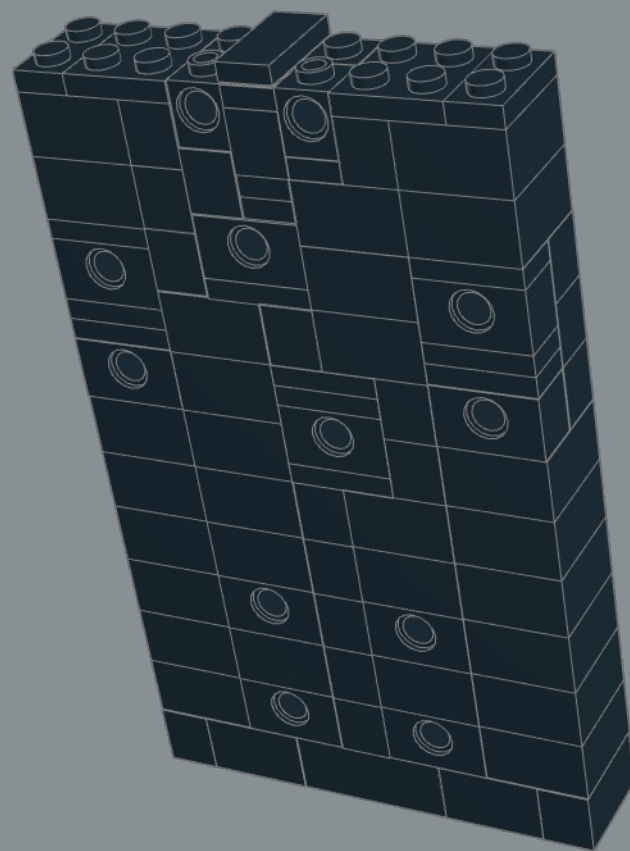
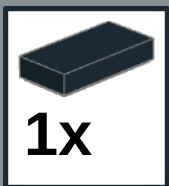

37

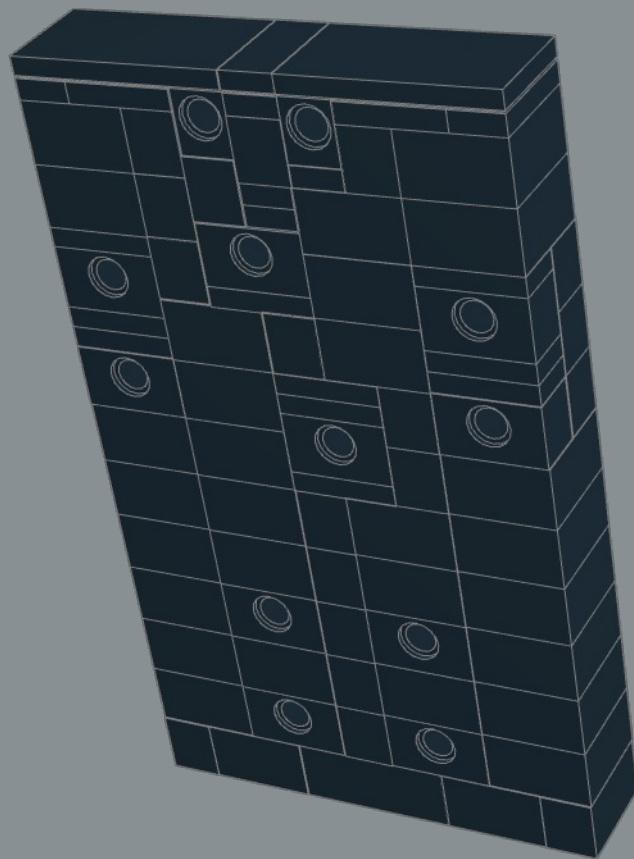
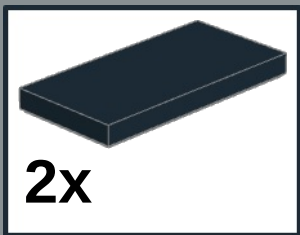

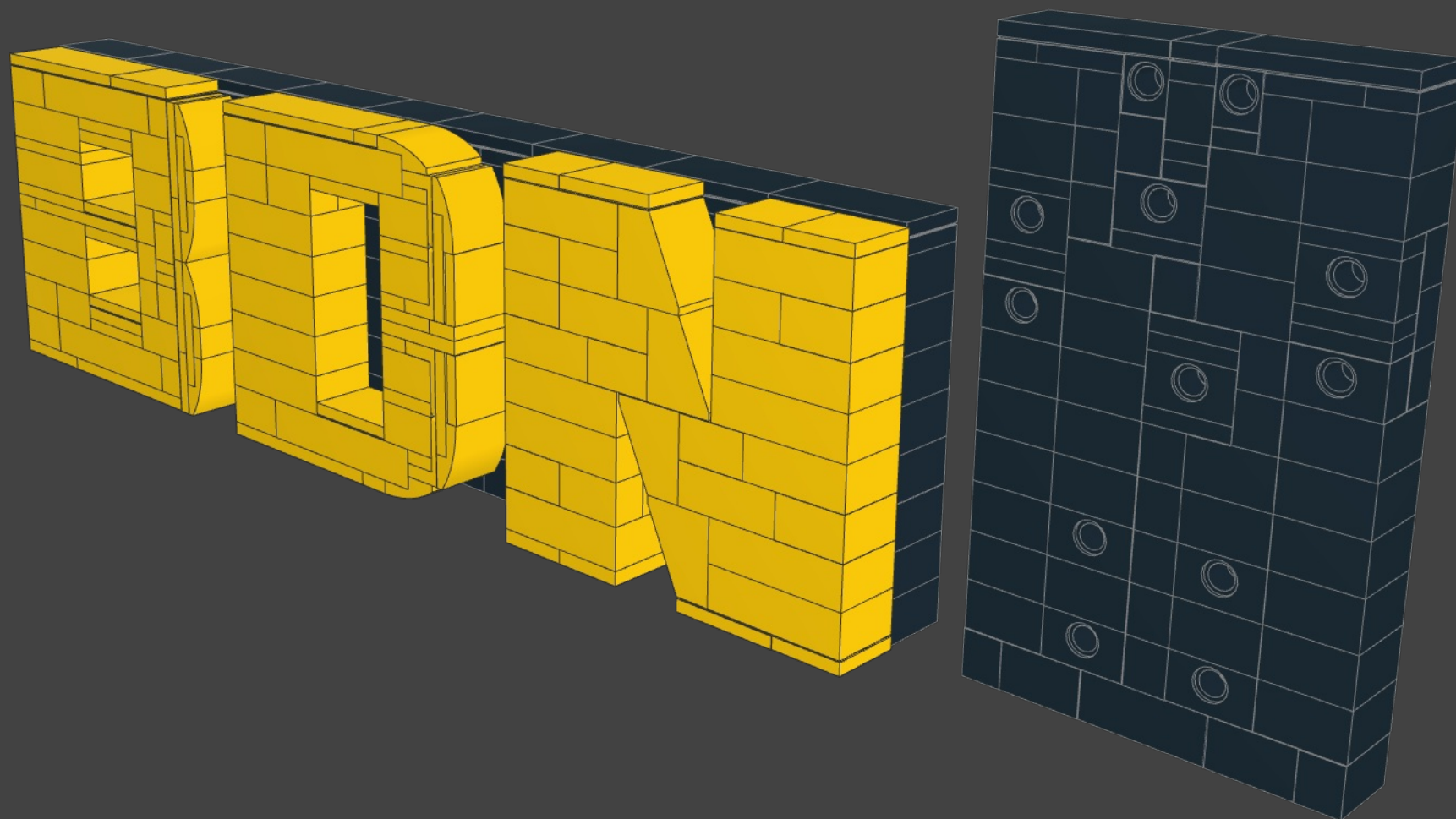

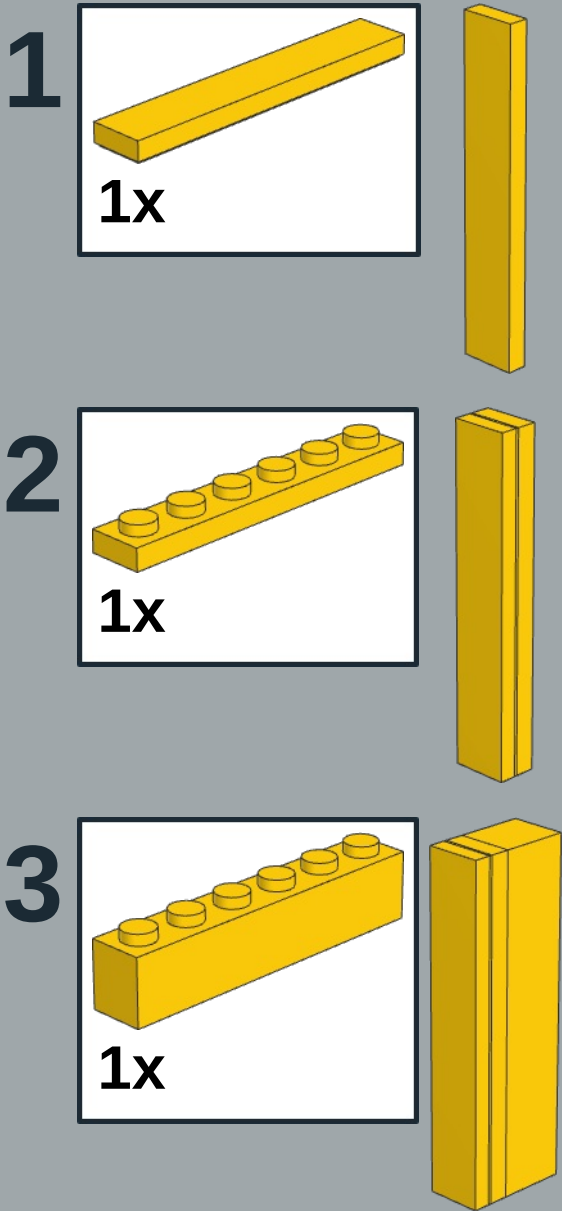

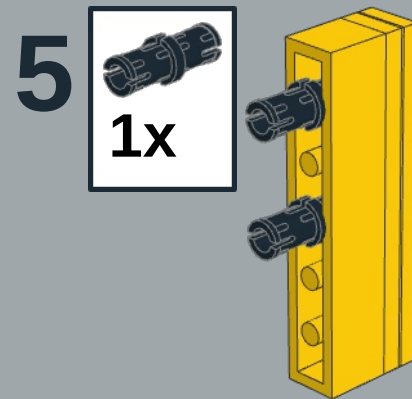
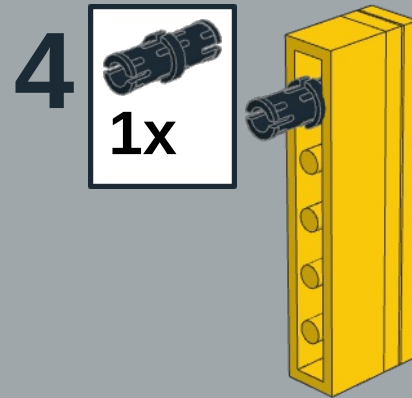

x2

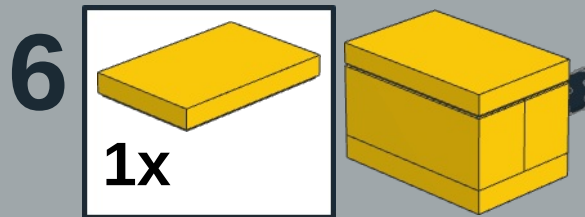
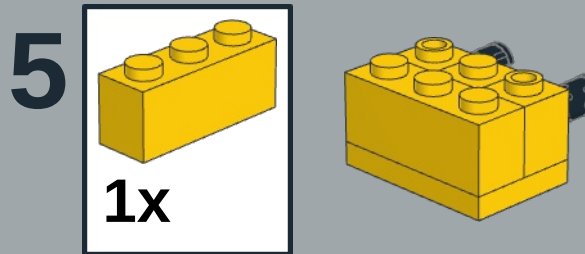
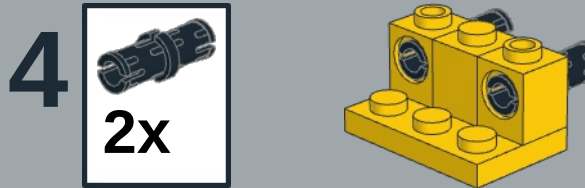
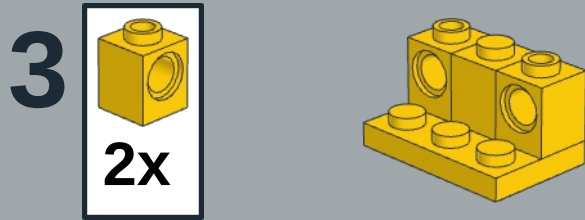
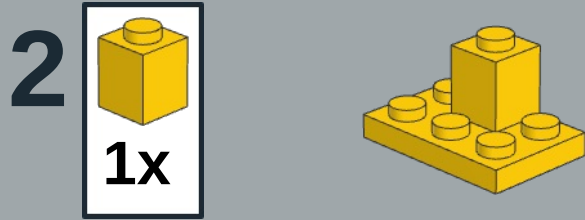
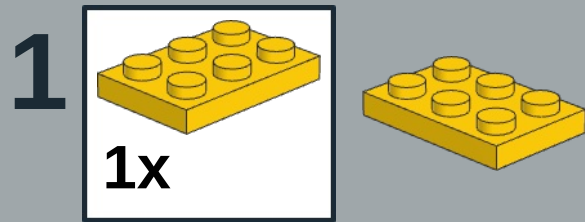

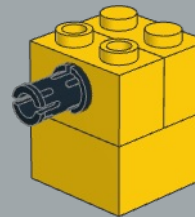
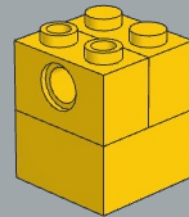
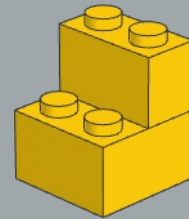
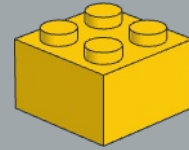
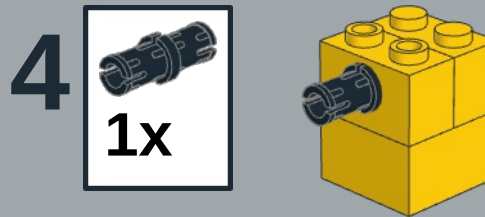
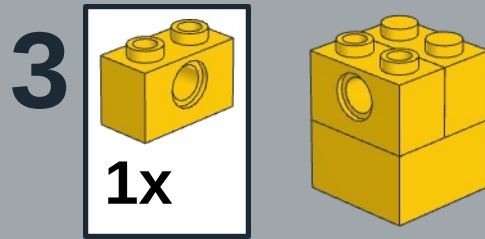
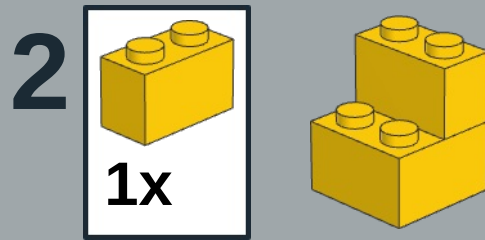
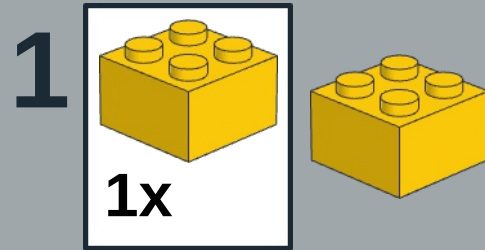

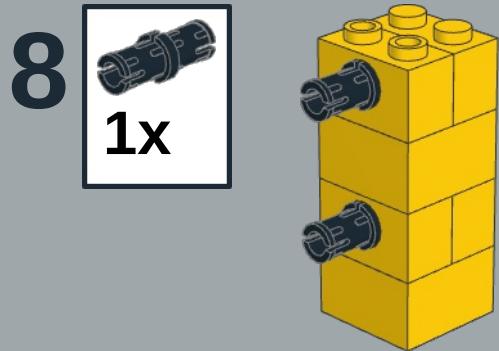
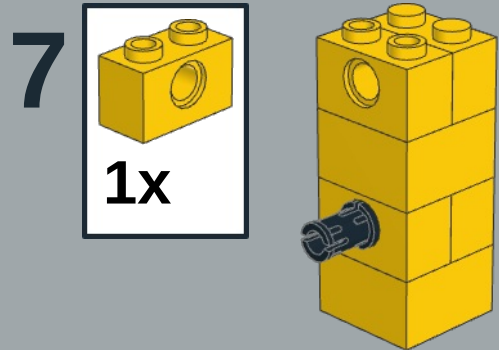
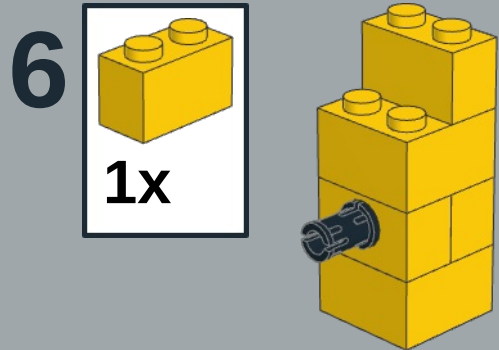
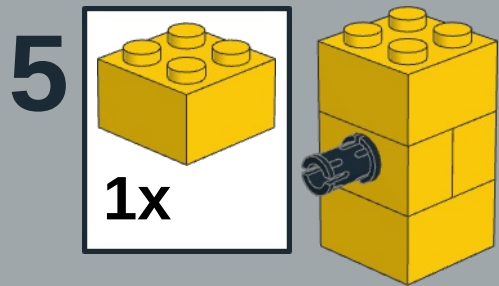

9

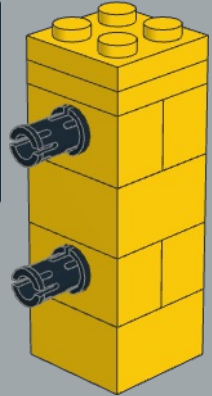
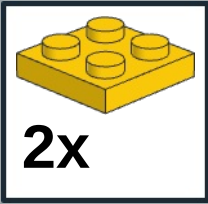

10

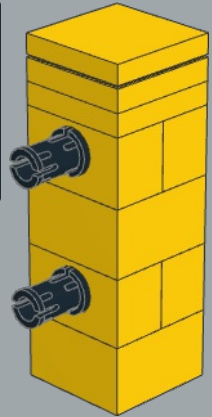
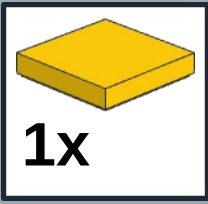

x2

1

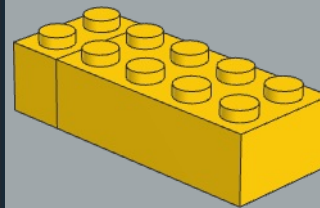
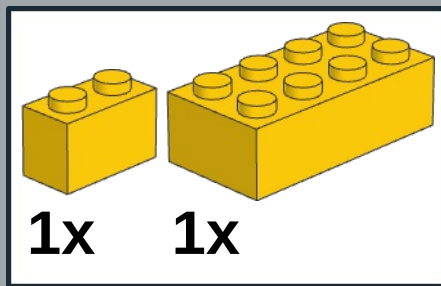

2

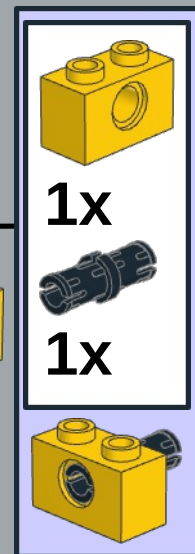
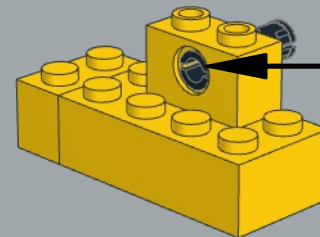

3

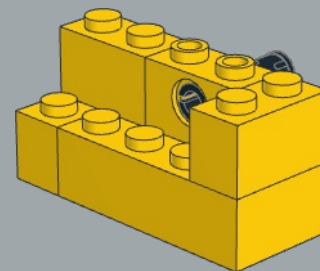

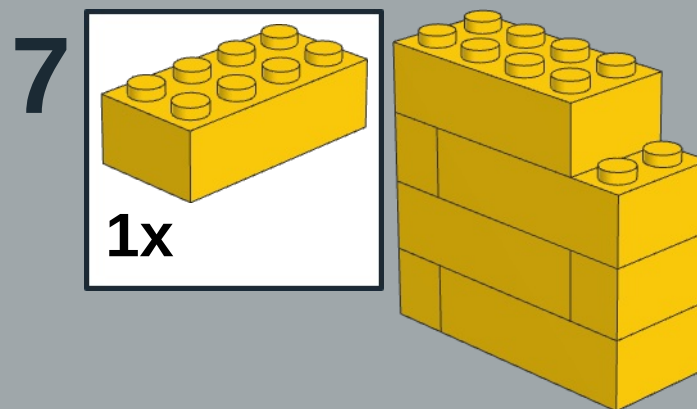
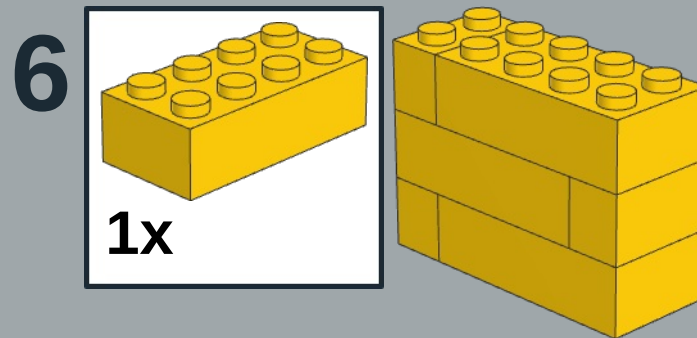
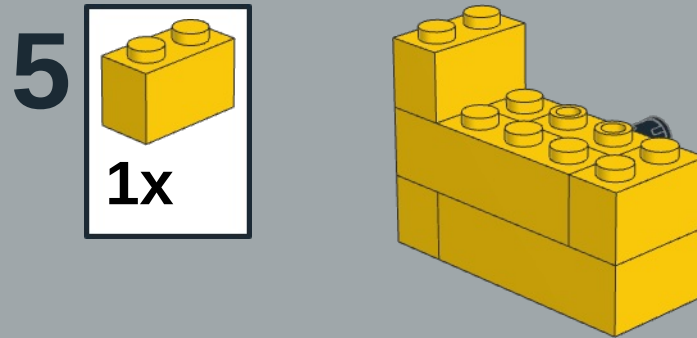
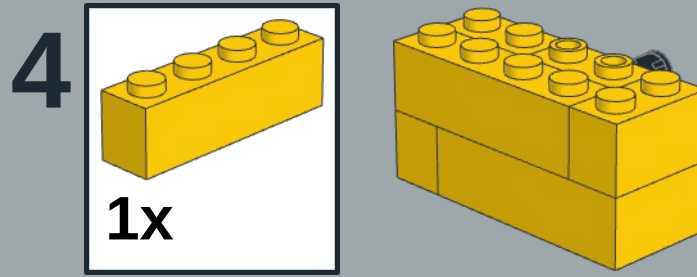

8

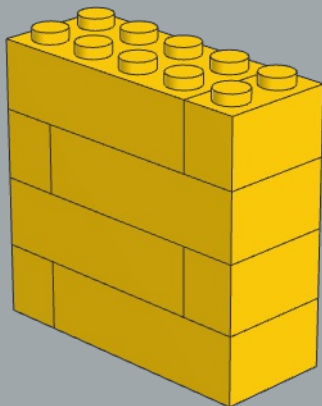
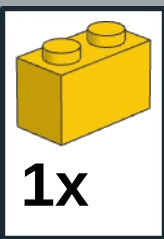

9

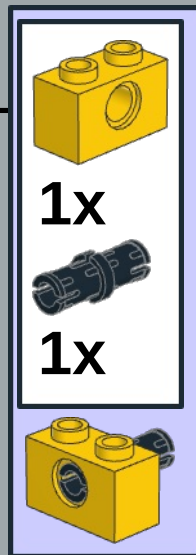
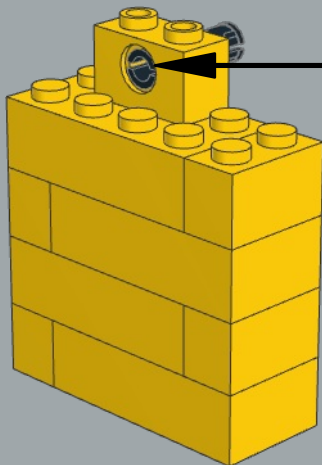

10

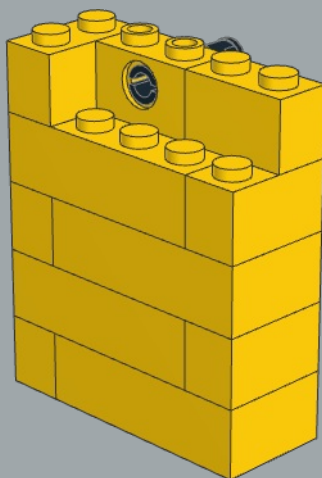

11

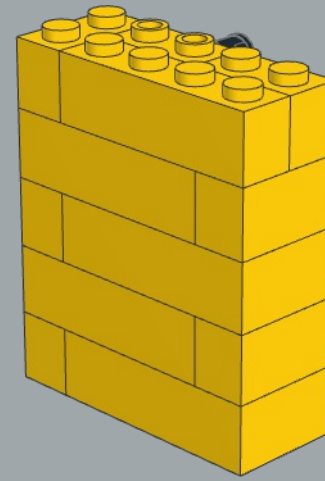
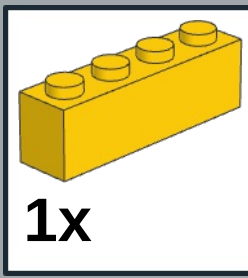

12

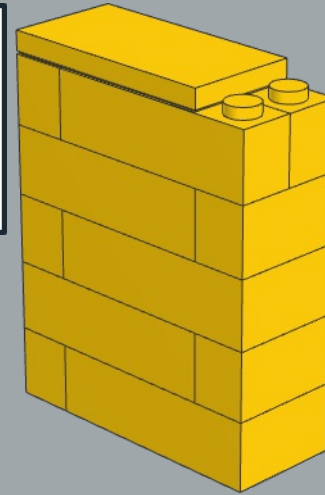
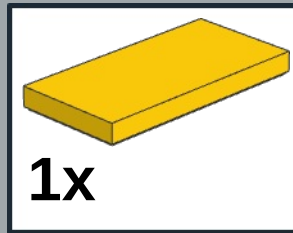

13

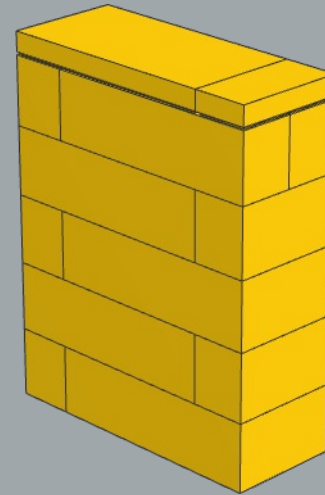
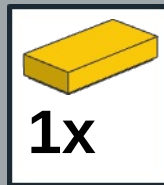

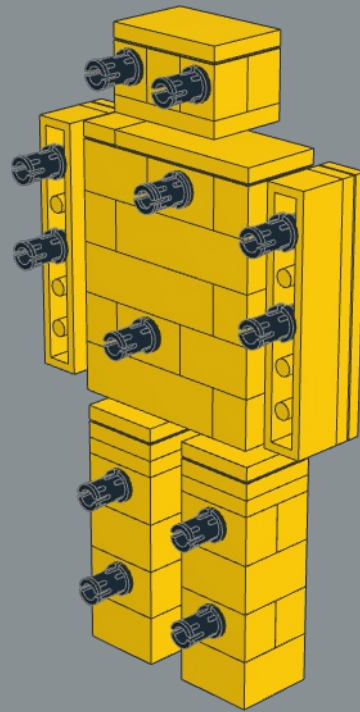

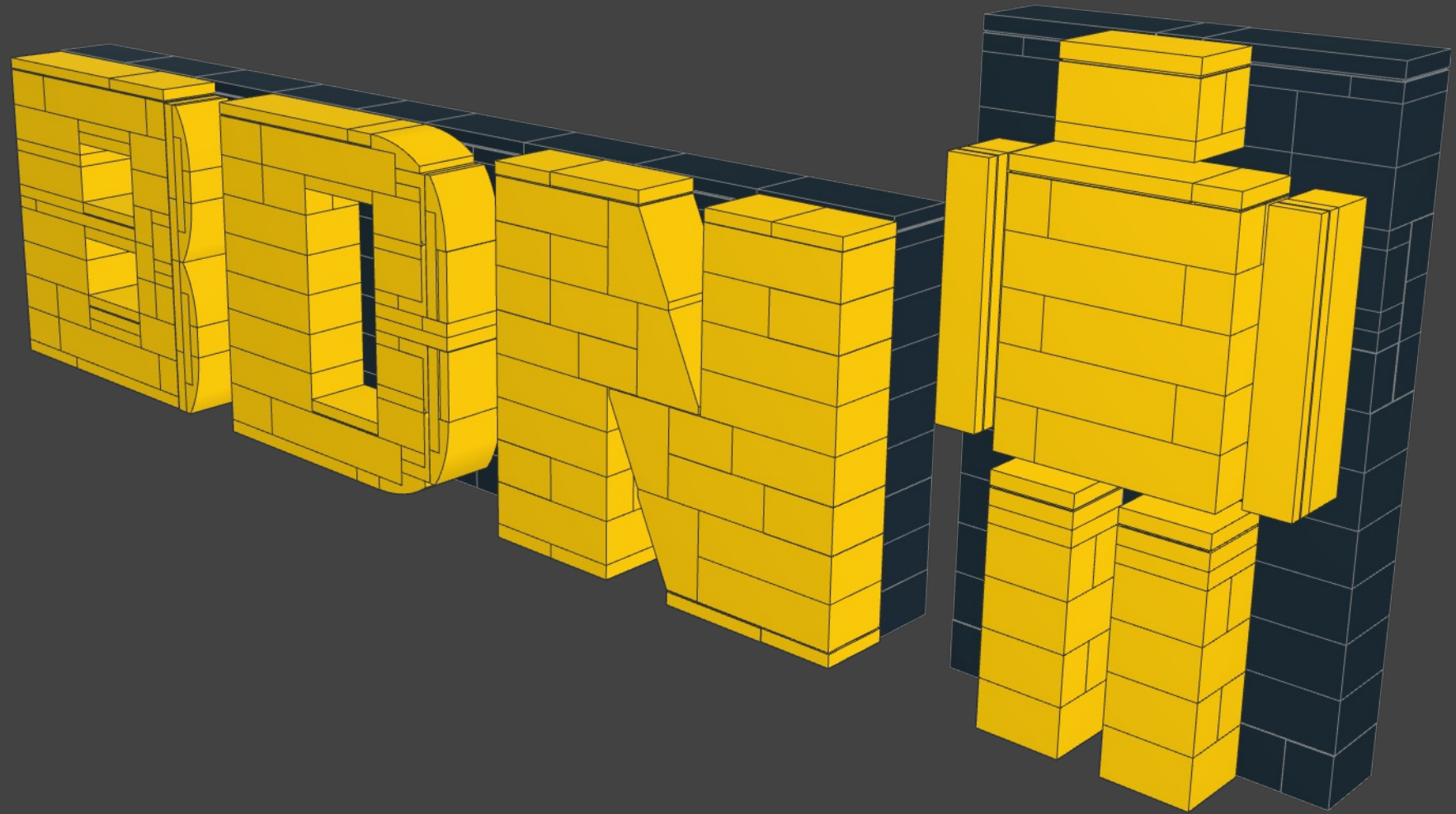

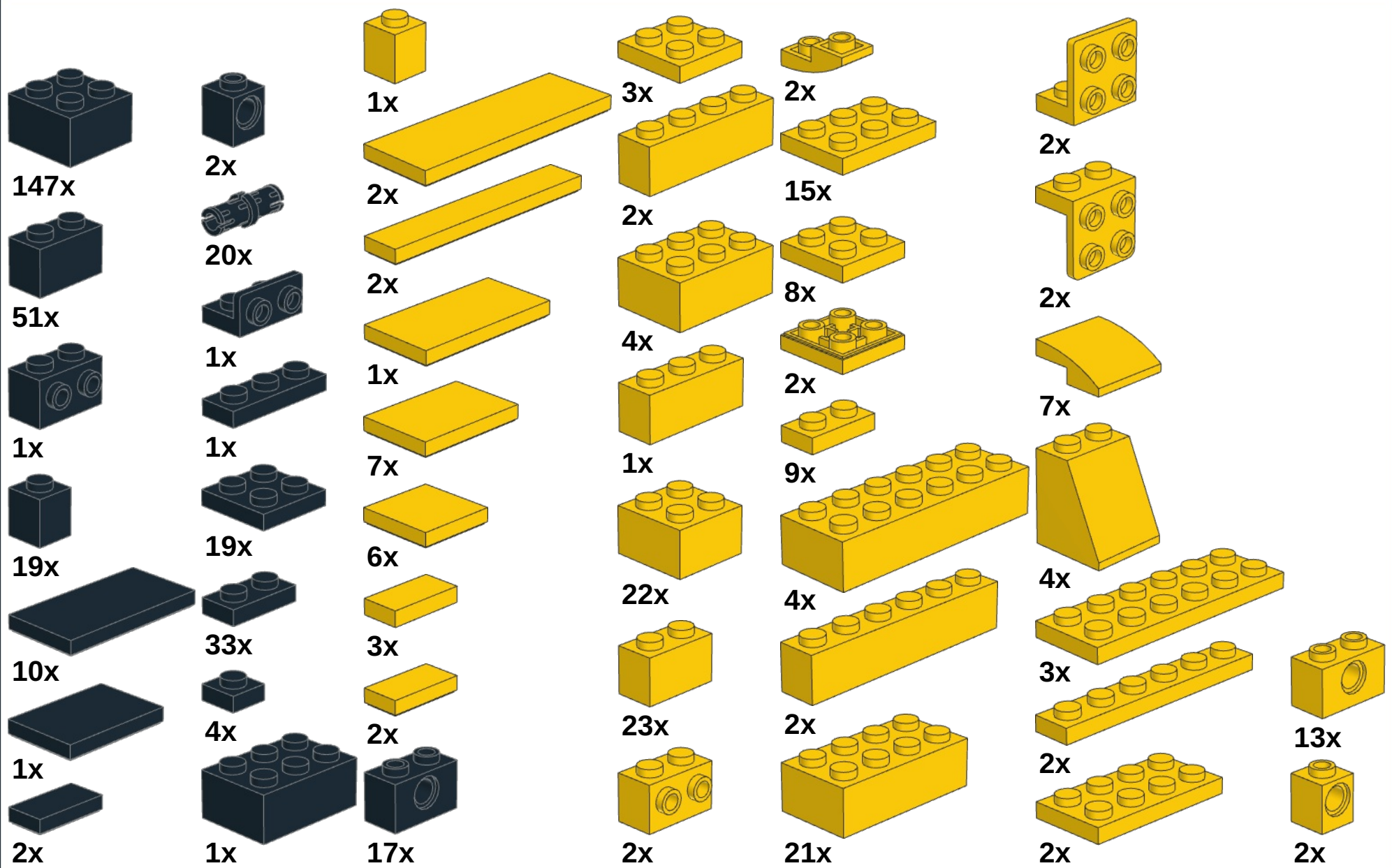

Hope you had fun with this model and instructions.
As always you can reach out to me via email:

birdbrickbuilds@gmail.com

You can also check my work on rebrickable and
instagram:

<https://rebrickable.com/users/birdbrickbuilds/>

<https://www.instagram.com/birdbrickbuilds/>

If you wish to help me continue to make this
models and instructions you can buy me a coffee
to help me stay up late:

<https://www.buymeacoffee.com/birdbrickbl>

Or you can buy my Coffee Espresso MOC:

<https://reb.li/m/118798>



This work is licensed under a [Creative Commons Attribution-NonCommercial-ShareAlike 4.0 International License](https://creativecommons.org/licenses/by-nc-sa/4.0/).

LEGO® is a registered trademark of the LEGO Group, which does not sponsor, endorse, or authorize these instructions or the model they depict.

*Instructions configured and generated using LPub3D 2.4.3.0.2557
Download LPub3D at <https://trevorsandy.github.io/lpub3d/>*

