

# **Braga Warriors**

## **João Bermudes**

Model instructions by Bird Brick Builds  
Author: Eduardo Sousa  
146 Parts



# Attribution-NonCommercial-ShareAlike 4.0 International (CC BY-NC-SA 4.0)

This is a human-readable summary of (and not a substitute for) the [license](#). [Disclaimer](#).

## You are free to:

**Share** — copy and redistribute the material in any medium or format

**Adapt** — remix, transform, and build upon the material

The licensor cannot revoke these freedoms as long as you follow the license terms.

---

## Under the following terms:



**Attribution** — You must give [appropriate credit](#), provide a link to the license, and [indicate if changes were made](#). You may do so in any reasonable manner, but not in any way that suggests the licensor endorses you or your use.



**NonCommercial** — You may not use the material for [commercial purposes](#).



**ShareAlike** — If you remix, transform, or build upon the material, you must distribute your contributions under the [same license](#) as the original.

**No additional restrictions** — You may not apply legal terms or [technological measures](#) that legally restrict others from doing anything the license permits.

---

## Notices:

You do not have to comply with the license for elements of the material in the public domain or where your use is permitted by an applicable [exception or limitation](#).

No warranties are given. The license may not give you all of the permissions necessary for your intended use. For example, other rights such as [publicity, privacy, or moral rights](#) may limit how you use the material.

1

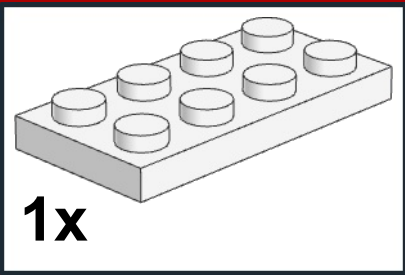

1x

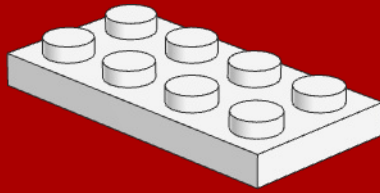

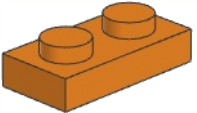
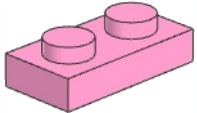
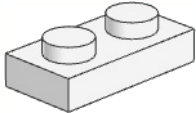
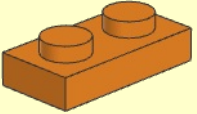
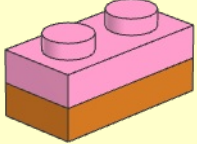
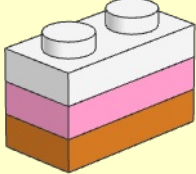
<p><b>1</b></p>  <p><b>1x</b></p>	<p><b>2</b></p>  <p><b>1x</b></p>	<p><b>3</b></p>  <p><b>1x</b></p>
		 <p><b>x2</b></p>

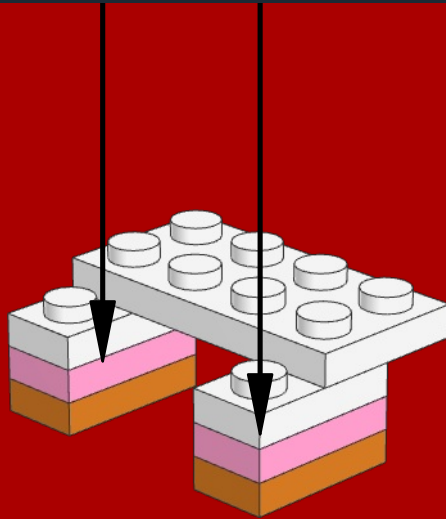

**3**

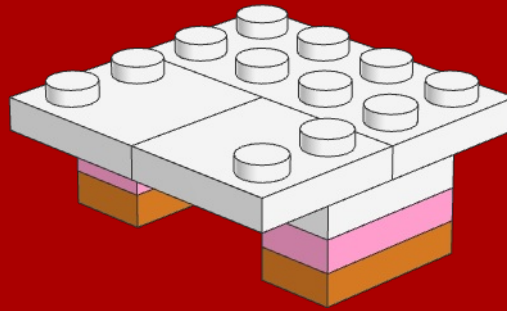
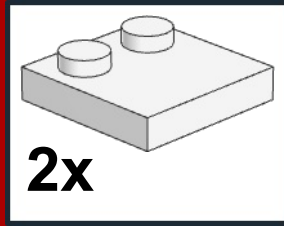

**4**

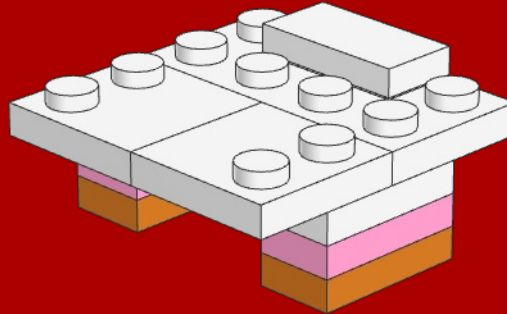
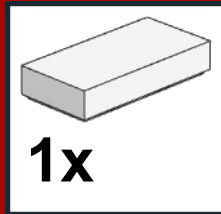

**5**

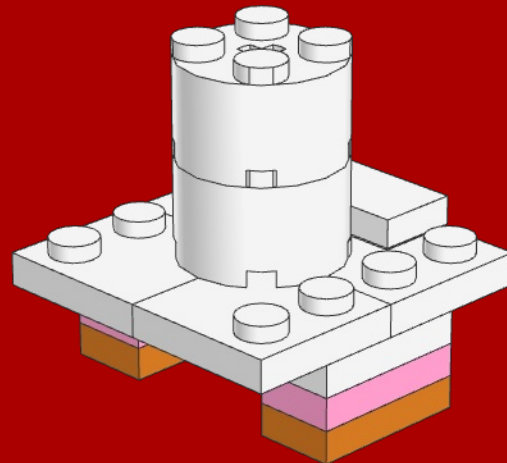
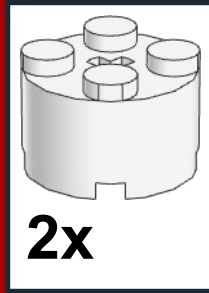

6

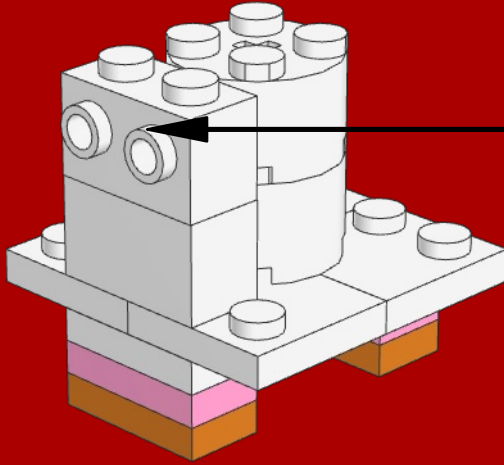
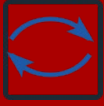

1

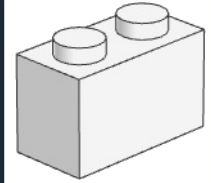

1x

2

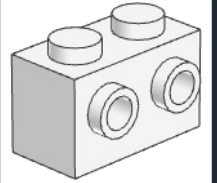

1x

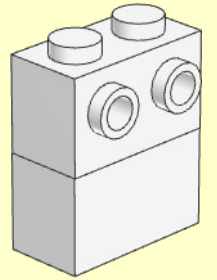
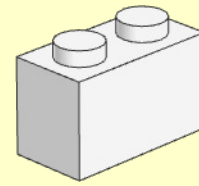

7

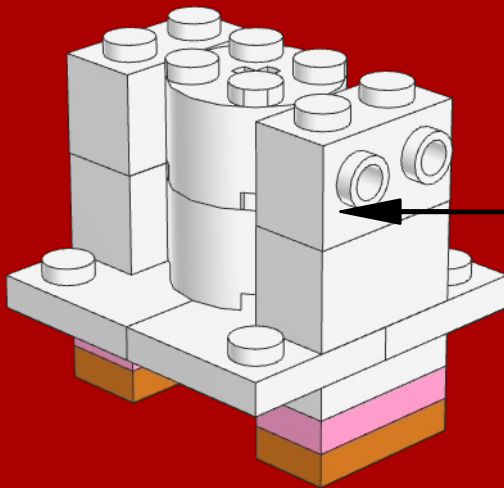

1

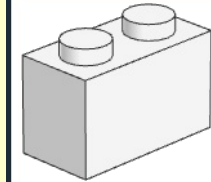

1x

2

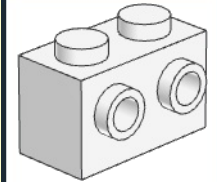

1x

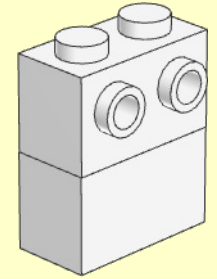
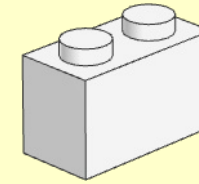

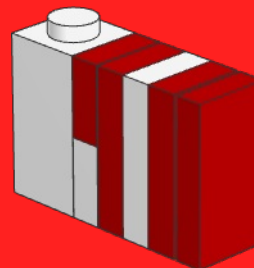
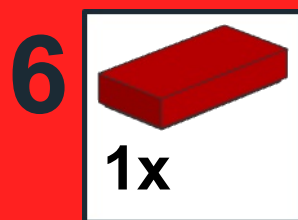
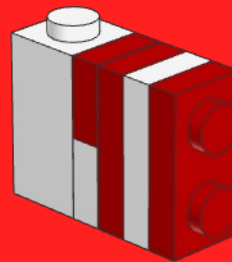
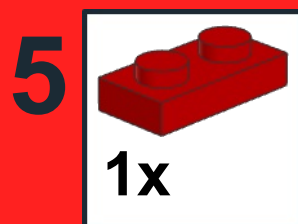
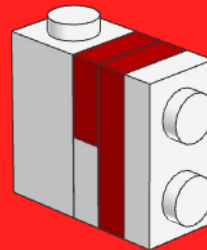
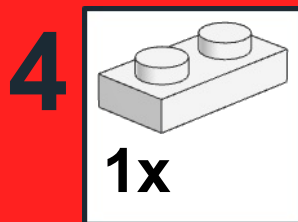
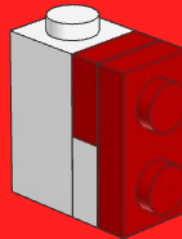
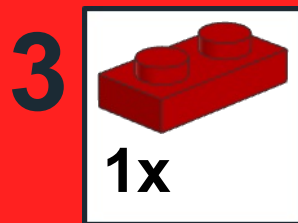
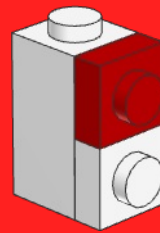
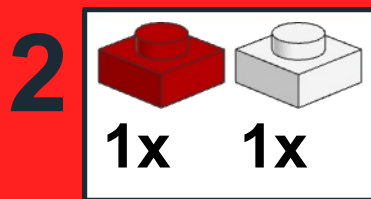
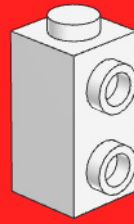
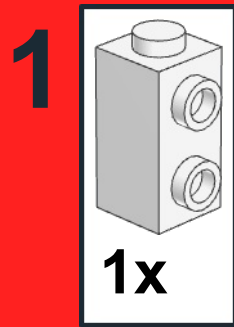

7

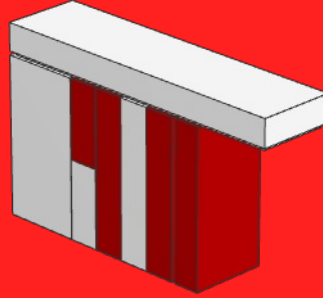
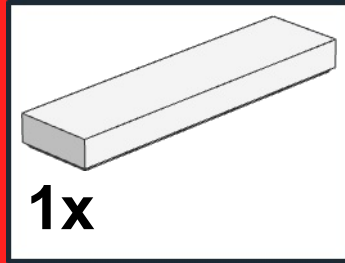

8

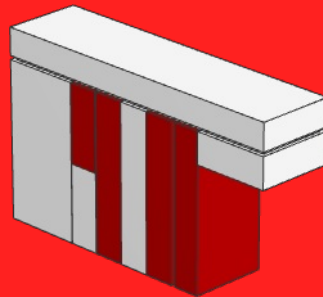
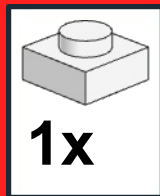

9

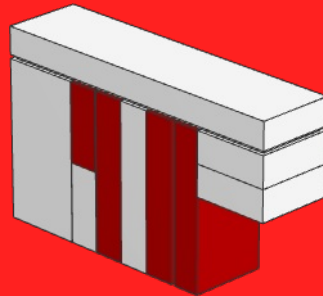
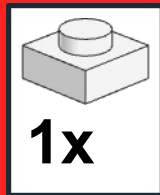

10

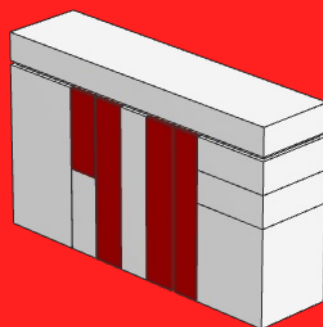
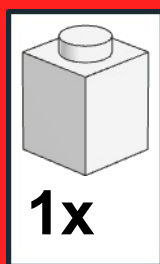



8

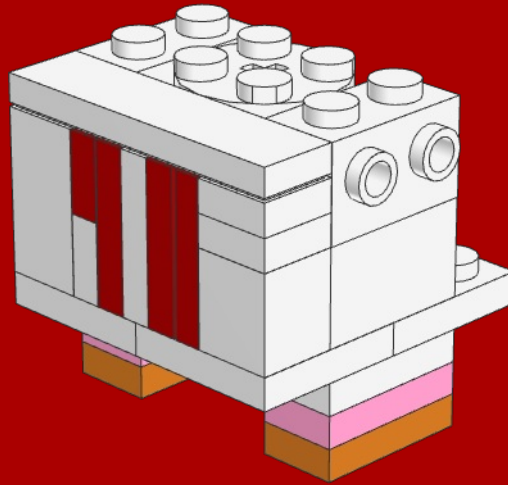

9

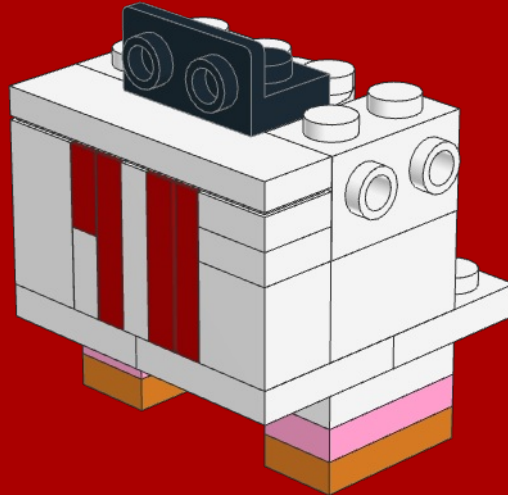
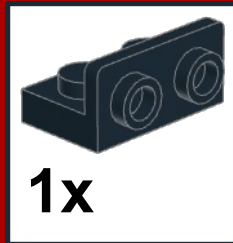

10

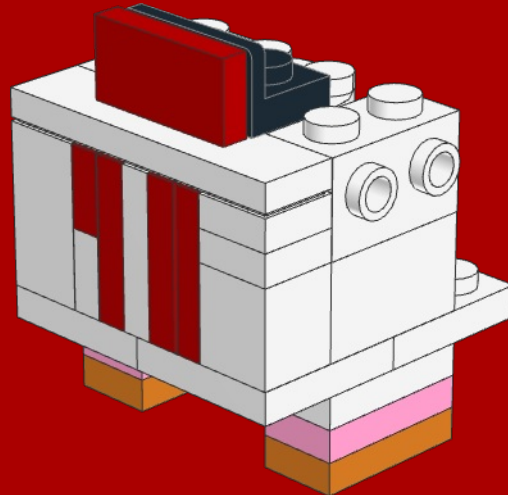
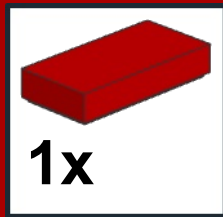

11

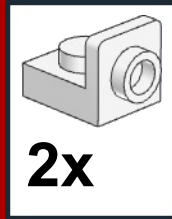

2x

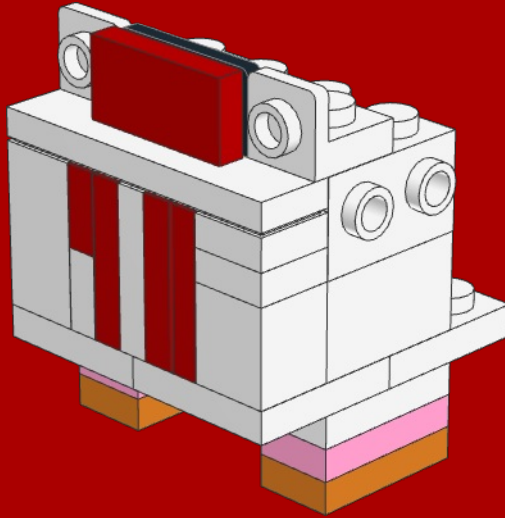

12

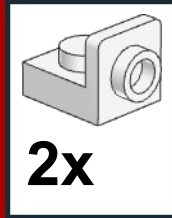

2x

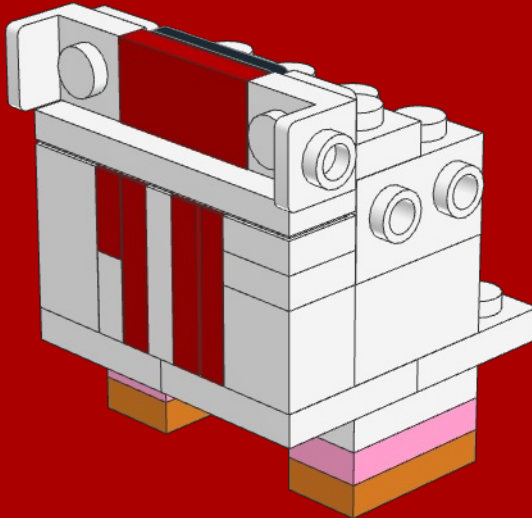

13

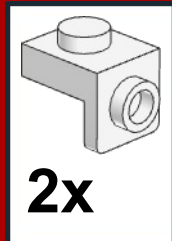

2x

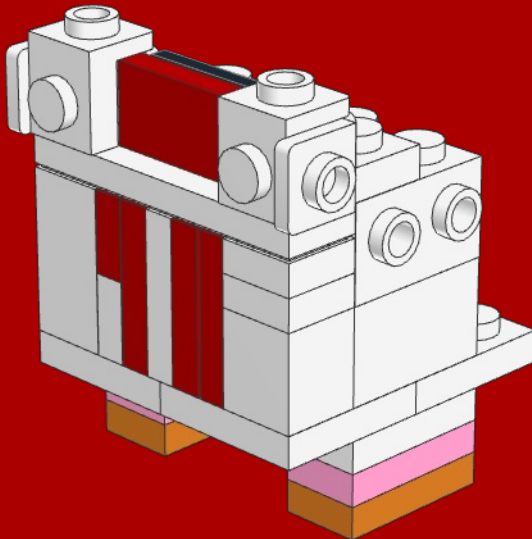

14

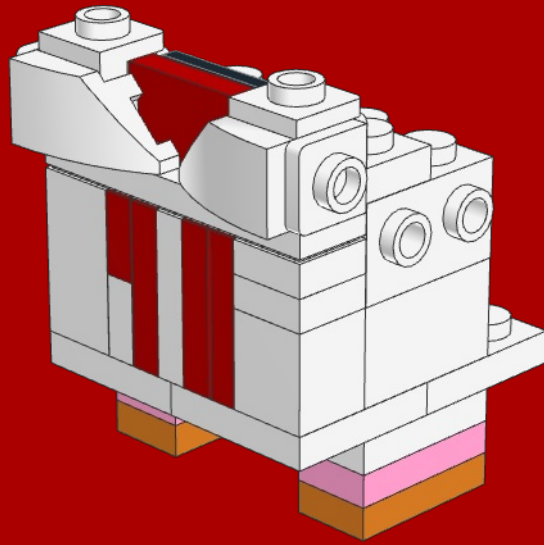
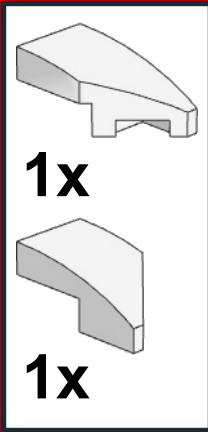

15

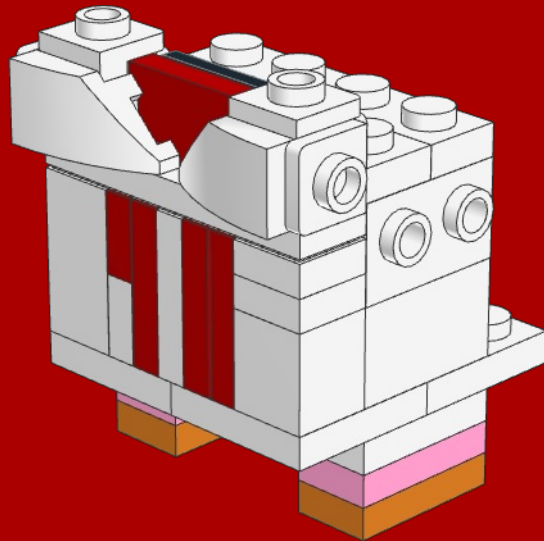
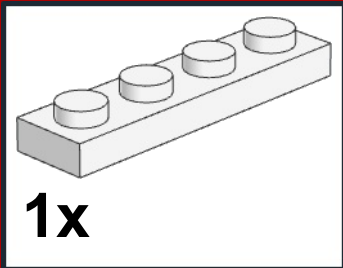

16

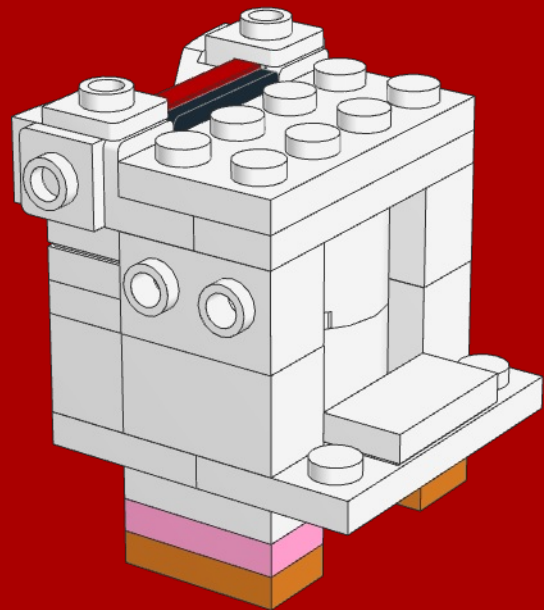
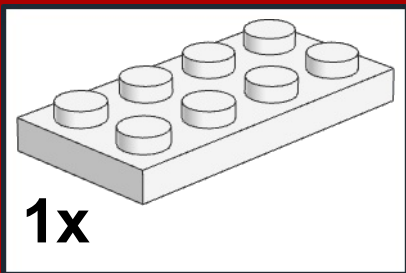

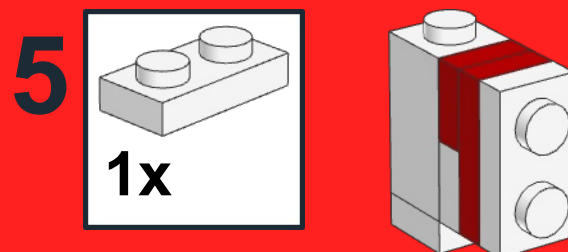
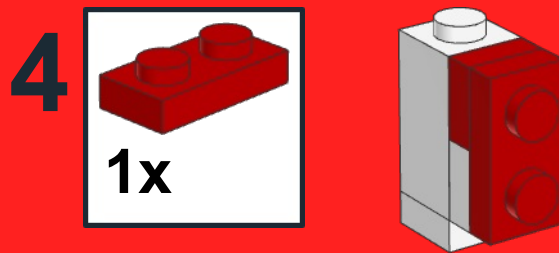
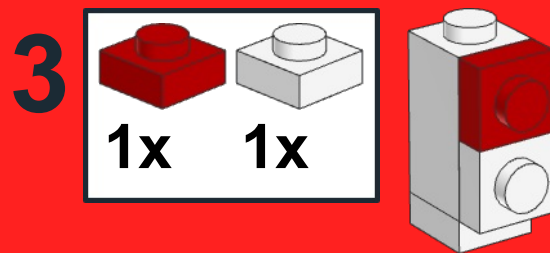
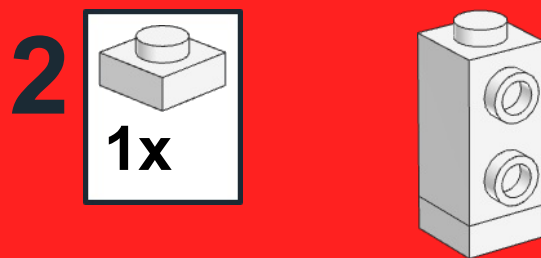
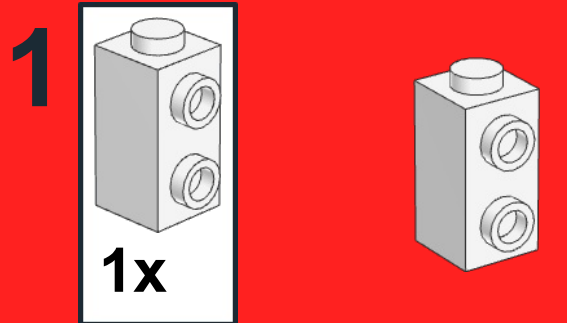

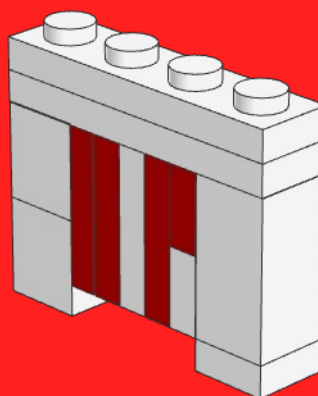
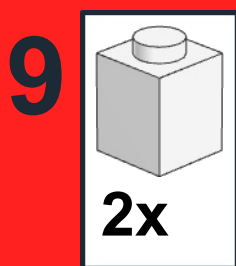
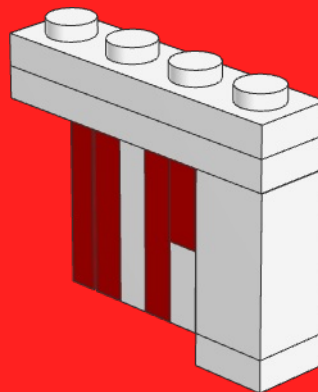
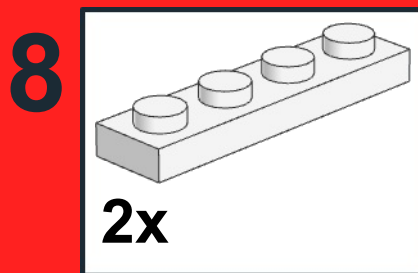
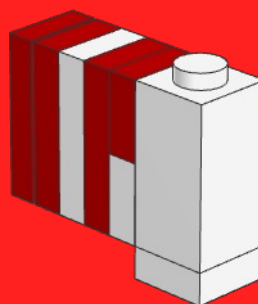
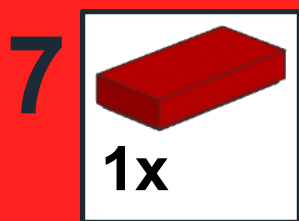
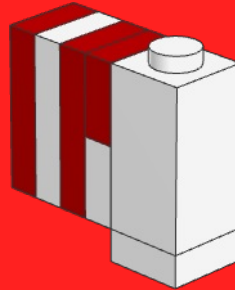
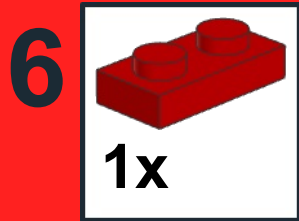

17

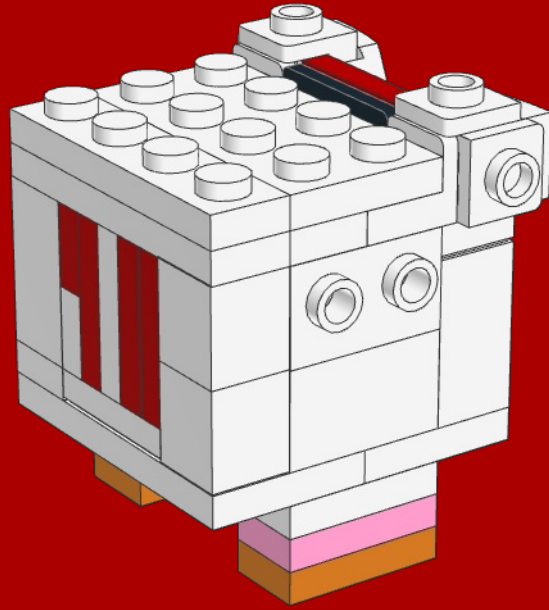

18

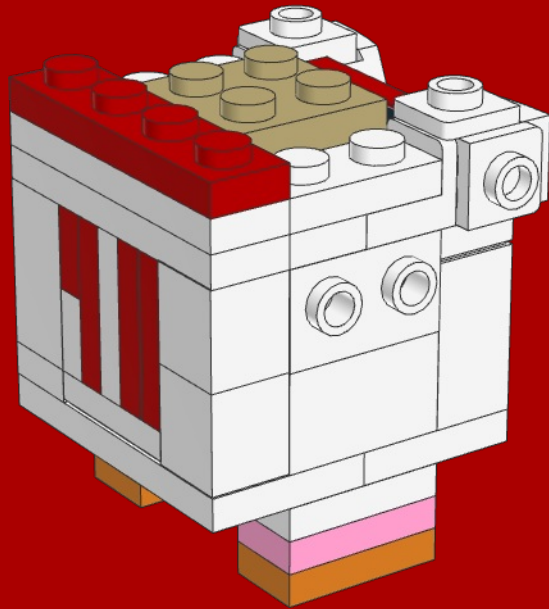
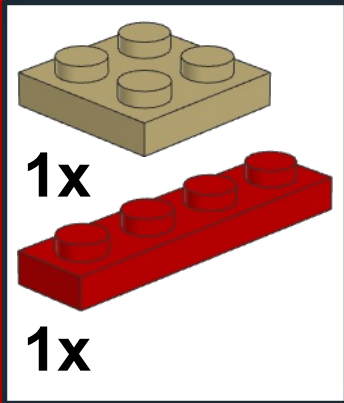

19

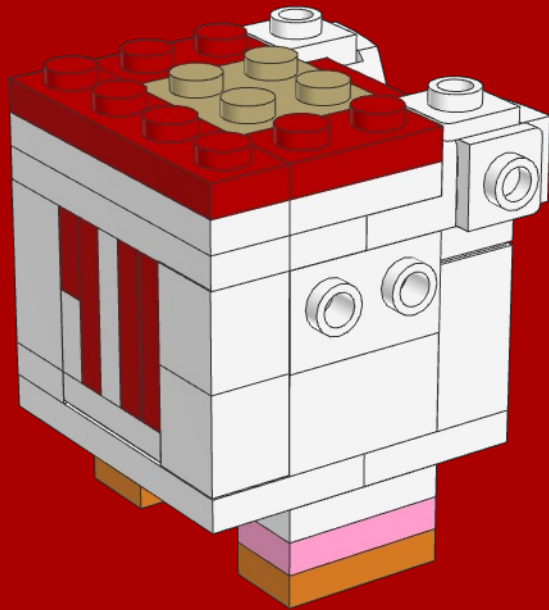
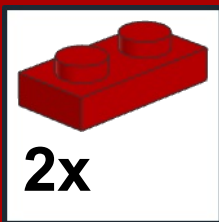

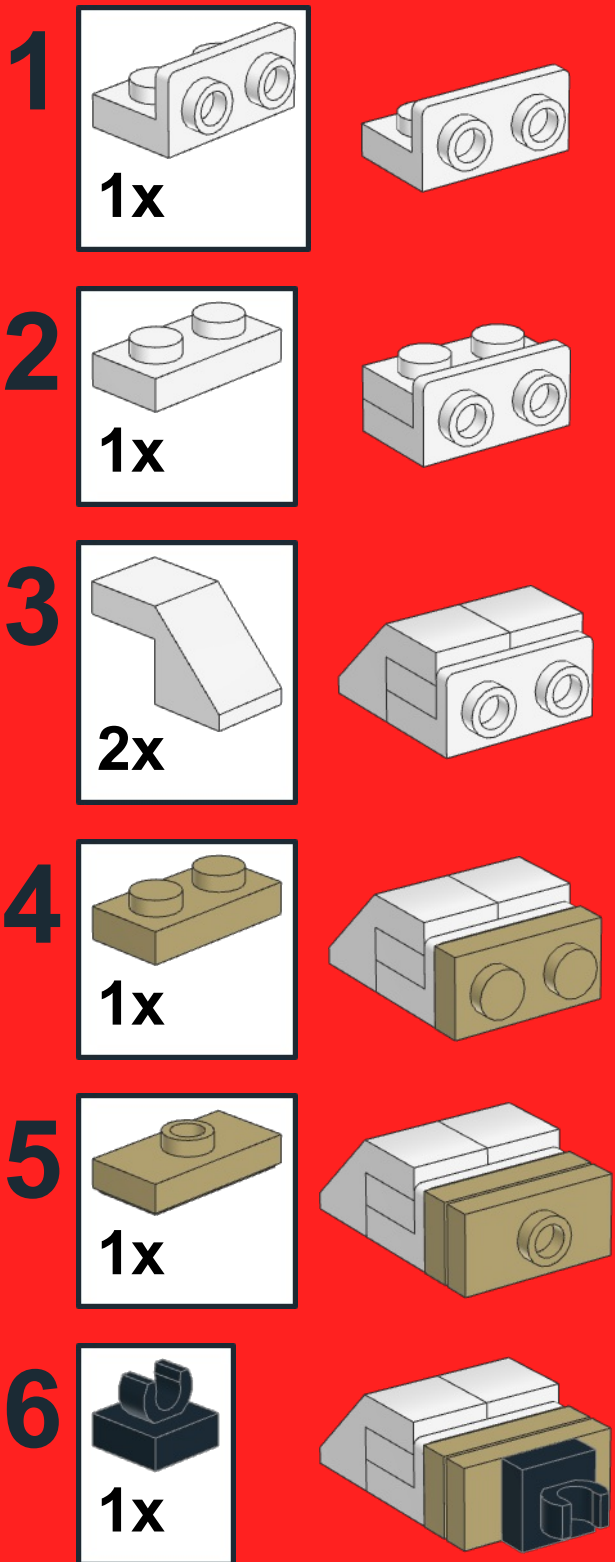

x2

20

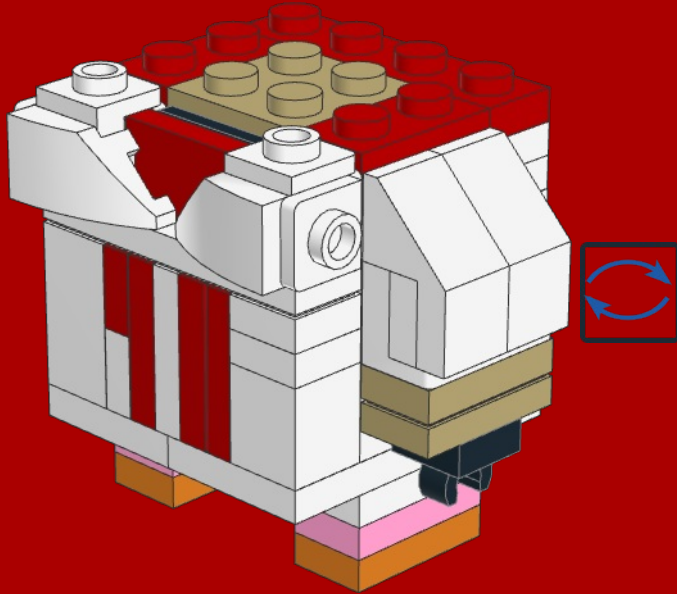

21

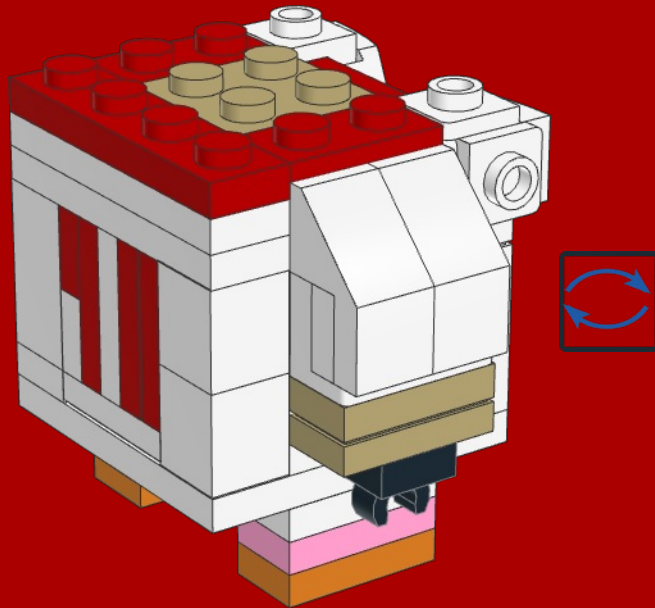



**22**

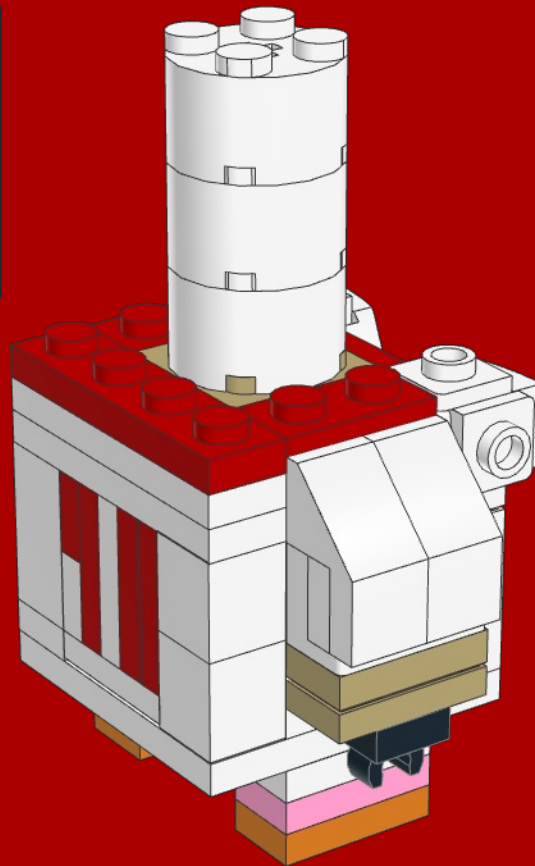
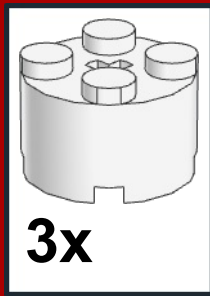

**23**

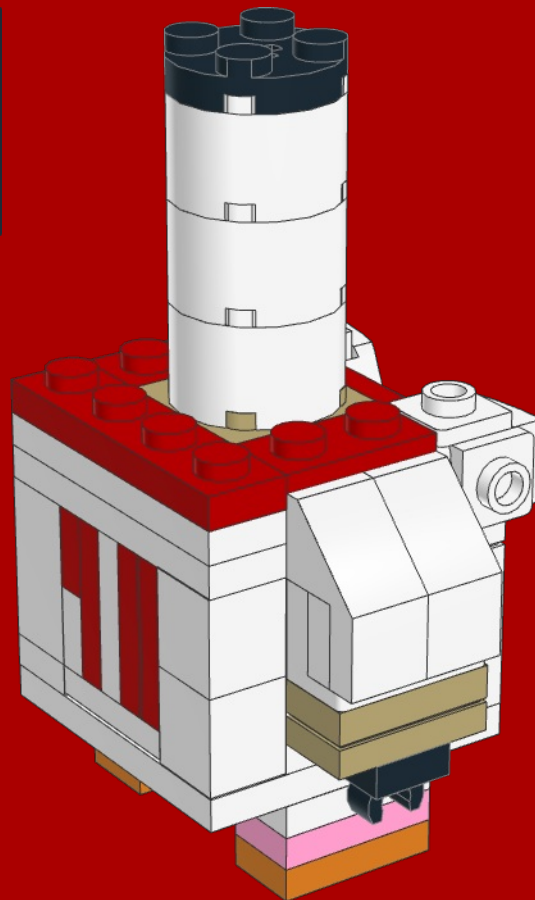
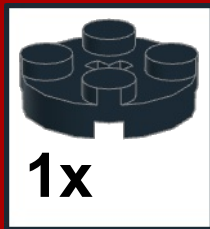

24

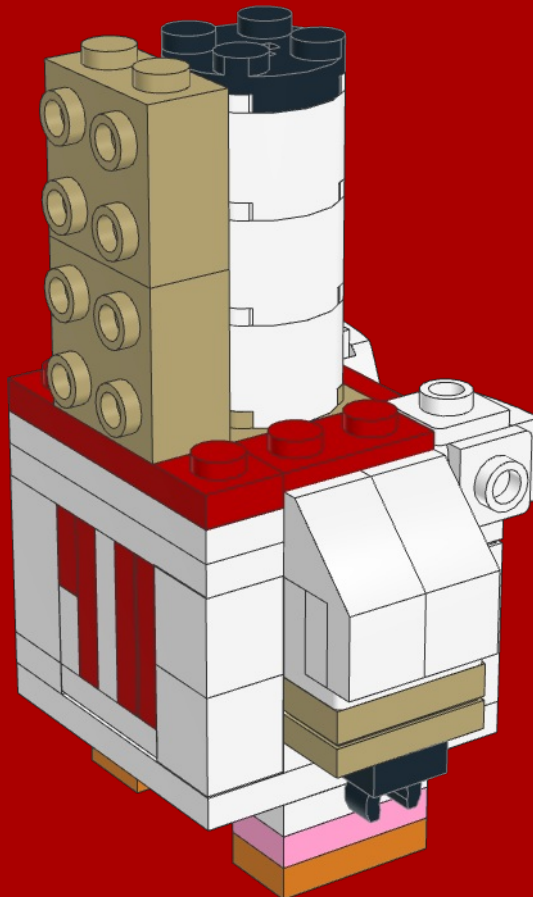
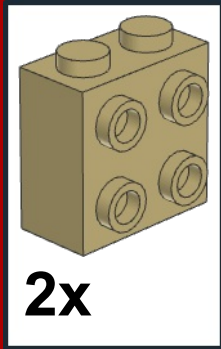

25

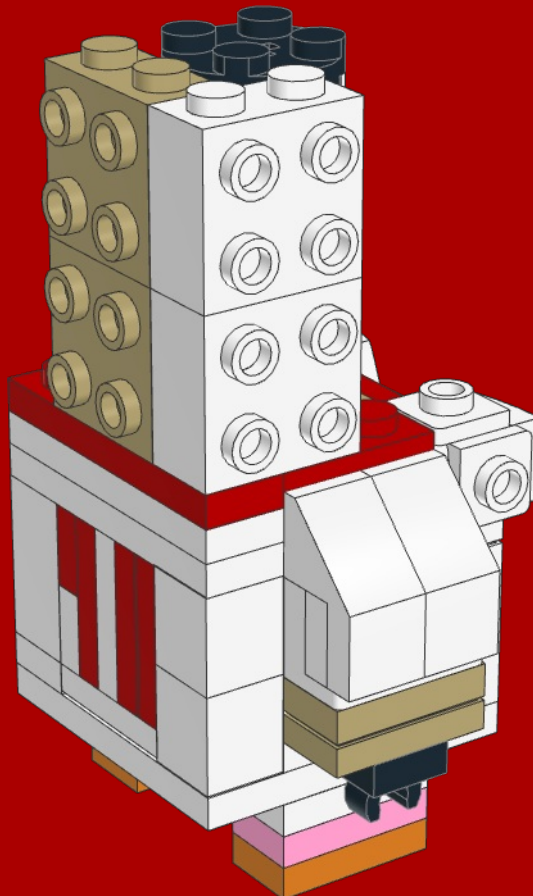
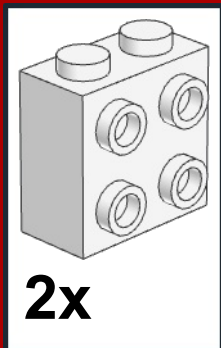

26

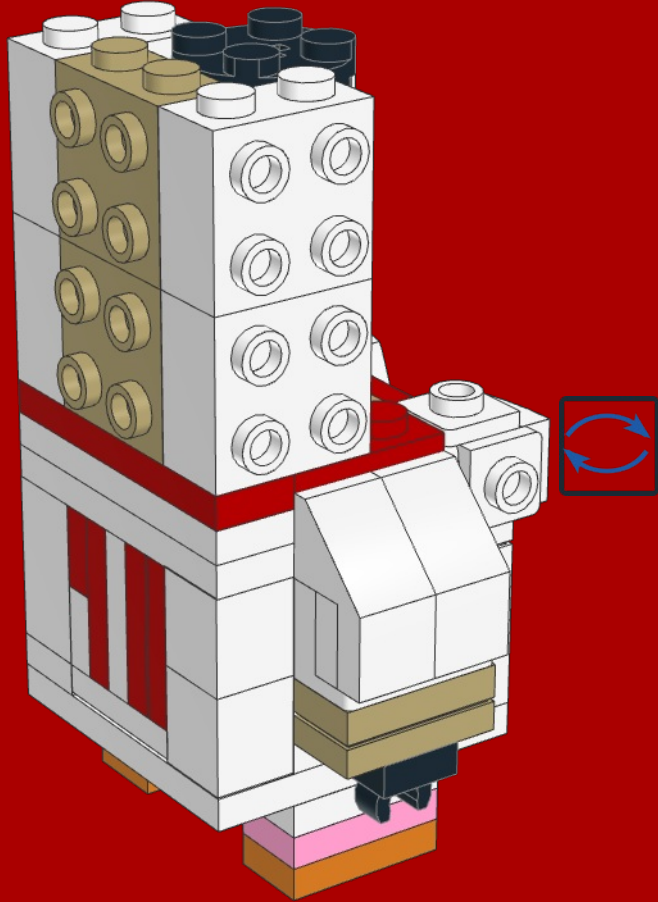
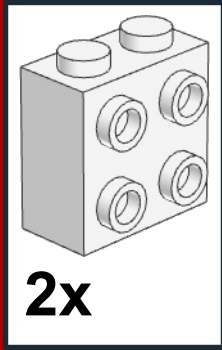

27

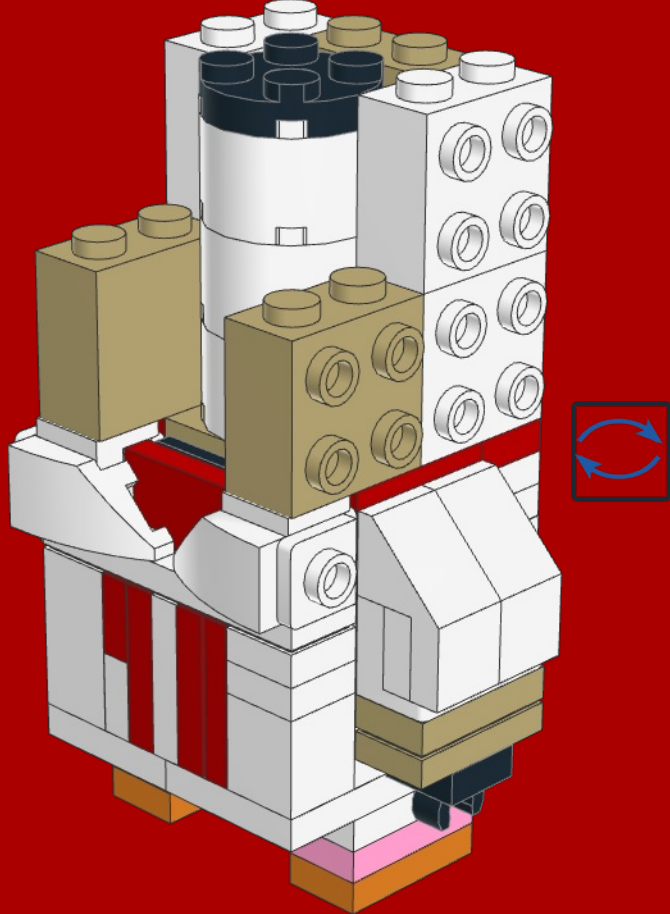
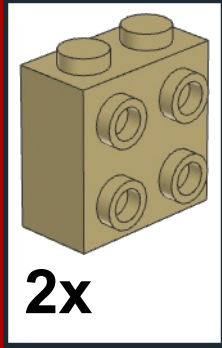

28

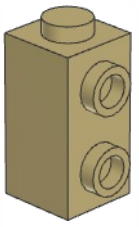

2x

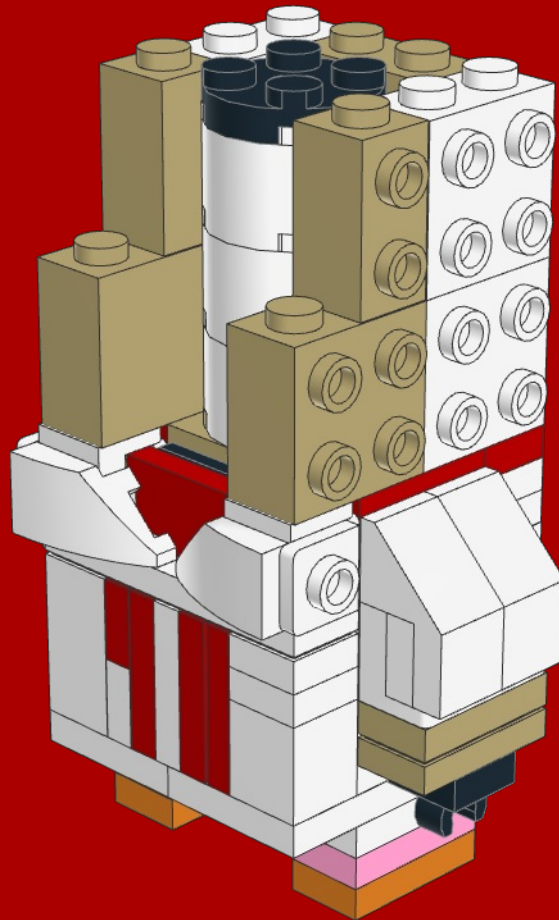

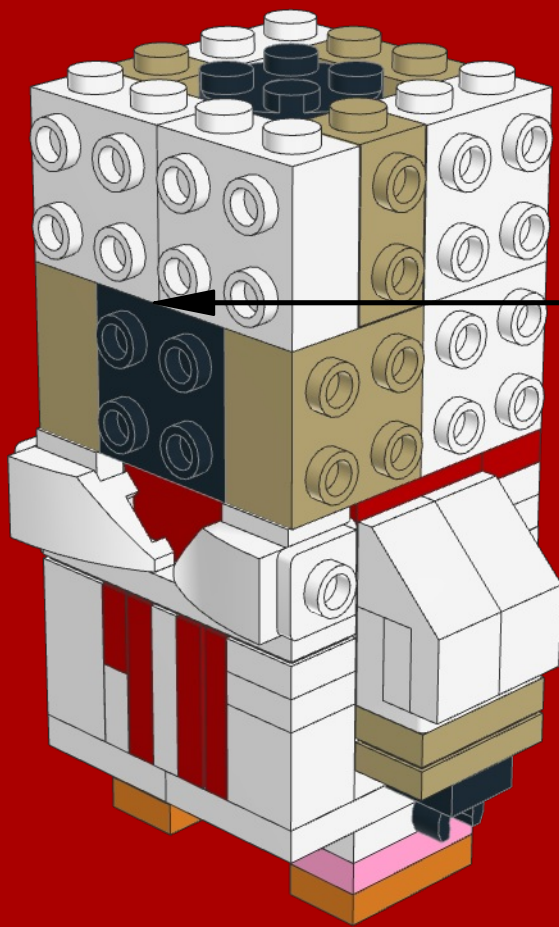

1

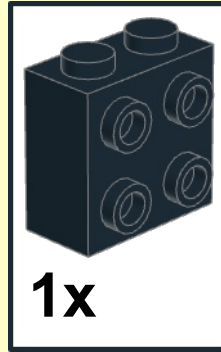

1x

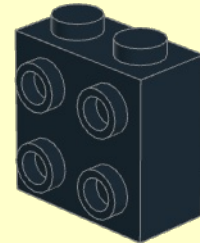

2

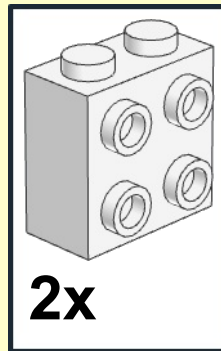

2x

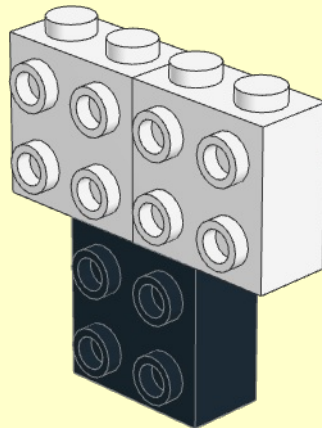

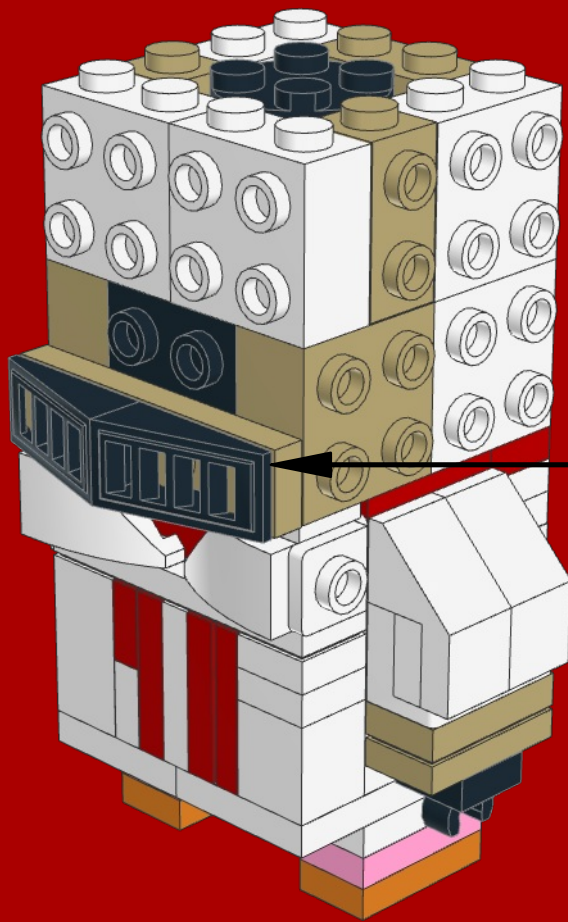

1

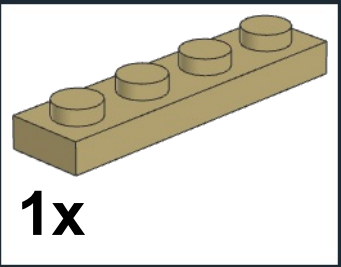

1x

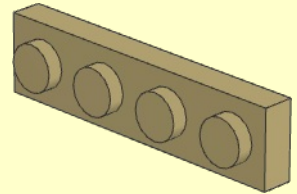

2



2x

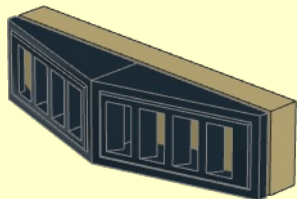

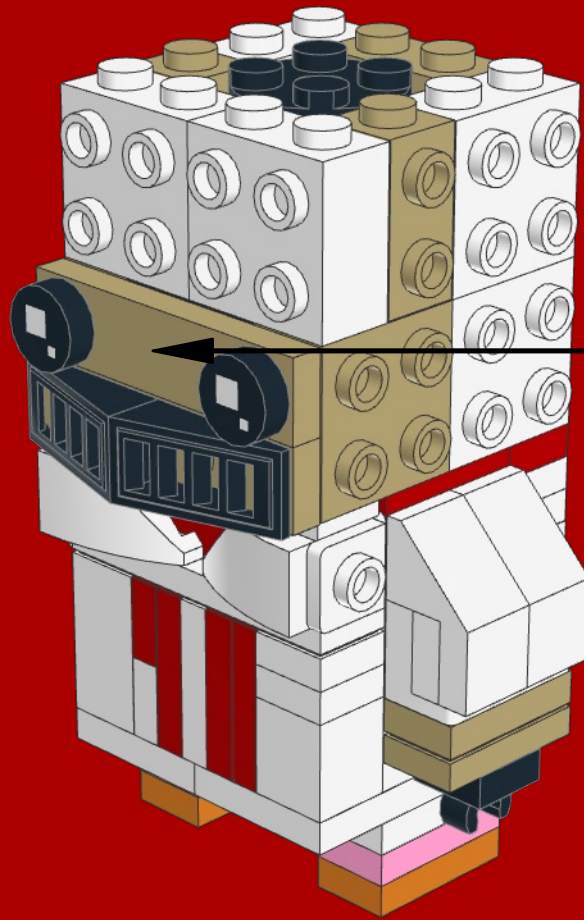

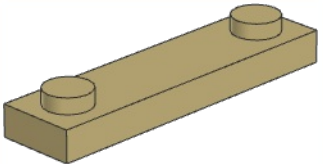

1

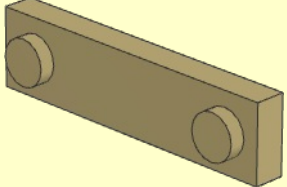

1x



2



2x

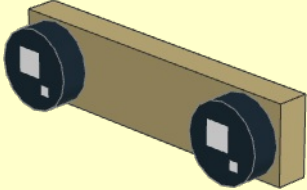

This block contains the parts list for step 1. It is set against a light yellow background. At the top, the number '1' is displayed. Below it is a tan Technic beam with two holes, the rightmost hole having a small circular bump. The quantity '1x' is written below the beam. Below this is another tan Technic beam with two holes. At the bottom, the number '2' is displayed. Below it is a black Technic bush. The quantity '2x' is written below the bush. At the very bottom is a tan Technic beam with two holes, each with a black Technic bush inserted into one of the holes.

32

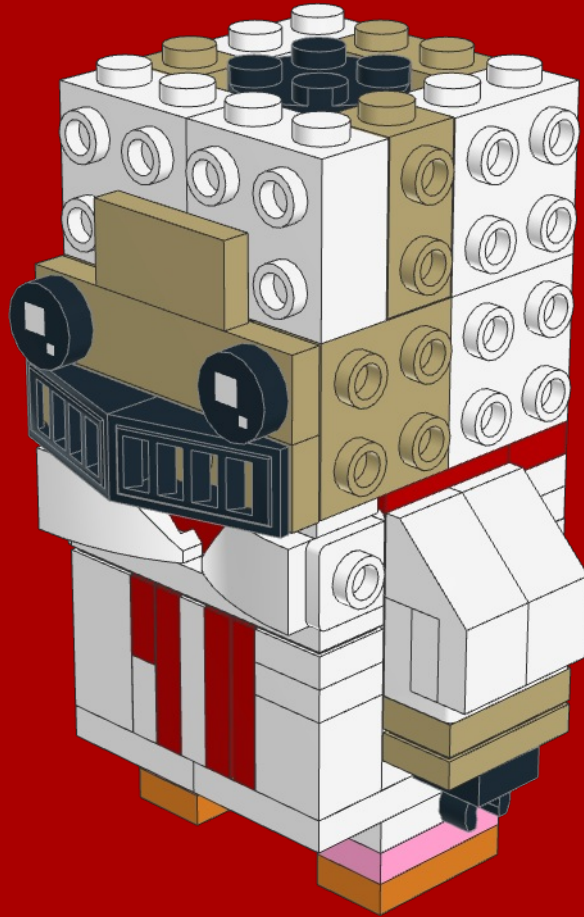
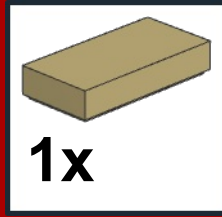

33

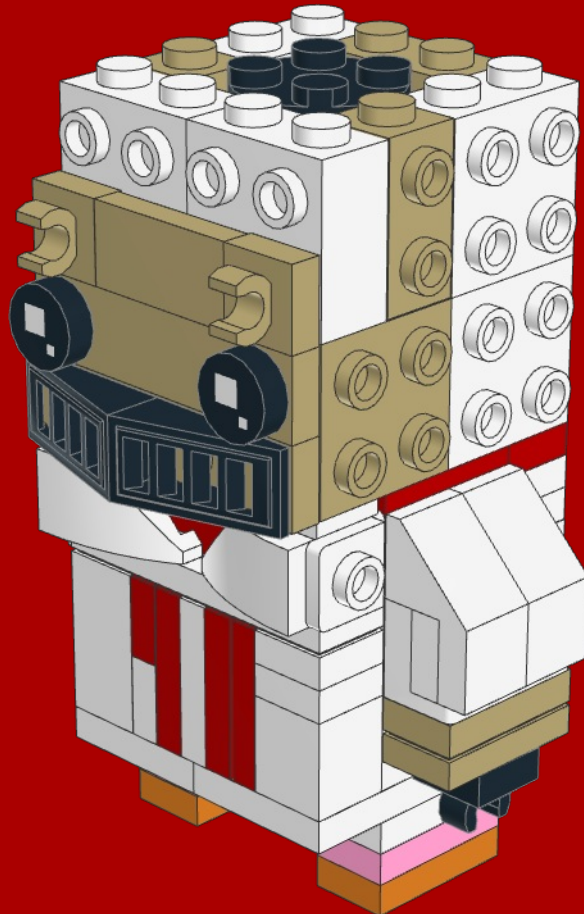
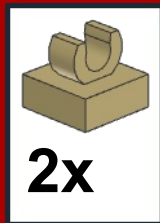



34

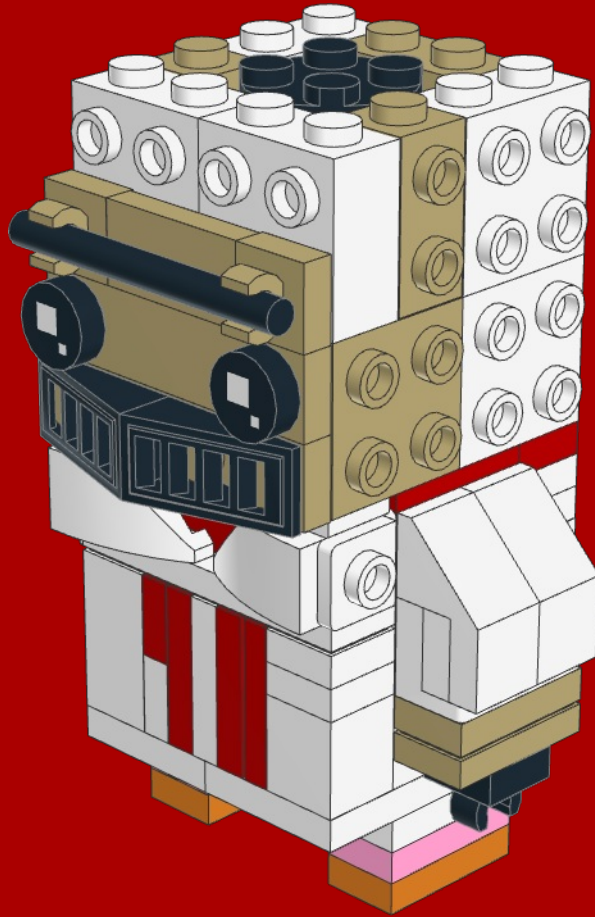

35

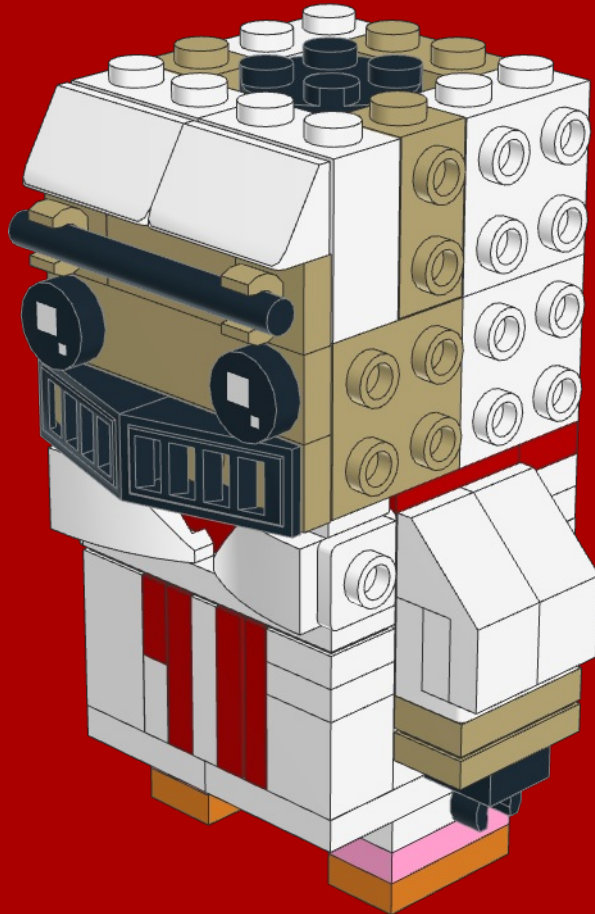
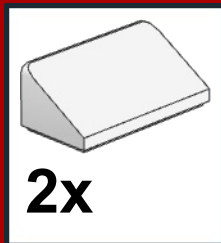

36

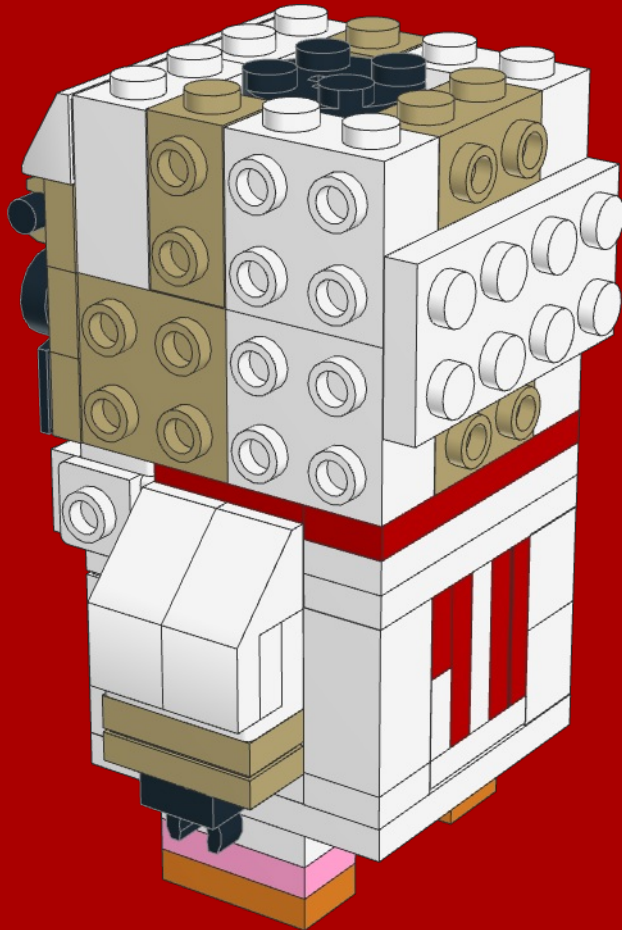
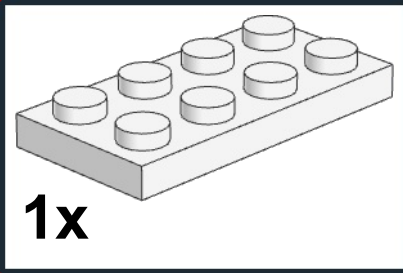

37

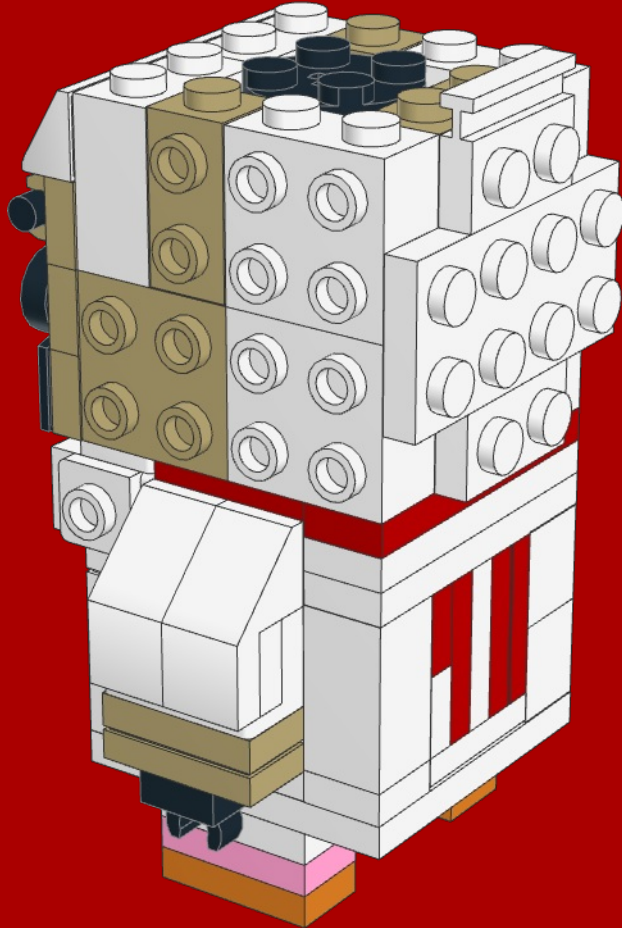
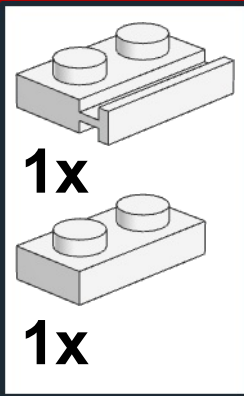

38

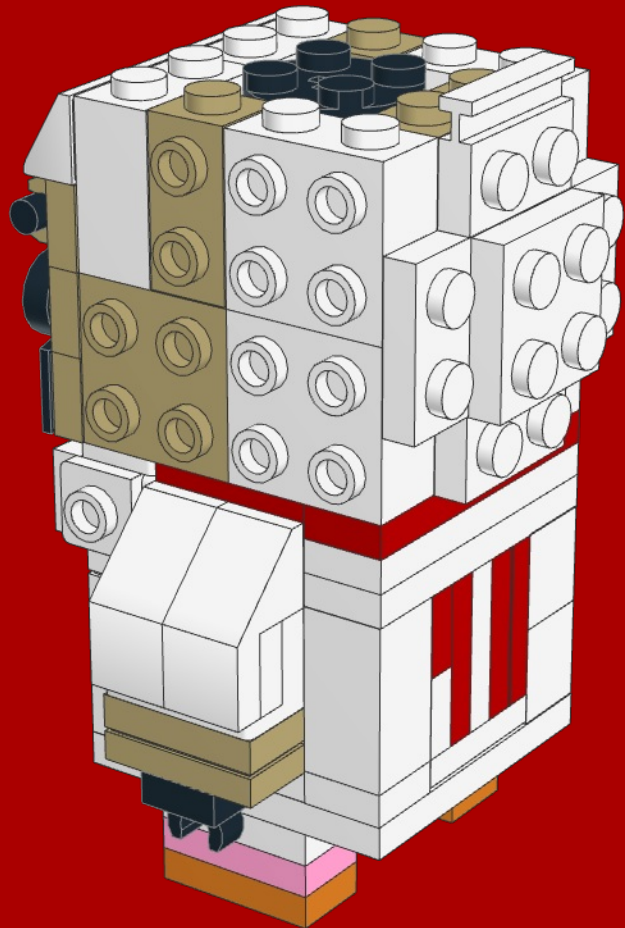
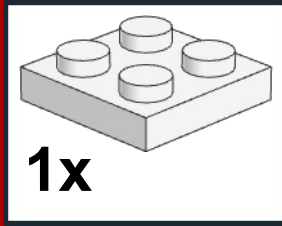

39

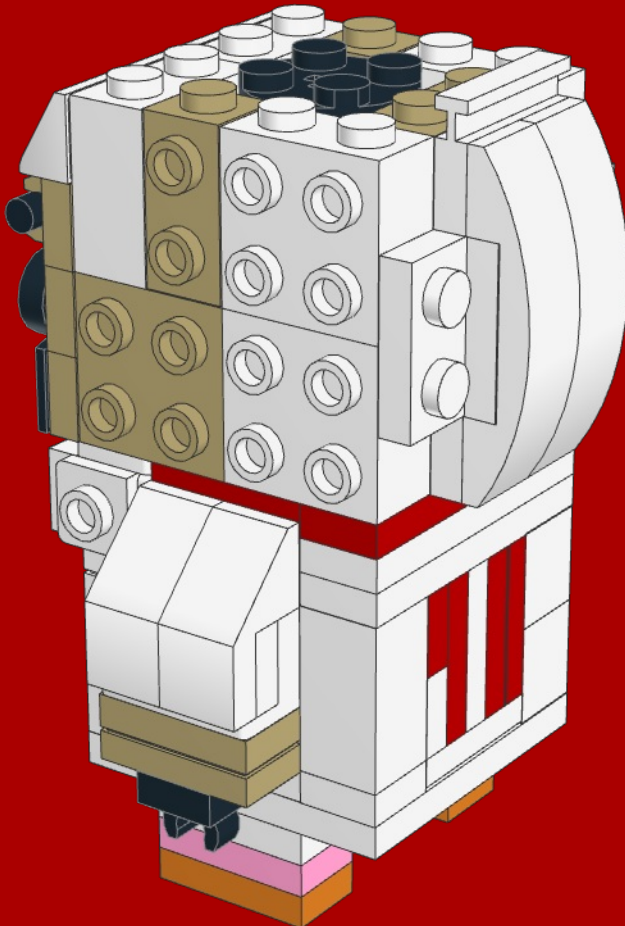

40

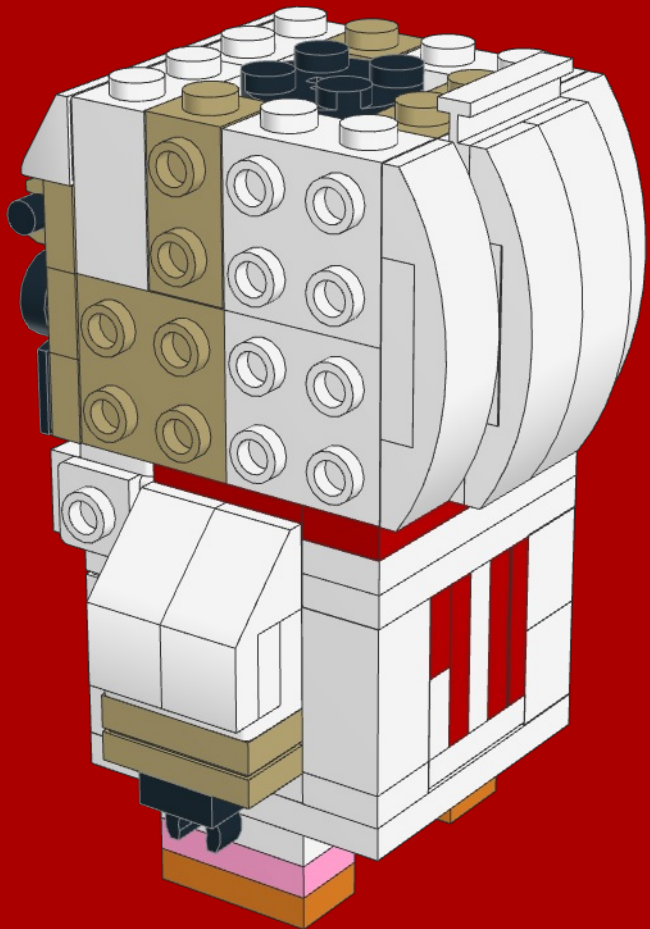
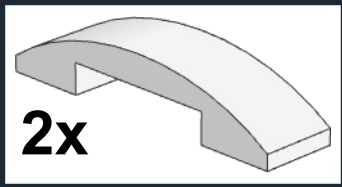

41

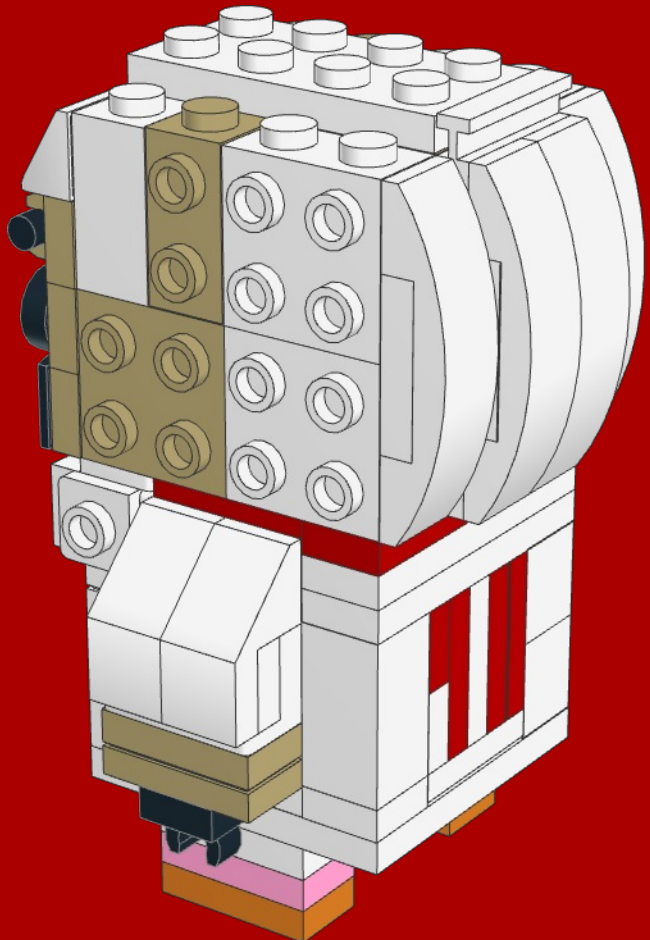
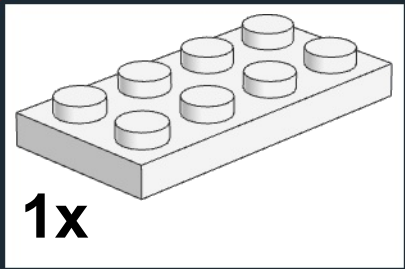

42

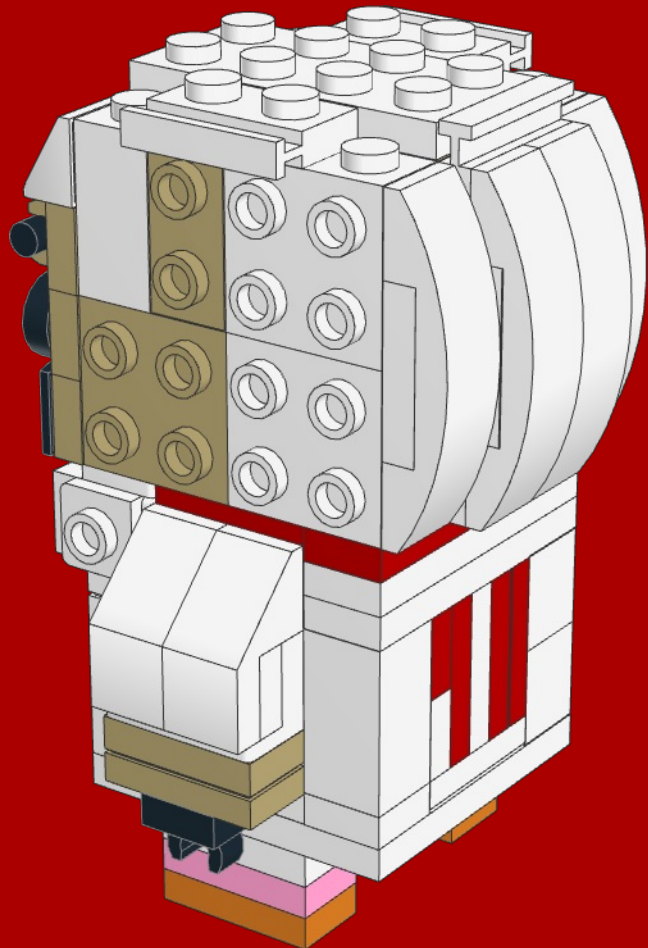
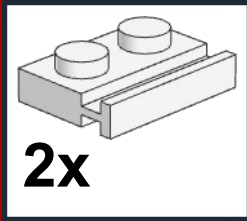

43

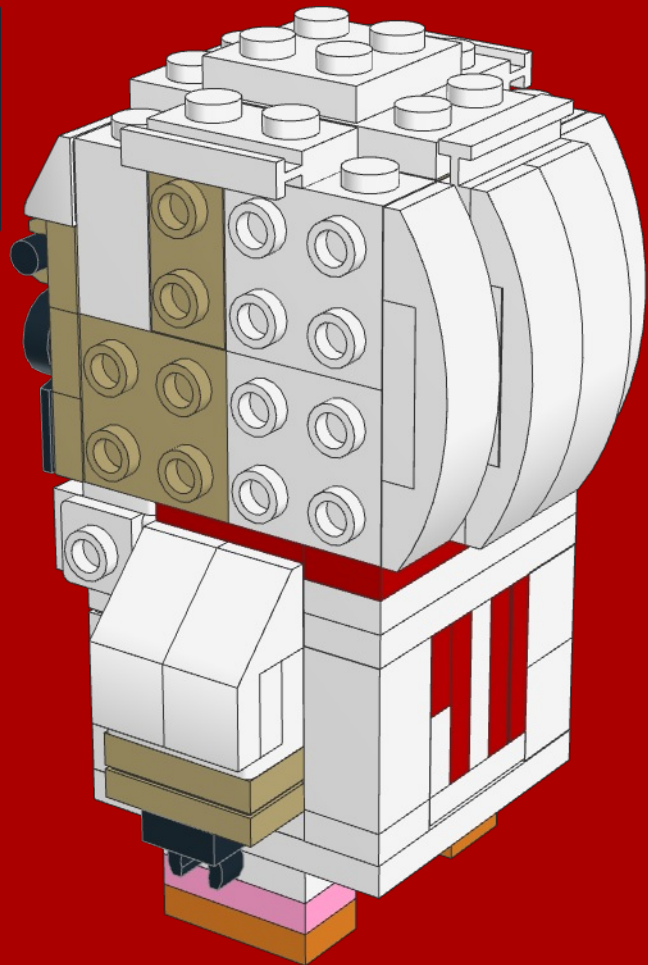
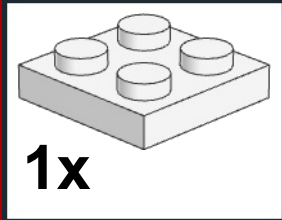



46

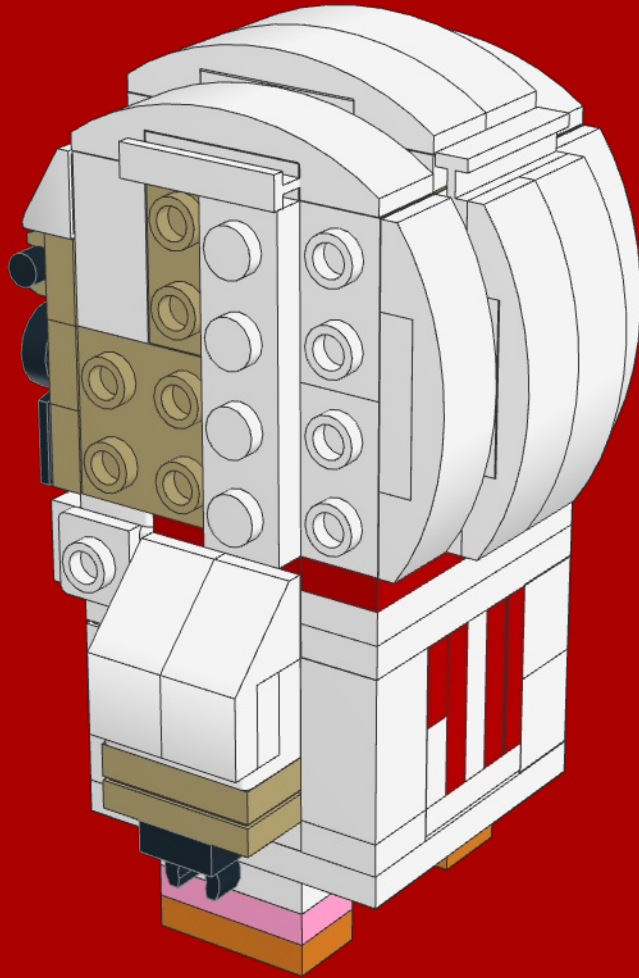
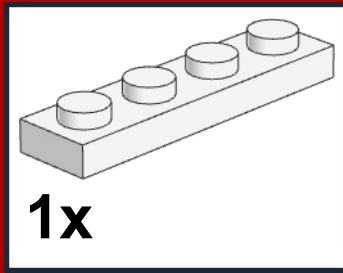

47

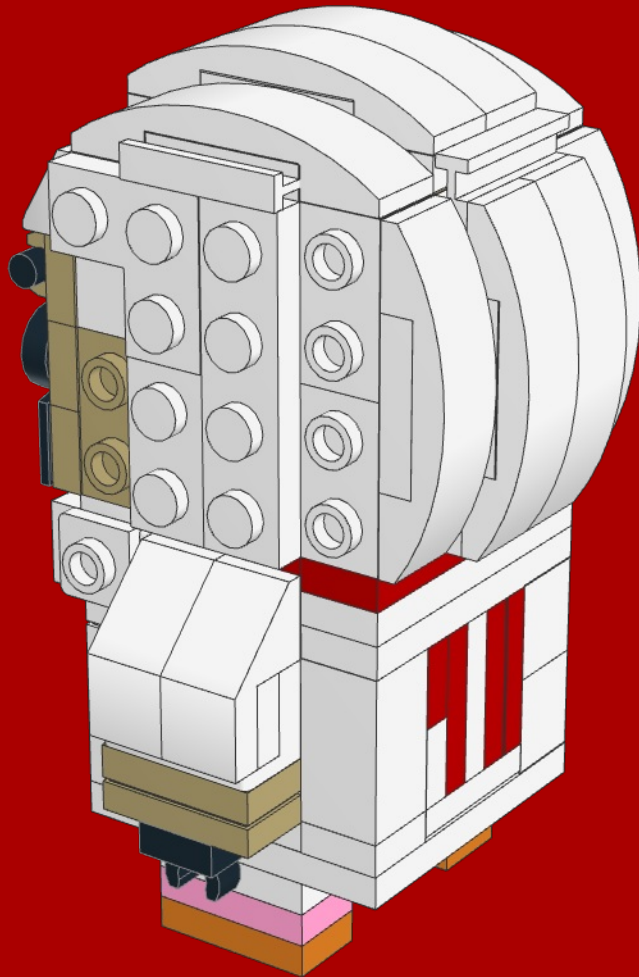
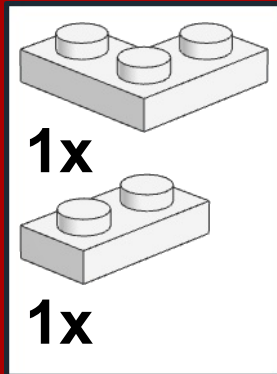

48

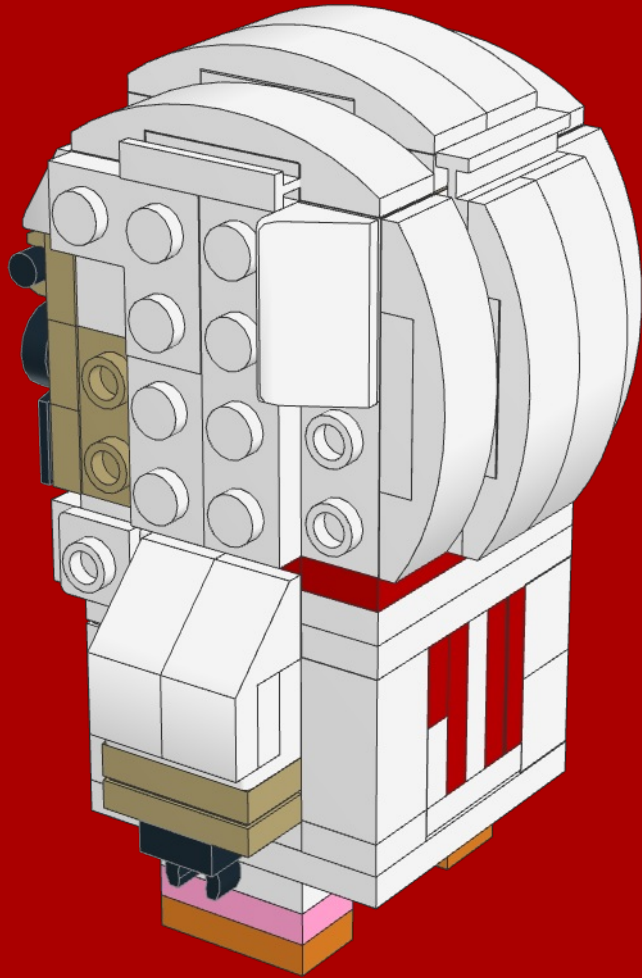
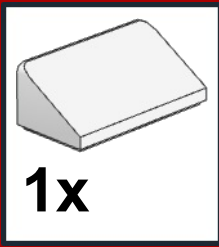

49

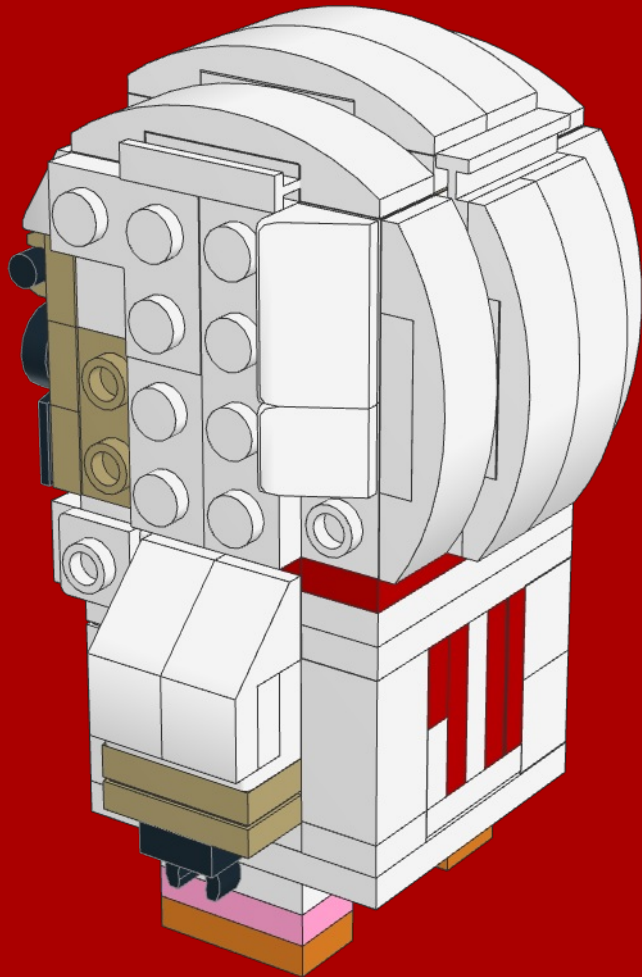
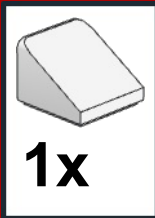



50

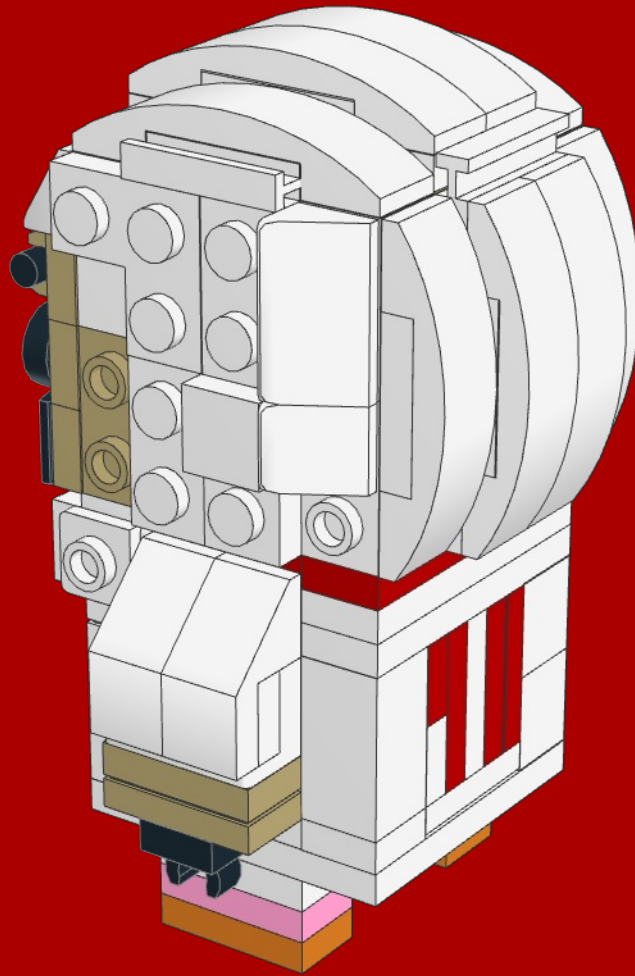
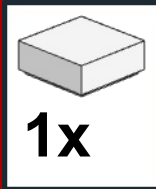

51

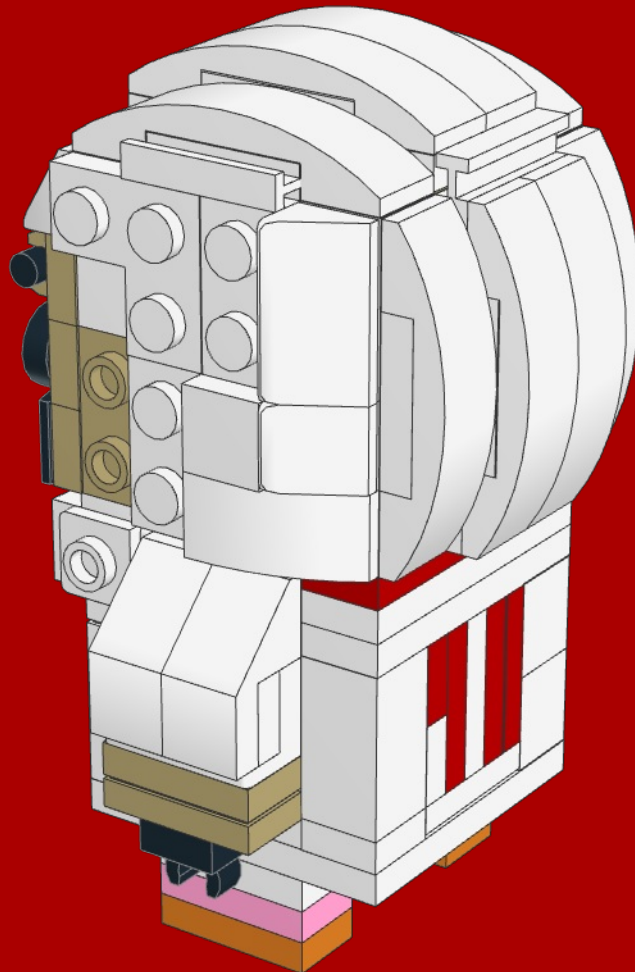
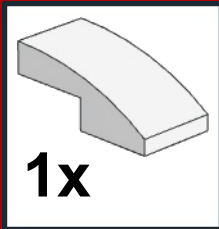

52

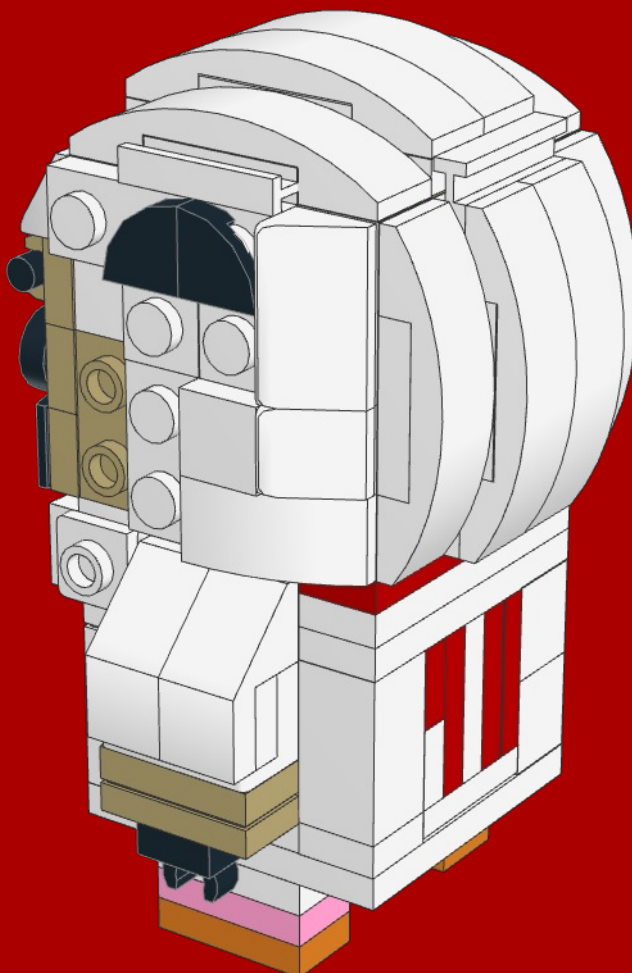

53

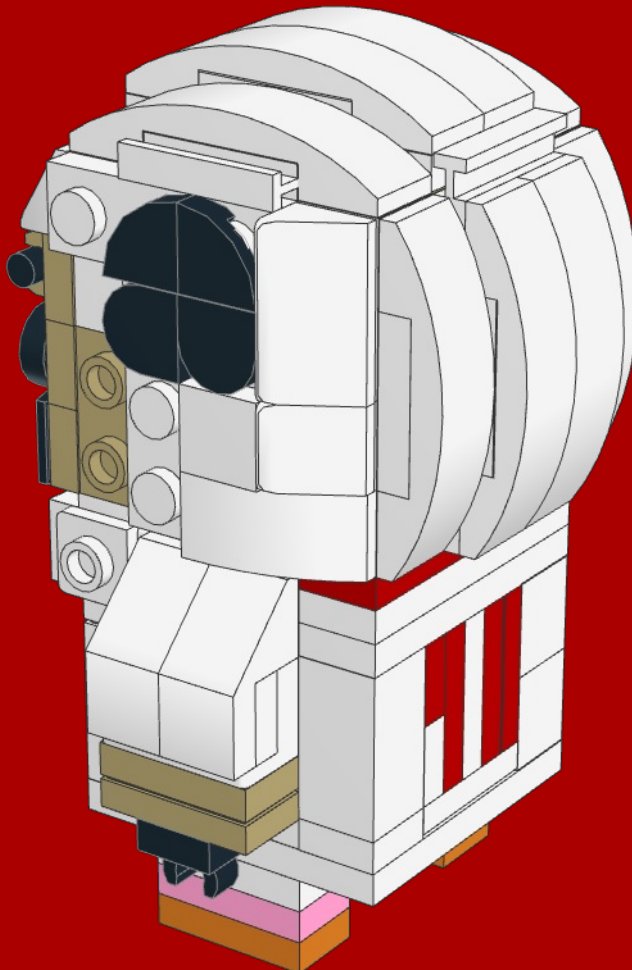

54

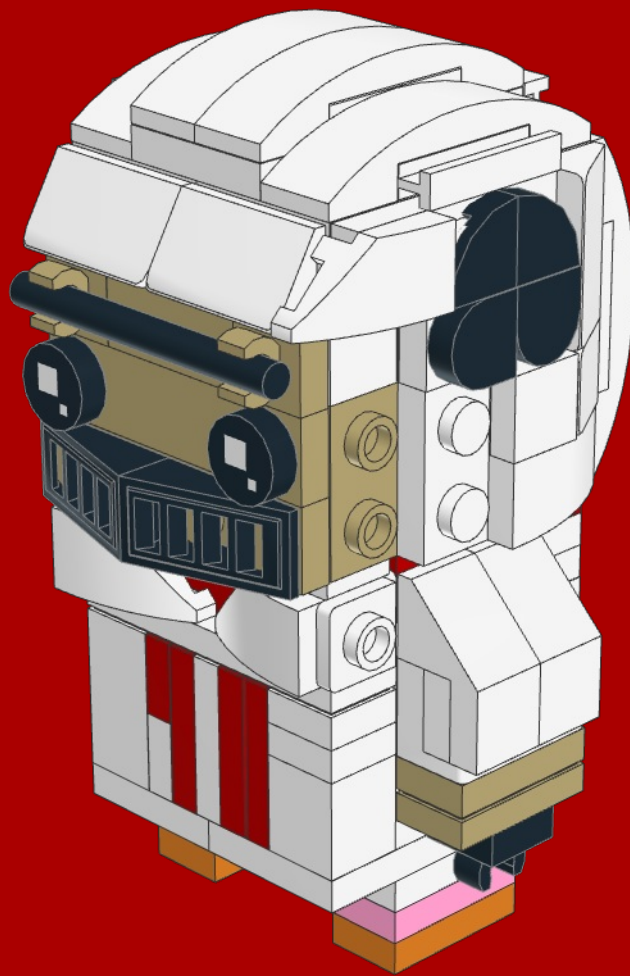
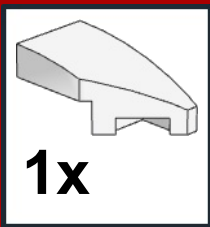

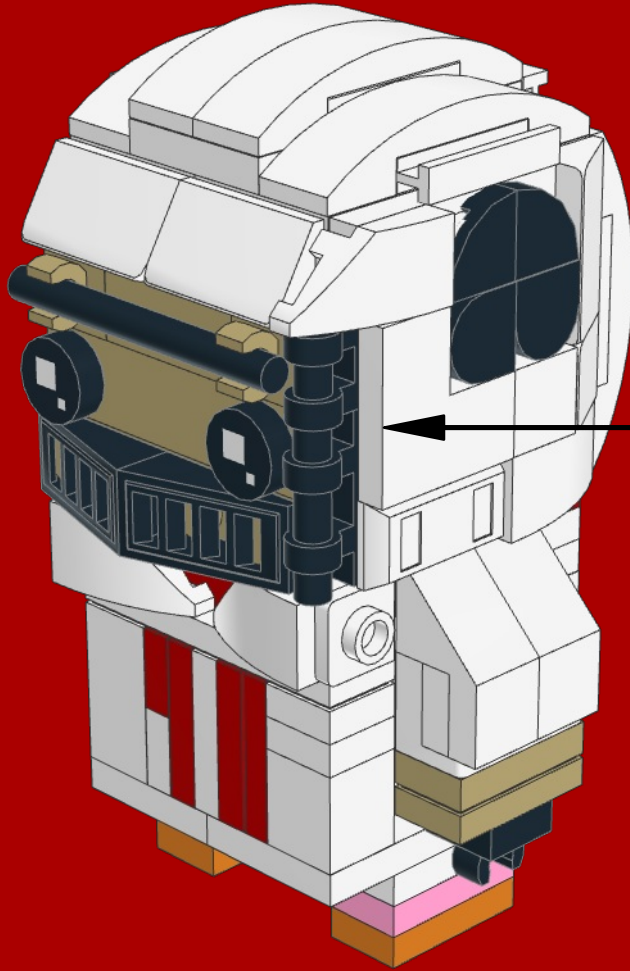

1

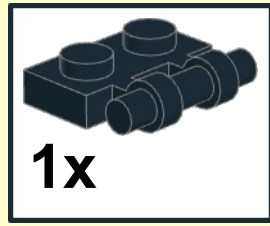

2

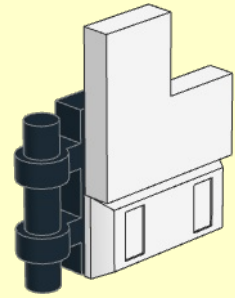
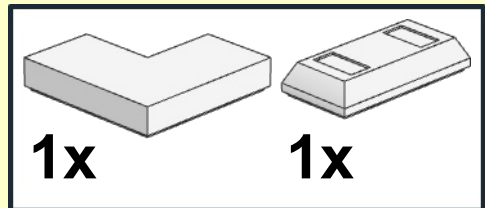

3

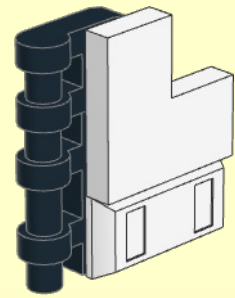

56

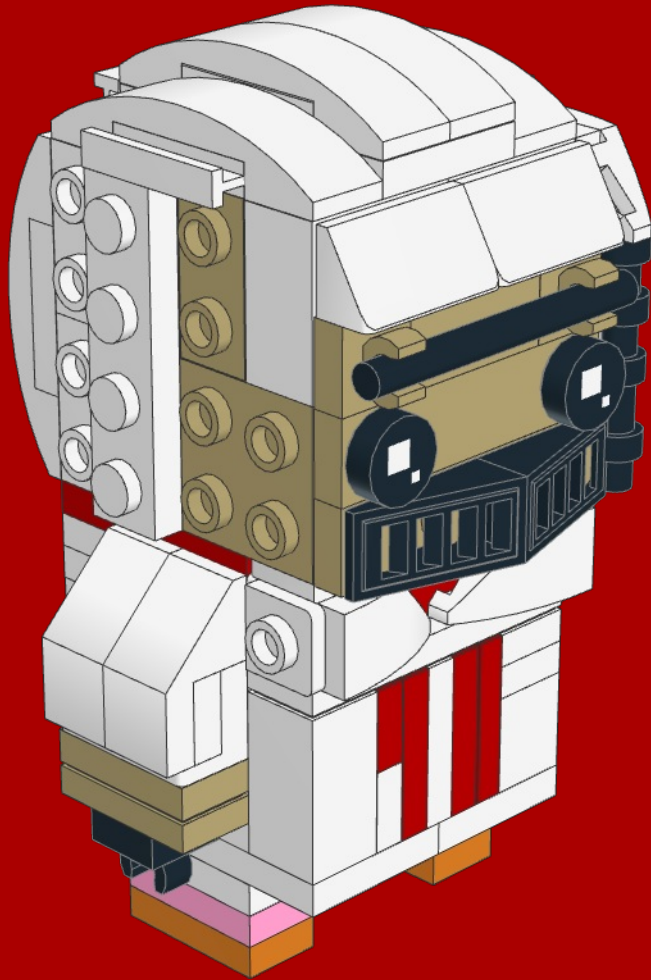
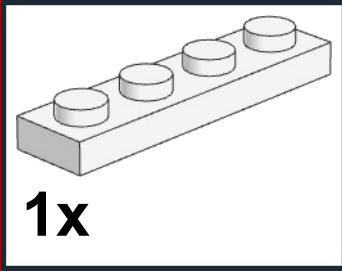

57

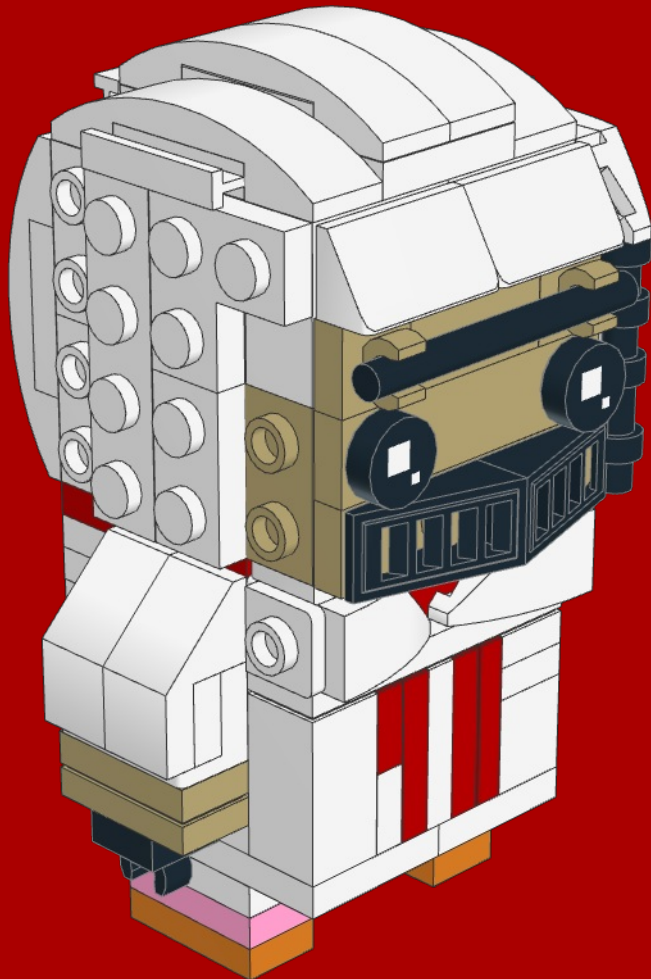
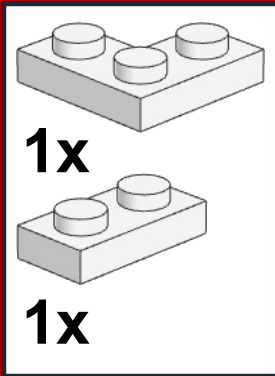

58

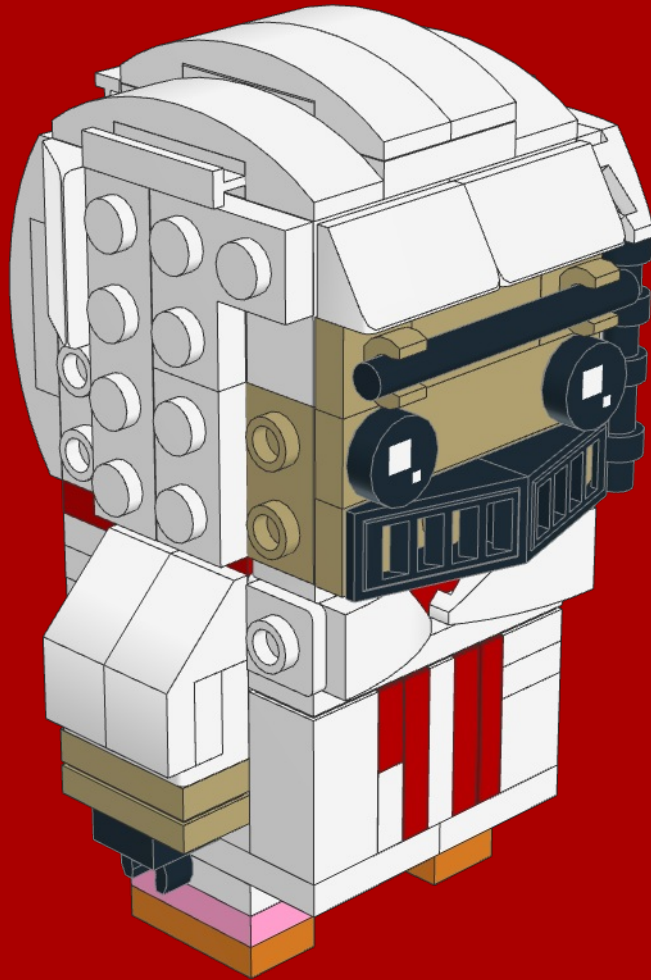
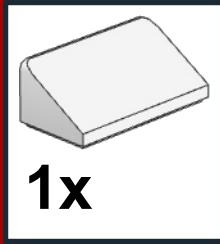

59

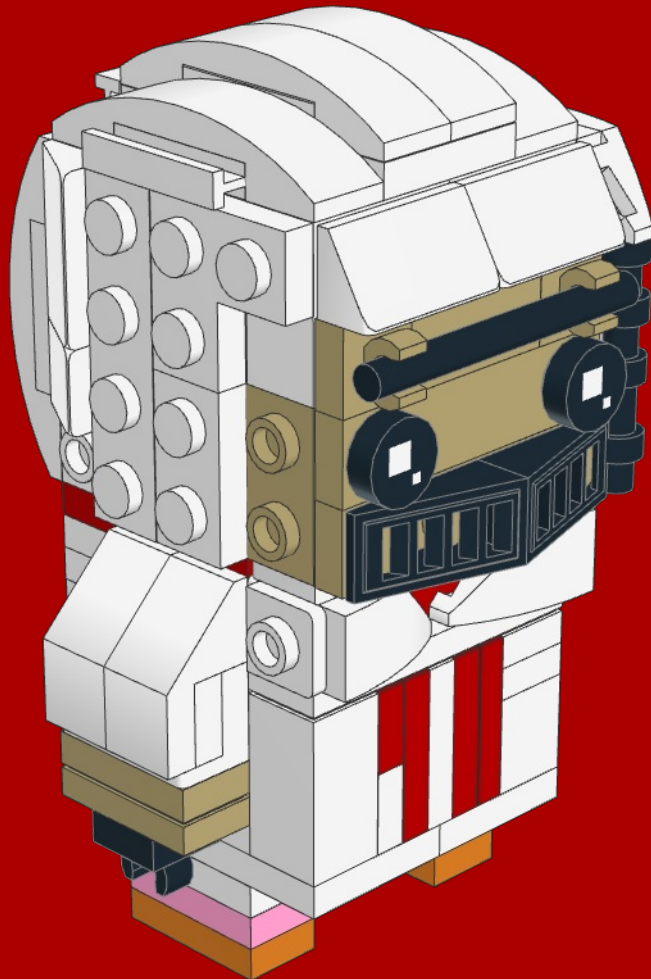
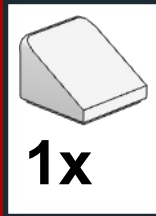

60

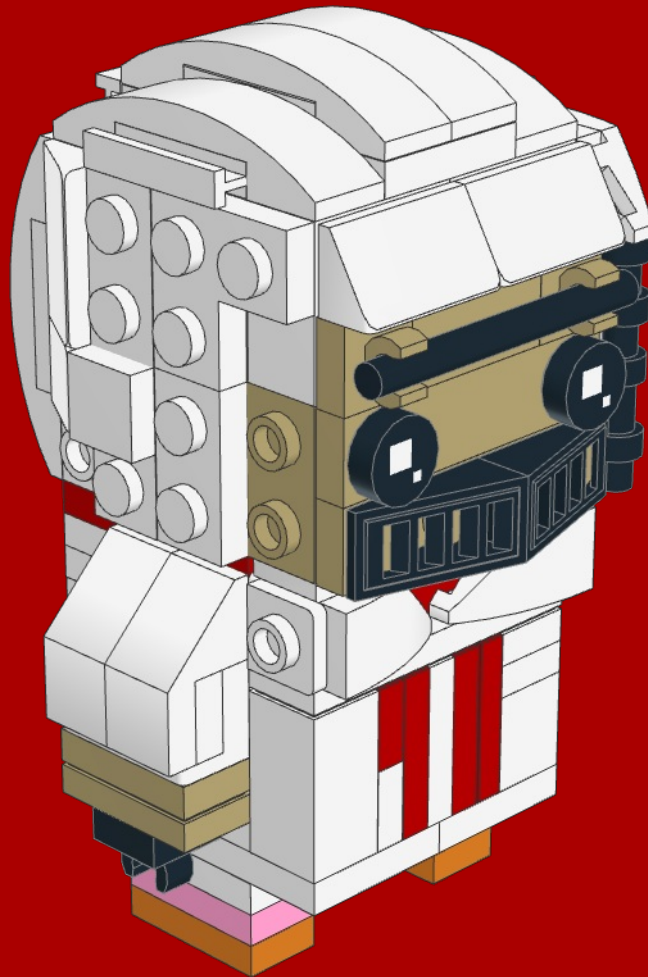
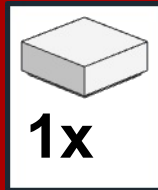

61

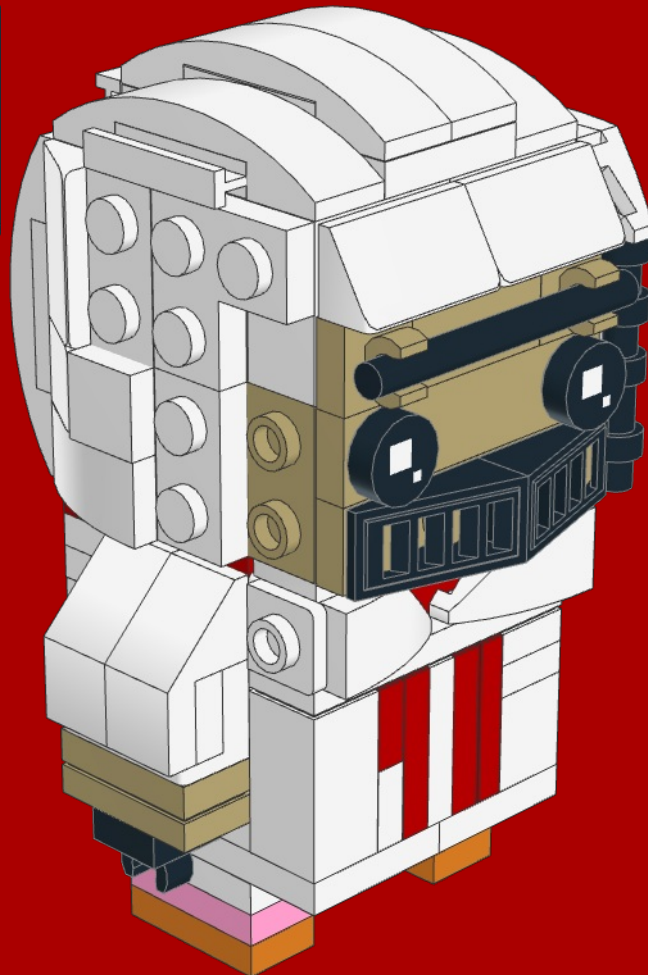
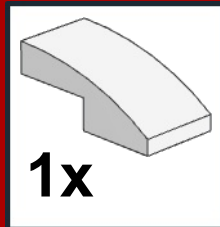

62

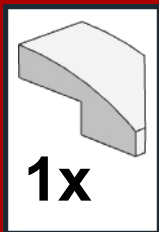

1x

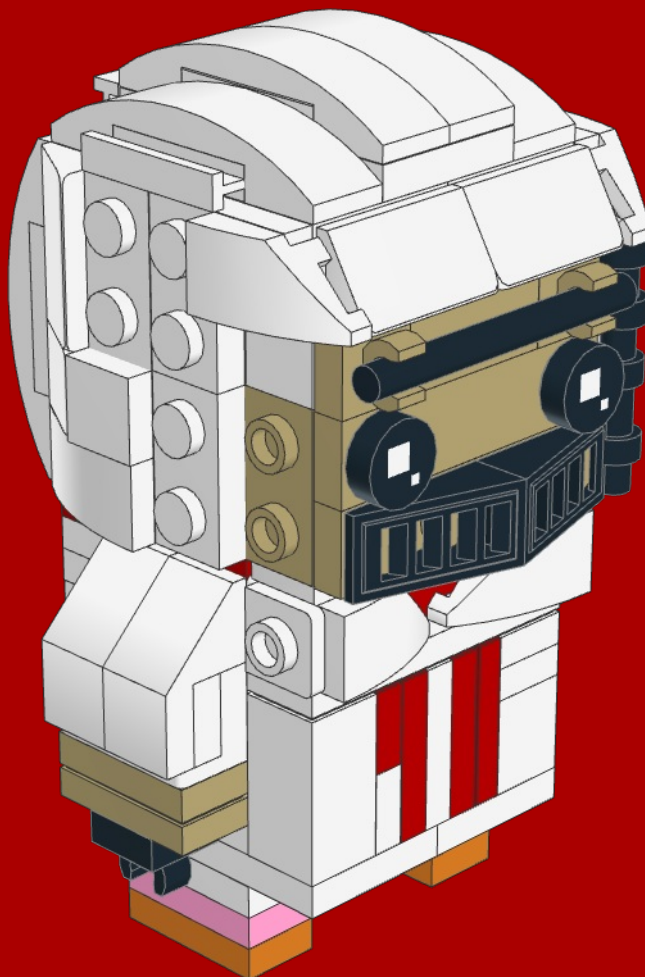

63



2x

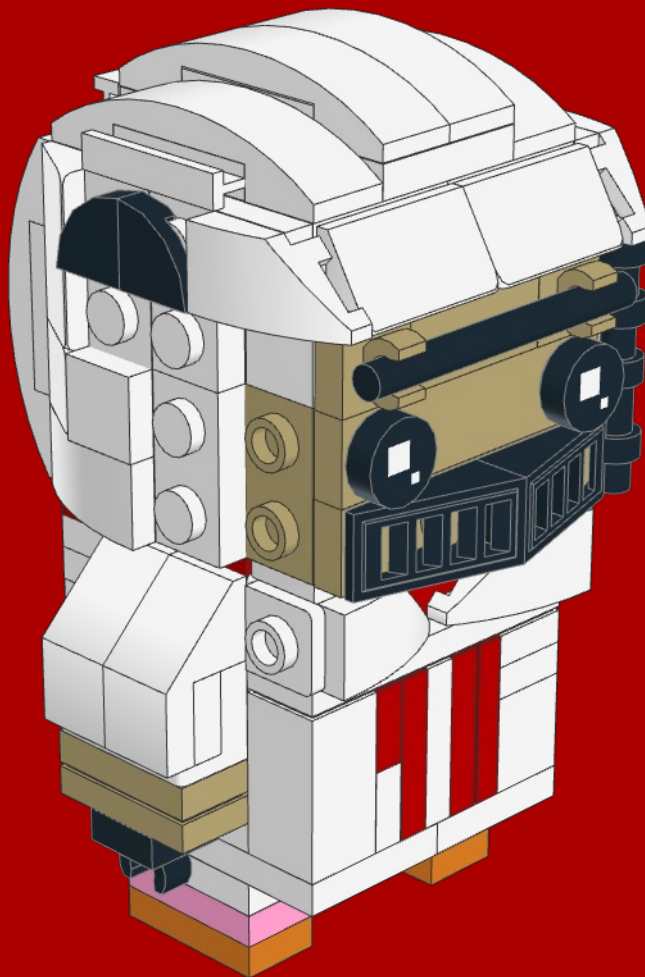



64  2x

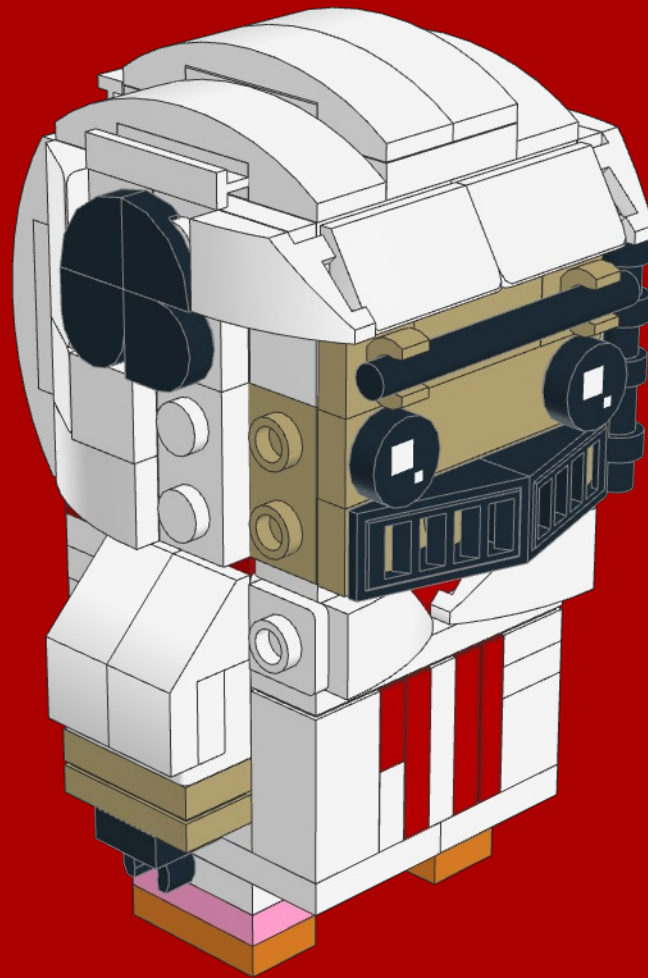

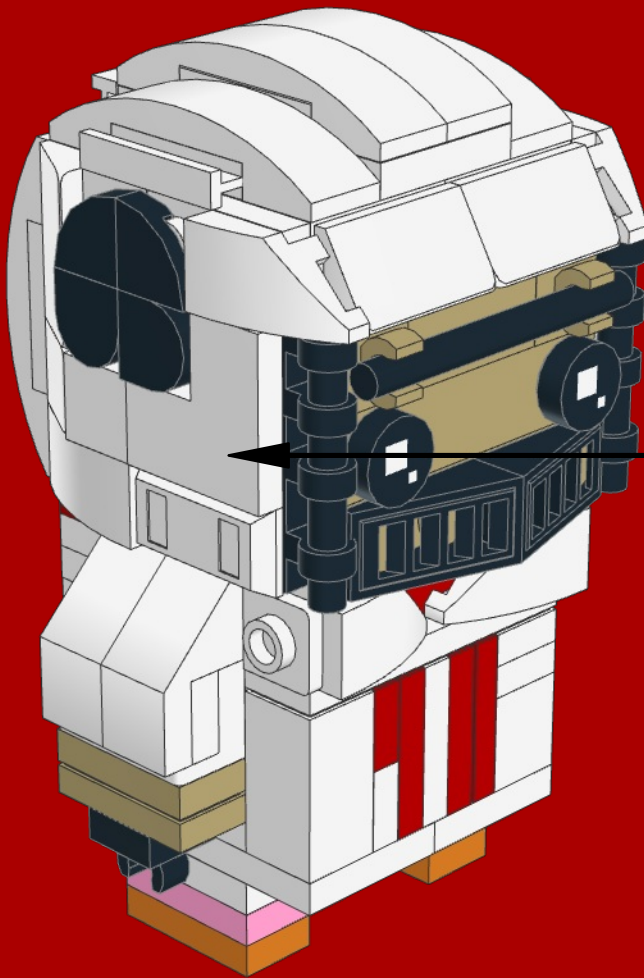

1

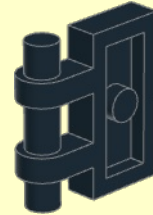
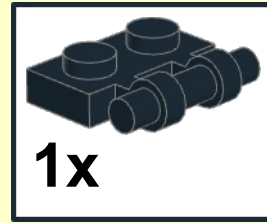

2

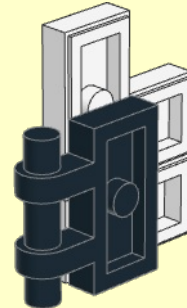
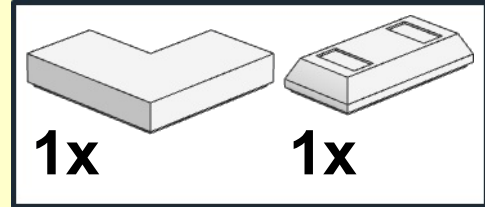

3

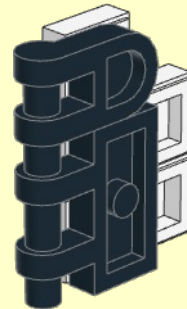

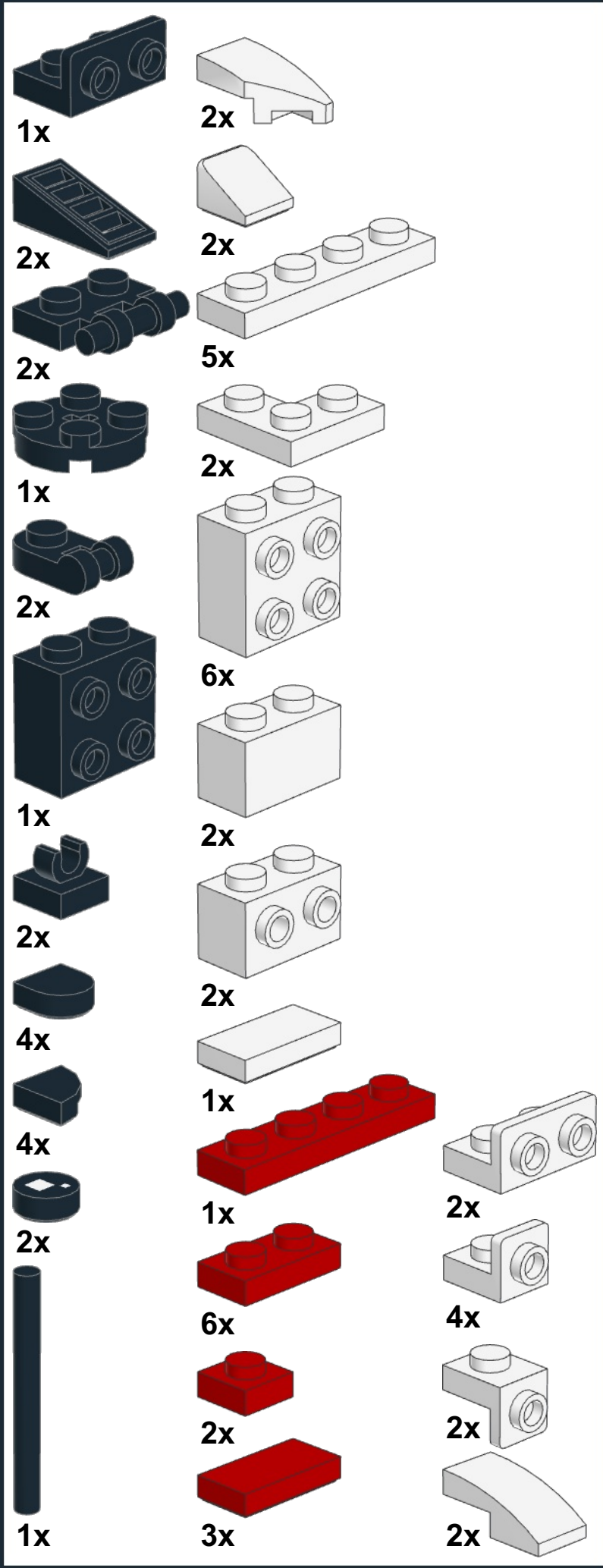

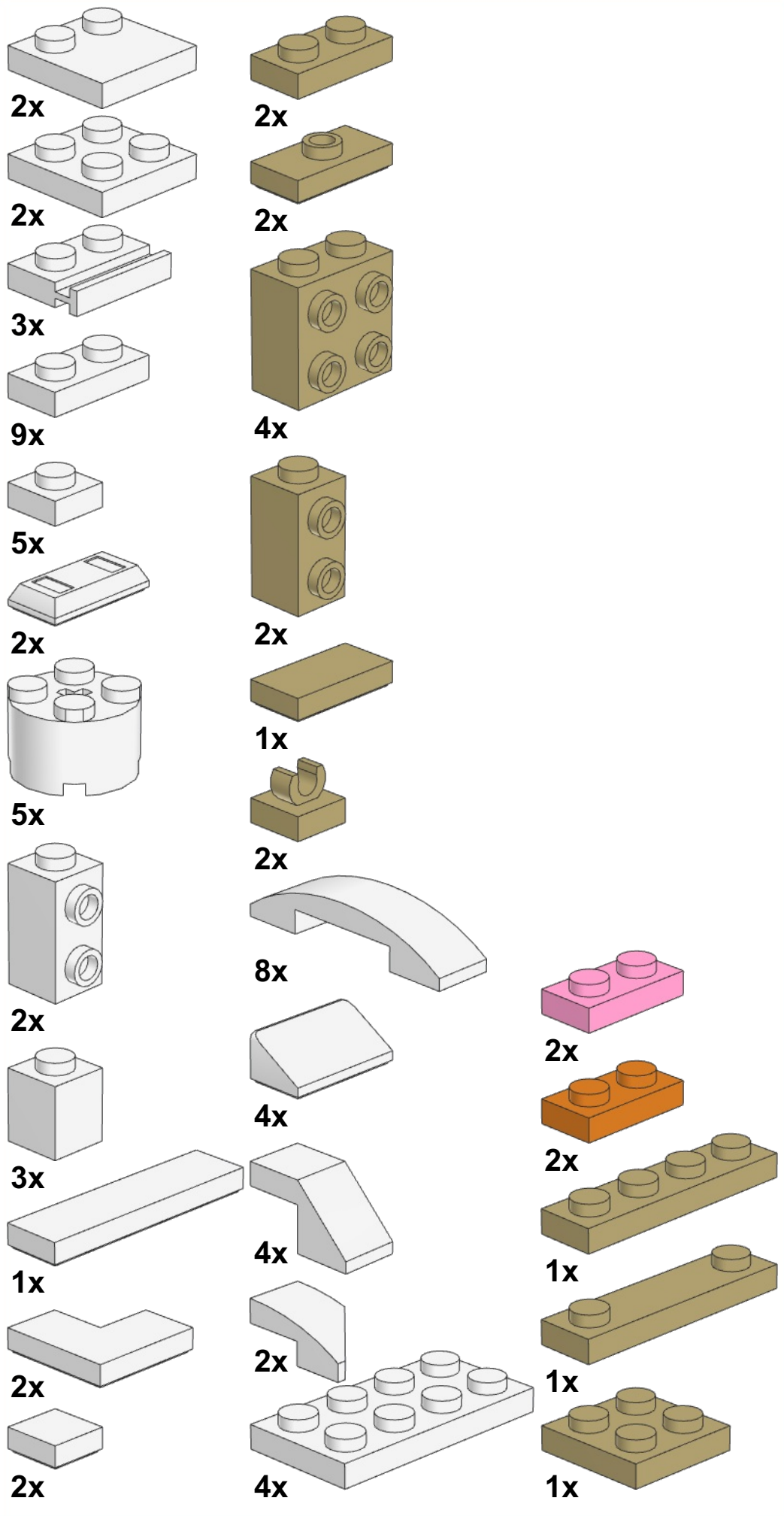

# *Honorable mentions of contributors:*

Teg12345



Hope you had fun with this model and instructions.

As always you can reach out to me via email:

[birdbrickbuilds@gmail.com](mailto:birdbrickbuilds@gmail.com)

You can also check my work on rebrickable and instagram:

<https://rebrickable.com/users/birdbrickbuilds/>

<https://www.instagram.com/birdbrickbuilds/>

If you wish to help me continue to make this models and instructions you can buy me a coffee to help me stay up late:

<https://www.buymeacoffee.com/birdbrickbl>

**LEGO® is a registered trademark of the LEGO Group, which does not sponsor, endorse, or authorize these instructions or the model they depict.**



This work is licensed under a [Creative Commons Attribution-NonCommercial-ShareAlike 4.0 International License](https://creativecommons.org/licenses/by-nc-sa/4.0/).

Instructions configured and generated using LPub3D 2.4.3.0.2557  
Download LPub3D at <https://trevorsandy.github.io/lpub3d/>

